

HOT

PRODUCTS

2016

CATALOG

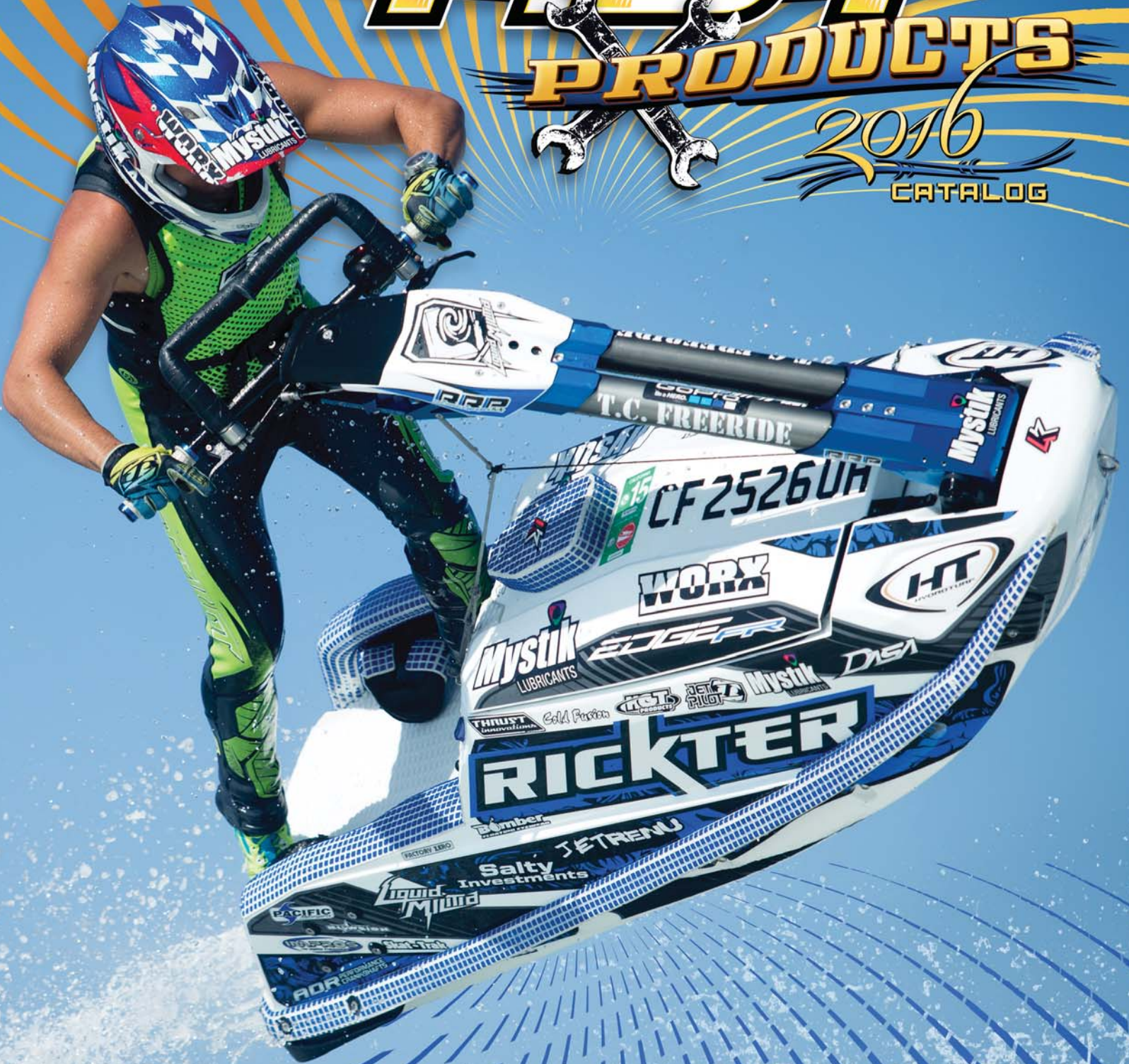

THE PREMIER
WORLDWIDE PERSONAL
WATERCRAFT PARTS DISTRIBUTOR

To our valued dealers worldwide,

Each year when we embark on our largest project of the year, the Hot Products catalog, we have the ultimate goal of creating the most complete, easy to use and accurate catalog in the industry. Our catalog allows you to order the parts you need, and we fulfill your orders correctly each and every time.

We spend months each year communicating with vendors and our dealers to make the updates for the new catalog. Once again, we have made many changes and improvements to create our largest catalog yet, 342 total pages.

The 2016 catalog features these updates:

Hydro-Turf: For 2016, Hydro-Turf has implemented a new seat cover program that has three options for each seat cover, allowing simple, fast and accurate ordering.

- Option A: All black seat cover
- Option B: Pre-selected color seat cover
- Option C: Custom Color seat cover

See pages 273-277 for all the new Hydro-Turf information and options.

Jettrim: A complete list of Jettrim seat covers in pre-selected colors and patterns has been added. New fabric swatches and colors allow you to see the complete line of Jettrim fabrics and colors available to create your custom seat cover.

See pages 266-272 for all the new Jettrim information and options.

Seat cover templates: To order a custom Hydro-Turf or Jettrim seat cover requires a template, we have compiled a complete collection of all the templates and created easy to use and understand preformatted templates to be used each time you order a seat cover. The templates have been uploaded to our website (www.HotProductsUSA.com) and can be accessed, downloaded and printed. These templates will insure the seat cover is accurately ordered, manufactured and shipped to you each time.

Skat-Trak impellers: Each year Skat-Trak develops the newest impeller and tools to install the impellers; this process evolves very quickly each year and creates confusion when ordering during the busy season. With the help of Michelle and Glen of Skat-Trak we have developed a



completely updated list of the Skat-Trak tools available and the application for each of these tools.

See pages 174-175 for all the new Skat-Trak information and options.

Wiseco: We have updated the models for each piston and added the new pistons that have been released, so you will be able to order the piston to fit your exact application.

See pages 140-144 for all the new Wiseco information and options.

New Products and manufacturers for 2016:

- Rhaas Products
- Motor mounts (see page 149)
- Engine conversion kits (see page 94)

- ODI grips
- New colors (see page 262)

IPD Graphics:
Information and ordering instructions (see page 290)

PWC Doctor:
New Versiplug-Race, Versiplug-Max HiFlow, Versiplug-Rickter (see pg 248)

Gator Guard:
PWC Keel protection (see page 288)

We strive to improve our business and customer service each and every day. Thank you for your business,

Scott Saito – Hot Products Founder and President



ADDRESS

8830 Rehco Road, Suite #F
San Diego, CA 92121

PHONE

1-858-453-4454

FAX

1-858-453-2046

HOURS

9:00am - 5:00pm

Pacific Standard Time, Monday - Friday

E-MAIL:

Scott@HotProductsUSA.com
(International Orders)

Tom@HotProductsUSA.com
(Domestic Orders)

TERMS/SHIPPING USA

All orders require a Visa, MasterCard, Discover or American Express (starting Summer 2016) credit card payment to release the order for shipment. COD shipments are available but must be approved by Hot Products when the order is placed. **All COD orders will incur a \$12.50 COD Service Charge** (the actual UPS COD Fee) if the order is not paid via credit card. All residential deliveries will incur a \$5.00 residential surcharge.

All orders will be shipped via UPS Ground unless otherwise requested. **Hot Products offers free UPS Ground shipping on all orders of \$250.00 or more** within the continental USA (Excluding Alaska, Hawaii, Guam, Puerto Rico). The following items are exceptions to the free freight policy and do not qualify: Beach Stands, Launcher Totes, Lifesled and other oversized items. The UPS Ground rate will be credited against the UPS Air Freight charges on all qualifying free UPS Ground orders. *All shipping rates are the published UPS rates.

Hot Products does not have a minimum order, all orders are accepted.

EXPORT SERVICES

The parent company of Hot Products, Exceed International Inc. has over 30 years of World Wide Export experience. In conjunction with the ability to purchase from the aftermarket watercraft industry manufacturers for export, Exceed International can process and package one easy and convenient shipment to expedite the shipment process and save on your shipping/export fees.

©2016 Hot Products USA. All Rights Reserved.

No reproduction or republication of information and/or images allowed without written permission.

Cover Photographs by: PhotoByBernard
Featured Sponsored Rider: Mark Gomez

VISIT OUR WEBSITE AND FOLLOW US ON FACEBOOK TO RECEIVE PRODUCT AND INDUSTRY INFORMATION

www.HotProductsUSA.com

Hot Products

PROUDLY SUPPORTING PWC RACING & EVENTS AROUND THE WORLD



2016 Hot Products IJSBA Mark Hahn Memorial Havasu 300 Mile Endurance Race The Longest One Day Endurance Race in the World!

The 2016 race will be the 12th anniversary of this great event, set to launch from Crazy Horse Campground in Lake Havasu City, Arizona, on February 27, 2016.

12th Annual
Hot Products
MARK HAHN Memorial
Havasu 300

Last year was a huge success, with 64 race entries from 14 countries, this has become a world-class event. Manufacturers view this as one of the most prestigious events and set their goals each year to be the overall manufacturer champion, an honor which Kawasaki took



Photo courtesy of PWCoffshore.com



home in both Runabout and Standup overall.

2015 Overall Champions
Runabout Overall: **Jean Bruno Pastorello & Jean-Baptiste Botti**
Kawasaki Ultra

Each year the race is held in the memory of endurance racer Mark Hahn, who was instrumental in providing the momentum to keep endurance racing going strong and growing across the country before his untimely death during a PWC race in 2004. The "Team" format features two riders for runabout (sit down) boat teams and up to three riders for a stand-up craft. Solo riders are also welcome to "Ironman" the race on either style of boat, a real test of endurance and stamina of both the riders and their race craft.

Stand-Up Overall Class Team: **Bibi Carmouche & Kody Copenhaver**
Kawasaki 800 SXR

For International racers that would like to race this event and need assistance for importing and equipment in Lake Havasu please call: T1R • Christophe/Karine (928) 230-3344.

We look forward to seeing everyone at the races in 2016.

2016 Hot Products IJSBA PWC Endurance "Triple Crown of Offshore" Series

Round # 1 - Sunday, May 22
The Hot Products Triple Crown of Offshore - Dana Point to Oceanside & Back (DP20)

Round # 2 - Sunday, July 17th
The Hot Products Triple Crown of Offshore - The IJSBA Offshore Endurance National Championships - Long Beach to Catalina (LB2CAT)

Round # 3 - Sunday, September 11th
Final Round of The Hot Products Triple Crown Of Offshore - TBA



(Note: Must have minimum of 25 entries for all Triple Crown races to move ahead three weeks prior to each race)

Hot Products VIP IJSBA WORLD FINALS

To show appreciation to our dealers, vendors and sponsored riders from around the world, Hot Products will have our Hot Products VIP Lounge at the 2016 Quakysense IJSBA World Finals.

This is our opportunity to take time to sitdown and meet in person to discuss business, new products and reflect on the season outside of the busy World Finals Vendor Alley.

The 2016 Quakysense IJSBA World Finals will be held in Lake Havasu City, Arizona USA from October 1st-9th, 2016.

Thank you to all of our VIP Lounge sponsors, without their support we would not have such a great VIP



Lounge. We look forward to seeing everyone at the 2016 Quakysense IJSBA World Finals.

The Hot Products VIP Lounge will be open on Friday October 7th thru Sunday October 10th.

Due to the limited space and availability, VIP Lounge access is by invitation only.

FOUR STROKE
INTAKE SYSTEMS
ENGINE/GASKETS
EXHAUST
DRIVE LINE HANDLING
ELECTRICAL
WATERLINE /BILGE
STEERING & CONTROLS
BODY
ACCESSORIES SERVICE TOOLS /HARDWARE
CHEMICAL

OIL CHANGE MAINTENANCE FOR 4-STROKE ENGINES

SEA-DOO 4 TEC OIL FILTER & PARTS

For All Sea-Doo 4-Tec

Description	OEM#	Part No.
K&N Performance Oil Filter	420956741	KN556
WSM OEM Replacement Oil Filter	420956741	006-560

Description	OEM#	Part No.
WSM OEM Replacement Aluminum Filter Cap	420612080	006-562
A. Oil Filter O-Ring (Sold in 5-pack)	420950860	25-1576E1
B. Oil Filter O-Ring (Sold in 5-pack)	420850500	25-1576E2
C. Oil Filter O-Ring (Sold in 5-pack)	420230920	25-1576E3
Oil Filter O-Ring Set (One each of 25-1576E1, 25-1576E2 and 25-1756E3)	420950860 420850500 420230920	25-1576



SEA-DOO SPARK OIL FILTERS

Description	OEM#	Part No.
WSM OEM Replacement Oil Filter	420956123	006-559

KAWASAKI 4-STROKE OIL FILTERS

All Kawasaki 4-Stroke STX12F/15F, Ultra 250X/260X/300X/310X and Ultra LX (OEM# 16097-0003 and 16097-0004)



Description	Part No.
K&N Performance Oil Filter for all Kawasaki 4-Stroke	KN204
WSM OEM Replacement Oil Filter for all Kawasaki 4-Stroke	006-563

*Kawasaki engine has tight space around oil filter area and the shorter filter, such as KN204/006-563 are recommended for easy installation.

HONDA AQUATRAX 4-STROKE OIL FILTERS

For all years Honda Aquatrax (OEM# 15410-MFJ-D01)



Description	Part No.
WSM OEM Replacement Oil Filter for all years Honda Aquatrax	006-563

YAMAHA 4-STROKE OIL FILTERS

Model	CC	Year	OEM#	K&N	WSM	Pro-Marine
FX 140 A	998	2002	5GH-13440-00-00	KN303	006-563	N/A
FX140 WAVERUNNER 3-PERSON	998	2003	5GH-13440-00-00	KN303	006-563	N/A
FX CRUISER 2-PASS	998	2003	5GH-13440-00-00	KN303	006-563	N/A
FX1000 FX140 3-PERSON	998	2004	5GH-13440-00-00	KN303	006-563	N/A
FX1000A FX CRUISER 3-PERSON	998	2004	5GH-13440-00-00	KN303	006-563	N/A
FX1100 FX HO 3-PERSON	1052	2004	5GH-13440-00-00	KN303	006-563	N/A
FX1100 FX CRUISER HO 3-PERSON	1052	2004	5GH-13440-00-00	KN303	006-563	N/A
VX1100 SPORT	1052	2005	5GH-13440-00-00	KN303	006-563	N/A
VX1100 DELUXE	1052	2005	5GH-13440-00-00	KN303	006-563	N/A
WAVERUNNER FX HO	1052	2005	5GH-13440-00-00	KN303	006-563	N/A
WAVERUNNER FX CRUISER HO	1052	2005	5GH-13440-00-00	KN303	006-563	N/A
FX 3-Person	1052	2005-2007	5GH-13440-00-00	KN303	006-563	N/A
FX Cruiser 3-Person	1052	2005-2007	5GH-13440-00-00	KN303	006-563	N/A
VX110 Sport 3-Person	1052	2006	5GH-13440-00-00	KN303	006-563	N/A
VX110 Deluxe 3-Person	1052	2006	5GH-13440-00-00	KN303	006-563	N/A
FX HO 3-Person	1052	2006	5GH-13440-00-00	KN303	006-563	N/A
FX Cruiser HO 3-Person	1052	2006-2007	5GH-13440-00-00	KN303	006-563	N/A
FX Crsr HO Anniv 3-Person	1052	2006-2007	5GH-13440-00-00	KN303	006-563	N/A
VX 3-Pass	1052	2007	5GH-13440-00-00	KN303	006-563	N/A
VX Sport 3-Pass	1052	2007	5GH-13440-00-00	KN303	006-563	N/A
VX Cruiser 3-Pass	1052	2007	5GH-13440-00-00	KN303	006-563	N/A
VX Deluxe 3-Pass	1052	2007	5GH-13440-00-00	KN303	006-563	N/A
FX	1052	2008	5GH-13440-20-00	KN204		
FX Cruiser	1052	2008	5GH-13440-20-00	KN204		
FX HO 3-Pass	1052	2008	5GH-13440-20-00	KN204		
FX Cruiser SHO	1812	2008-2010	69J-13440-01-00	N/A	006-564	18-7906
FX SHO	1812	2008-2013	69J-13440-01-00	N/A	006-564	18-7906
FX CRUISER HO	1812	2009-2013	69J-13440-01-00	N/A	006-564	18-7906
FX HO	1812	2009-2013	69J-13440-01-00	N/A	006-564	18-7906
FZS	1812	2009-2013	69J-13440-01-00	N/A	006-564	18-7906
FZR	1812	2009-2013	69J-13440-01-00	N/A	006-564	18-7906
VX 3-Pass	1052	2008-2011	5GH-13440-20-00	KN204		
VX Sport 3-Pass	1052	2008-2011	5GH-13440-20-00	KN204		
VX Cruiser 3-Pass	1052	2008-2011	5GH-13440-20-00	KN204		
VX Deluxe 3-Pass	1052	2008-2011	5GH-13440-20-00	KN204		
WaveRunner VXR	1812	2011-2013	69J-13440-01-00	N/A	006-564	18-7906
WaveRunner VXS	1812	2011-2013	69J-13440-01-00	N/A	006-564	18-7906
WAVERUNNER VX CRUISER	1052	2012-2013	5GH-13440-20-00	KN204		
WAVERUNNER VX DELUXE	1052	2012-2013	5GH-13440-20-00	KN204		
WAVERUNNER VX SPORT	1052	2012-2013	5GH-13440-20-00	KN204		
TR1	1052	2016	5GH-13440-50-20	KN204		



OIL CHANGE MAINTENANCE FOR 4-STROKE ENGINES



HYDRO-TURF OIL EXTRACTOR

Description	Capacity	Part No.
A. Hydro-Turf Oil Extractor	6 liter (1.57 gal)	OIL01
B. Hydro-Turf Oil Extractor	15 liter (3.92 gal)	OIL03



Adapter Kit Included!

FLUID EXTRACTOR

Description	Capacity	Part No.
Moeller Fluid Extractor	7.0 liter (7.2 qt)	035340
Fluid Extractor Tube Replacement Kit (3 tubes/kit)		035800

*Note: Not for use with gasoline.

- No power required
- Dual action vacuum pump saves time
- Easy-to-carry handle, foot stabilizing features
- Extracts warm or cold oil
- No-mess design includes tethered cap and easy-pour spout
- Manual pressure relief valve prevents burps and spills
- Automatic shut-off float eliminates overflow



SCEPTER FLEXIBLE FUNNEL

Scepter's flexible funnel is perfect for all your PWC uses and really helps perform those difficult maintenance and repair applications. Manufactured from quality, high density polymers: the funnel won't rust, dent, or crack. This means no drips and leaks for you to clean up after your done. The funnel length is 18".

Description	Part No.
Scepter 18" Flexible Funnel	MR03603



OIL FILTER MAGNET FOR 18, 20, 22MM (3/4"-13/16") HOLE SIZE

- Easy to install, just attach to base of standard oil filter
- Standard oil filter only trap particles down to 20 microns, leaving the most harmful 5 to 20 micron particles to circulate through your engine.
- This powerful magnet traps harmful, abrasive hard metal particles down to 1 micron that regular oil filters don't
- A must have item during engine break in

Description	Part No.
Oil Filter Magnet	11-0064

JABSCO ELECTRIC OIL CHANGER



- | | |
|----------------|---|
| Pump Body: | Polypropylene |
| Diaphragm: | Geolast™ oil resistant |
| Valves: | Viton™ oil resistant |
| Motor: | 12V DC with integral power switch |
| Receiver: | Plastic with 3.5 gal (13.2 L) maximum capacity bucket |
| Battery Leads: | 6 ft. (1.8 m) with alligator clips |
| Suction Tube: | 8 ft. (2.4 m), oil & heat resistant |

Dimensions: 12-3/8" (314 mm) diameter, 12-3/4" (324 mm) high
Weight (empty): 6 lbs. (2.7 kg)

Description	Part No.
Jabco Oil Changer 13.2 liter (3.5 gal)	17850-1012

OIL FILTER STRAP WRENCH



- Fits all spin-on type oil filters
- Use with 3/8" drive ratchet or extension
- Can also be used to hold other cylindrically shaped parts
- Maximum strap diameter 125mm (5 inches)

Description	Part No.
Oil Filter Strap Wrench	08-0069

"LAST DROP" OIL EXTRACTION SYSTEM

- A typical oil change leaves 1.27 quarts of dirty oil in engine.
- This system allows removal of 99% of dirty oil during servicing.
- Cleaner oil delivers better lubricity & engine life.
- Quick and easy installation.
- Sturdy stainless steel & aluminum construction.
- Compatible with most popular engine oil extractor pumps.

Description	Part No.
Yamaha 1.8L engine:	RY10040-OES
2012 & newer 1.8L engine models (SVHO/SHO/HO), FZR models starting with engine #6AN1013200, VXR/VXS models starting with engine #6CN1005800	

4 STROKE	NATKE	ENGINE/	EXHAUST	ELECTRICAL	WATERLINE	STEERING	BODY	ACCESSORIES	SERVICE TOOLS	CHEMICAL
	SYSTEMS	GASKETS	HANDLING		/BLIGE	& CONTROLS		/HARDWARE		

SEA-DOO SPARK
INTAKE SYSTEMS
ENGINE/GASKETS
EXHAUST
DRIVE LINE HANDLING
ELECTRICAL
WATERLINE /BILGE
STEERING & CONTROLS
BODY
SERVICE TOOLS ACCESSORIES /HARDWARE
CHEMICAL



R&D POWER PLENUM FILTER KIT

The R&D Spark Power Filter Kit will add a noticeable increase in throttle response and overall power by opening up and allowing more air flow over the super restrictive O.E.M. air plenum box. The R & D Filter Kit incorporates and adds needed intake track length proven to increase overall torque and power on 4-stroke engines.

Description Power Plenum Filter, Spark
Part No. 203-00900

RIVA SPARK POWER FILTER KIT



RIVA's Power Filter feeds your Spark's engine with a steady diet of cool air delivering greatly improved acceleration and power. Precision-formed intake duct channels cool air from original hull vents to airbox. Cool air enters the system via an oversized K&N filter element. Installs quickly & easily with included instructions.



The Spark Power Filter draws cool air from the front of your craft that is supplied by the factory hull vents. Air is channeled past the fuel tank and into the OEM airbox.

Description RIVA Power Filter Kit, Spark
Part No. RS13130



STAINLESS STEEL SPARK HOOD WASHERS KIT

Replace the stock plastic hull washers which will break and deteriorate easily with stainless steel washers.

Description WORX Hull Washer Kit (21 Washers) **Part No.** WR06018-21
WORX Hull Washer Kit (31 Washers) **Part No.** WR06018-31
RIVA Engine Access Deck Kit (21 Washers) **Part No.** RS4-130-WUK-1
RIVA Front & Rear Deck Kit (31 Washers) **Part No.** RS4-130-WUK-2



RIVA SPARK ACCESS PANEL KIT

- Provides easy access to engine compartment
- Integrated fire extinguisher storage
- No visible modifications with seat in place

Description RIVA Sea-Doo Spark Engine Access Panel Kit
Part No. RS4-130-EAK
2-seater/3-seater model

R&D R3 ECU REPROGRAMMING



Part #803-01901 R&D Spark 60/90 R1 ECU...Reprogrammed ECU to allow up to 8250 running RPMs, upgraded (slightly advanced) ignition timing, safe for all recreational and offshore racing uses. R1 works great with 89 octane pump fuel. Top speed range for the R1 ECU is approximately 54-55 mph. R1 has increased low end power and a big gain in top speed. The R1 would be a great choice for offshore competition use.

Part #803-01902 R&D Spark 60/90 R2 ECU...Reprogrammed ECU to allow up to 8450 running RPMs, upgraded (slightly advanced) ignition timing, safe for all recreational and offshore racing uses. R2 works great with 89 octane pump fuel. Top speed range for the R2 ECU is approximately 54-55 mph. R2 has increased low end and mid range power over the R1 ECU Tune, and also a big gain in top speed.

Part #803-01903 R&D R3...Reprogrammed ECU to allow up to 8650 running RPMs, upgraded (more aggressively advanced) ignition timing, safe for all recreational and closed course racing uses. R3 works great with 91-93 octane pump fuel. Top speed range for the R3 ECU in R&D's Stock class/Stage 1 Kit Form range consistently in the 57-58 mph plus, even while using the R&D Aquavein Top Loader intake grate! R3 has increased low end power and top speed over the R2. Top end timing specs geared to safely run 91-93 octane fuel. Note: The R3 ECU is also offered in 8850, 9000, 9250 and 9500 rev limits.

Part #803-01904 R&D ECU PS-100...Developed specifically for Stock Class Competition. R&D reprograms the ECU to allow an operational RPM of 8650. PS-100 has aggressive racing ignition and fuel tables geared to pull extremely hard in the low through mid range power areas, and pull hard and quick to peak top speed. RPMs and top end timing specs geared to run 100+ octane racing fuel exclusively. Top speeds in R&D Stock Kit using the R&D PS-100 ECU will easily reach the 58+ mph range, depending on water type and conditions. The R&D PS-100 ECU is also offered in 8850, 9000, 9250 and 9500 rev limits.

ECU reflashing is recommended for competition use only.



RS12130-IMUK

WR04023

RIBBON REMOVER



Description RIVA Ribbon Remover, Spark **Part No.** RS12130-IMUK
WORX Ribbon Remover, Spark **Part No.** WR04023



RIVA SEA-DOO SPARK FREE FLOW EXHAUST KIT UTILIZING STOCK EXHAUST OUTLET

- Improved performance & reduced back pressure
- Mandrel bent aluminum tubing is powder coated to prevent corrosion
- Aluminum construction and high temp silicon couplers hold up to backfires & overheats
- Fits both 2 & 3 passenger Sea-Doo SPARK models

Description RIVA Free-Flow Exhaust Kit, Sea-Doo Spark **Part No.** RS16130



RIVA SEA-DOO SPARK REAR EXHAUST KIT UTILIZING STRAIGHT EXHAUST OUTLET

- Improved performance & reduced back pressure
- Large aluminum rear exhaust exit looks awesome!
- All components anodized and powder coated to prevent corrosion
- Fits 2 seater Sea-Doo SPARK only

Description RIVA Rear Exhaust Kit, Sea-Doo Spark **Part No.** RS15130



WORX SEA-DOO SPARK REAR EXHAUST KIT UTILIZING STRAIGHT EXHAUST OUTLET

- Increased throttle response through the rpm range
- Lightweight moulded silicone hose
- Billet anodized rear exhaust outlet
- Easy install with all hardware provided in kit
- Fits 2 seater Sea-Doo SPARK only

Description Worx Sea-Doo Spark Rear Exhaust Kit **Part No.** WR04004



R&D SEA-DOO SPARK HIGH FLOW EXHAUST UTILIZING STOCK EXHAUST OUTLET

The R&D High Flow Exhaust Kit improves low end and mid range power feel as well as adds top end performance! The R&D High Flow Exhaust Kit produces a cool performance sound to the Spark while maintaining a safe and under IJSBA and Coast Guard approved 86 db. Installs with no modifications to the hull.

Description R&D Sea-Doo Spark High Flow Exhaust **Part No.** 333-80900



RIVA SEA-DOO SPARK PRO-SERIES WATER BOX

Unique exhaust baffle design increases the low-end power and mid-range pull of your SPARK's 900cc engine. Delivers up to 5hp on modified engines along with significant torque gains. High-strength aluminum construction will survive backfires and meltdowns. Developed on our Dyno and tested extensively on the water, this water box features radiused exhaust tubes and dished end caps for optimum exhaust flow. Recommended for use with RIVA Free Flow Exhaust Kits or RIVA Rear Exhaust Kits. Includes detailed installation instructions.



Description RIVA Sea-Doo Spark Water Box **Part No.** RS16131



WORX SEA-DOO SPARK FREE FLOW EXHAUST KIT UTILIZING STRAIGHT EXHAUST OUTLET

- Increased throttle response and reduced back pressure
- Lightweight moulded silicone hose
- Easy install with all hardware provided in kit
- Fits 2 and 3 seater style Spark models including IBR models

Description Worx Sea-Doo Spark Free Flow Exhaust Kit **Part No.** WR04008

SEA-DOO SPARK	INTAKE SYSTEMS	ENGINE/GASKETS	EXHAUST	DRIVE LINE HANDLING	ELECTRICAL	WATERLINE /BILGE	STEERING & CONTROLS	BODY	ACCESSORIES	SERVICE TOOLS /HARDWARE	CHEMICAL
---------------	----------------	----------------	---------	---------------------	------------	------------------	---------------------	------	-------------	-------------------------	----------

113-96001



WR244

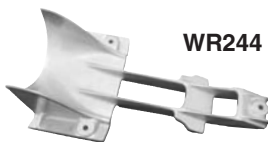

RS22130



INTAKE GRATES FOR SEA-DOO SPARK

Description	Part No.
R&D Aquavein, Spark	113-96001
RIVA Top Loader, Spark	RS22130
WORX Maxiloader, Spark	WR244



123-96002



WR555



RS26130

SPONSON KIT FOR SEA-DOO SPARK

Description	Part No.
R&D Pro Series Sponson, Spark	123-96002
RIVA Pro Series Sponson, Spark	RS26130
WORX Sponson, Spark	WR555

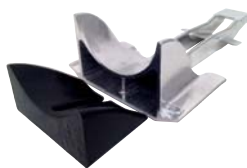

PUMP SEAL KIT FOR SPARK

Description	Part No.
R&D Sea-Doo Spark Pump Seal for OEM Scoop	163-81900
R&D Sea-Doo Spark Pump Seal for Aquavein (113-96001)	163-81901
RIVA Pump Seal Kit for RS22130	RS25130
WORX Pump Seal Kit for WR244	WR0707



RIVA SEA-DOO SPARK BACKING PLATE & BILGE UPGRADE KIT

- Allows intake grate to be removed & replaced without deck removal.
- Bulletproof mounting system reinforces the plastic hull for added strength.

- Improves efficiency of syphon bilge pump system.
- Improves effectiveness of hull drain plug

Applications: All Spark 2- and 3-seater models.

Description	Part No.
Spark Backing Plate & Bilge Upgrade Kit	RS21130-BPK-RI

123-80910



WR319

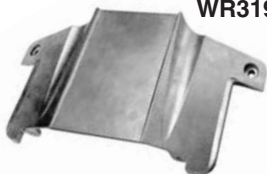

RIDE PLATE FOR SPARK

Description	Part No.
R&D Sea-Doo Spark Ride Plate	123-80910
WORX Sea-Doo Spark Ride Plate	WR319



ATLANTIS QUICK SNAP FLUSH KIT

Description	Part No.
Sea-Doo Spark Flush Kit	A7011



RIVA TRIM TAB KIT FOR SEA-DOO SPARK

- Reduced porpoising
- Improved high speed stability
- Quicker planning
- Increased top speed in choppy conditions
- Improved handling
- Allows use of factory boarding step

Description	Part No.
RIVA Sea-Doo Spark Trim Tab Kit	RS27130-FPT



RIVA SEA-DOO SPARK STEERING SYSTEM

- High strength aluminum construction delivers superior strength & rigidity
- Accepts all popular 7/8" handlebars
- Hollow steering column accommodates OEM wiring harness
- Billet aluminum steering arm features adjustable "quick turn" settings
- Retains "Off Throttle Assisted Steering" system
- Cutting-edge race styling
- All aluminum parts anodized to prevent corrosion

Description	Part No.
Sea-Doo Spark Steering System	RS20130

SEA-DOO SPARK • STEERING



WORX SEA-DOO SPARK STEERING SYSTEM

- Retains all OEM functions
- Improved ergonomics give you a more comfortable ride with less strain on your wrists
- Constructed from bulletproof aluminum for greater strength and durability over the OEM
- Allows you to use higher quality aftermarket 7/8" diameter handlebars



Description WORX Sea-Doo Spark Steering System
Includes throttle lever, start/stop switch holder, steering column, drive by wire actuator bracket and throttle cable.

Part No. WR06014



WORX SEA-DOO SPARK STEERING SYSTEM WITH ELECTRIC THROTTLE

Includes WORX all new billet anodized electronic throttle lever housing which utilizes OEM electronic throttle actuator up on the handle bars (no throttle cable required), start/stop switch holder, steering column and necessary hardware.

Description Sea-Doo Spark Steering System with Electric Throttle

Part No. WR06014-ET



WORX SEA-DOO SPARK STEERING SYSTEM WITH IBR

Includes WORX all new billet anodized throttle electronic actuator housing and IBR electronic actuator housing which utilizes OEM electronic actuators up on the handle bars (no throttle cables required), start/stop switch holder, steering column and necessary hardware. Retains all OEM functions including IBR (reverse).

Description Sea-Doo Spark Steering System with IBR

Part No. WR06014-IBR



RIVA SEA-DOO SPARK HANDLEBAR EXTENSIONS

Allows easy installation of popular ODI 130mm grips. Sold as a pair, grips sold separately. Fits Sea-Doo Spark.

Description Handlebar Extensions Spark

Part No. RS24130-BES

SEA-DOO SPARK • PUMP



Skat-Trak
140-75-30



Solas
SK-CD-12/17

SPARK IMPELLERS

Description	Part No.
Skat-Trak Sea-Doo Spark Impeller	SS407530SW1214
Solas Sea-Doo Spark Impeller	SK-CD-12/17



STAINLESS STEEL WEAR RING FOR SPARK

Replaces original plastic liner with easy installation. Durable, stainless steel resists debris damage and saltwater corrosion.

Description	Part No.
Solas Spark Wear Ring	SK-HS-140
RIVA Spark Wear Ring	RS33-140-SK
R&D Spark Wear Ring	133-50900
Skat-Trak Spark Wear Ring	REPAIRSDWR140
WSM Spark Wear Ring	003-510S



R&D ULTIMATE SPARK PUMP SEAL

Description	Part No.
R&D Pump Seal for Spark Wear Ring	163-81590



R&D ADJUSTABLE ANTI-CAVITATION SEA-DOO SPARK PUMP CONE

The R&D Billet Adjustable Pump Cone Kit is a creative new bolt on part that adds additional length over the OEM cone, and comes complete with tuning spacers. The extended length allows custom RPM tuning, reduced cavitation and adds additional pump thrust. Precision tuning the pump cones length with the kit included cone spacers will add to top speed while keeping the engine RPMs stable and out of the rev limiter.



Description	Part No.
Spark Adjustable Anti-cavitation pump cone	163-95900

SEA-DOO SPARK	INTAKE SYSTEMS	ENGINE/GASKETS	EXHAUST	DRIVE LINE HANDLING	ELECTRICAL	WATERLINE /BILGE	STEERING & CONTROLS	BODY	ACCESSORIES SERVICE TOOLS /HARDWARE	CHEMICAL
---------------	----------------	----------------	---------	---------------------	------------	------------------	---------------------	------	-------------------------------------	----------

SEA-DOO 4-STROKE • INTAKE

Sea-Doo Spark Parts & Accessories are now in the new Sea-Doo Spark feature section pages 6-9

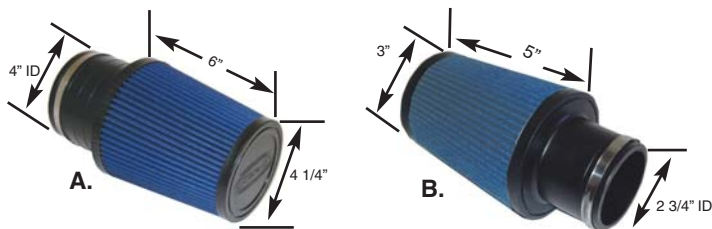

R&D POWER PLENUM FILTER KIT

The R&D filter kit will unleash restricted low-end, mid-range and peak horsepower trapped in the O.E.M. air filtration system and intake ducting by relieving the air intakes main restriction. The new R&D Filter Kit installs in place of the O.E.M. main air box plenums restrictive air intake cover.

Description	Part No.
A. RXP-X(255), RXT-X(255), RXP(215), RXT(185/215), GTX SuperCharged	203-00255
B. GTX 4-Tec N.A.(155)	203-95002



R&D COOL AIR VENT PLATE KIT

The R&D Kit allows two large 3" holes to be drilled into the plastic seat base mount. The R&D Kit supplies two Vent Plates that pop rivet securely in place that allows hot air to escape out while muffling sound. Rivets are not included.

Description	Part No.
RXP-X 260 (2012) Cool Air Vent Plate Kit	203-00270



R&D COOL 3" AIR FILTER KIT

The R&D Cool 3" Air Filter Kit is a system that utilizes the OEM intake hose.

Description	Part No.
RXP-X 260/GTR 215 (2012-14) Cool 3" Air Filter Kit	203-00260



RIVA RACING FLO-RITE AIR VENT

Flow-Rite™ Air Vents reduce underhood temperatures & improve performance by allowing hot air to escape engine compartment. These 2" water-repellent vents feature an integrated pre-filter that allows air to pass freely while keeping water out. Installs easily into engine cowling or deck of your watercraft.

Description	Part No.
RIVA Flo-Rite Air Vent (Sold individually)	RS-14-197



R&D PRO SERIES 4" AIR FILTER KIT

The R&D Kit includes a huge 4" "snap on" rubber velocity stack that allows the large 4" Kanaflex flexible hose to be attached to the supercharger and

cleanly run to the front of the hull to capture cooler air. The R&D Pro Series 4" Filter Kit has ZERO restriction to the supercharger through its oversized 5.5" x 8" filter, which results in quicker acceleration and more power.

Description	Part No.
RXP-X 260 (2012-14) Pro Series 4" Air Filter Kit	203-00264



RXP/RXT CATCH CAN/OIL BREATHER SYSTEM

Easy to install catch can/oil breather eliminates power-robbing crankcase fumes and oil vapor from your engine's air intake. Increases horsepower by removing the engine's requirement to burn relatively non-combustible oil. Also improves intercooler efficiency by preventing the oil sludge coating that lowers thermal efficiency. Excess oil vapor is routed to our translucent catch can where it condenses and collects for occasional draining via integrated petcock valve.

Description	Part No.
RIVA Catch Can Breather Kit, RXP 215, RXT 215, RXP-X 255, RXT-X 255, GTX 4-TEC, RXP-X 260 (T3) All RXT & GTX Non-Suspension Models (S3 Fixed Deck), Does Not Fit Suspension Deck 3 Models, RXP-X300, RXT-X300	RS19050-BCC-1



2015 IJSBA
QUAKYSENSE
WORLD FINALS IN
LAKE HAVASU CITY,
ARIZONA.

SEA-DOO 4-STROKE • INTAKE

Sea-Doo Spark Parts & Accessories are now in the new Sea-Doo Spark feature section pages 6-9

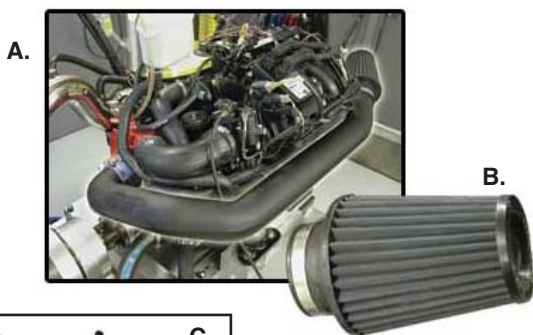

RIVA POWER FILTER KIT

Delivers greatly improved acceleration and a 1-2 mph (150-200 rpm) top speed increase by replacing the restrictive stock intake system. The Power Filter feeds your supercharger with a steady diet of cool air via a 3" diameter intake duct and oversized K&N filter element. Ducting is precision formed from a race proven composite that will not conduct heat to incoming air. Installs securely via a silicone coupler and sturdy bracket. Kit includes pre-filter element.

NOTE: It will be necessary to upgrade your stock pump impeller to a steeper pitch when using our Power Filter Kit. Sea-Doo and RIVA both strongly recommend the use of premium octane (91+) pump fuel in your Supercharged watercraft.

Description	Part No.
A. RIVA Power Filter Kit, RXP/RXT (2005-10), RXP-X 255 (2008-11)/RXT-X 255 (2008-10), GTX-SC (2005-09) Power Filter Kit GTX-SC (2003) only	RS13050-06 RS13050-03
B. Power Filter only for RS13050-03/06	RS13050-2
Pre-Filter Only for RS13050-2	RS13050-PF-BLK
C. Power Filter RXT iS&aS, GTX iS&aS	RS13100-S



INTAKE MANIFOLD UPGRADE KIT 255/260/300

RIVA's Intake Manifold Upgrade Kit enables your engine to produce more horsepower through increased boost pressure (+1lb). Supplied hole cutting tool allows easy removal of restrictive screen element from inside of intake manifold. Special O-ringed, billet block-off plug with integrated fitting for aftermarket boost pressure gauge fills opening left after removal of screen element. Includes detailed installation instructions. NOTE: RIVA's testing has determined the stock ECU will compensate for the increased boost provided by RIVA's Intake Manifold Upgrade Kit.

Description	Part No.
RXP-X/RXP-X 255/260	RS12080-IMUK
RXP-X300/RXT-X300	RS12040-IMUK



RIVA SEA-DOO POWER FILTER KIT

RIVA's Power Filter Kit draws cold air from outside your engine compartment delivering awesome performance and eliminating power-robbing heat intake. Forward air intake is separated from hot engine compartment with rigid thermal bulkhead that installs between engine & fuel tank. Cold air is delivered to engine via large 4" smooth-bore ducting that is attached to supercharger with unique velocity stack and sturdy billet clamps. Requires use of RIVA Catch Can/Oil Breather System (part# RS19050-BCC-1). IJSA legal for all classes.

Note: RXT-X 260 2011 & newer models require Tank Strap Upgrade Kit (part # RS13100-TSUK). Thermal bulkhead not included

Description	Part No.
RIVA RXT-X 260 (2010-11) (non iS/aS) Power Filter Kit	RS13100
RIVA RXP-X 260 (T3) 2012, GTR215 Power Filter Kit	RS13110



RIVA SEA-DOO RXP-X/RXT-X 300 POWER FILTER KIT

RIVA's new Sea-Doo 300 Power Filter feeds your supercharged engine a steady diet of cool air, delivering greatly improved acceleration and rpms. Replaces restrictive stock air box with a high-volume, precision-formed intake duct that attaches to the supercharger via a large 4" adapter. Cool air enters the system via an oversized K&N filter element. Simple installation & quick removal allow easy access for engine maintenance. Includes water-repellent pre-filter and detailed installation instructions.

Description	Part No.
RIVA RXP-X/RXT-X 300 & GTX LTD 300 (2016)	RS13140

RXP-X 260/RXP-X 300 COLD AIR UPGRADE KIT



- Thermal bulkhead isolates air intake from hot engine compartment.
- Provides inlets for stock air intake tubes.
- Extends intake to forward storage bin.
- Includes water baffles for ram air upgrade.
- Upgrade for RS13110 for RXP-X260 & RXP-X300 only.

Description	Part No.
Sea-Doo Cold Air Upgrade Kit RXP-X260, RXP-X300	RS13110-CAUK

SEA-DOO 4 STROKE	INTAKE SYSTEMS	ENGINE/GASKETS	EXHAUST	DRIVE LINE HANDLING	ELECTRICAL	WATERLINE /BILGE	STEERING & CONTROLS	BODY	ACCESSORIES	SERVICE TOOLS /HARDWARE	CHEMICAL
------------------	----------------	----------------	---------	---------------------	------------	------------------	---------------------	------	-------------	-------------------------	----------

SEA-DOO 4-STROKE • SUPERCHARGER

Sea-Doo Spark Parts & Accessories are now in the new Sea-Doo Spark feature section pages 6-9



RIVA GEN-2 SUPERCHARGER IMPELLER 215HP

Presenting the ultimate (drop-in) performance supercharger impeller for the Sea-Doo 215hp engine! Working closely with Vortech

Engineers, RIVA developed the next generation high-performance replacement impeller that delivers 9lbs of boost @ 8,100rpm in RIVA Stage II applications. Produces more horsepower and torque throughout the RPM range resulting in excellent acceleration & top speed. Investment cast from an extremely strong, lightweight proprietary aluminum and CNC machined to ensure exact tolerances. All new blade design is optimized aerodynamically and precision balanced to deliver smooth operation. Installs easily into stock supercharger housing with no additional modifications required. Includes replacement mounting nut and detailed installation instructions.

**Note: It will be necessary to upgrade your stock pump impeller to a steeper pitch when using the Gen-2 Supercharger Impeller. Sea-Doo and RIVA both strongly recommend the use of premium octane (91+) fuel in your Supercharged PWC.*

Description	Part No.
RIVA SC Impeller, all RXP 215/RXT 215/GTX-SC	RS1750-001B
RIVA Supercharger Impeller Nut	RS1750-001A-N

ET BILLET SUPERCHARGERS



ET 137X4MM CR DROP IN WHEEL FOR 255/260

ET Light Edition Billet Impeller with 4mm spacer. Aftermarket pressure

regulator (not included) is required for this modification. 48 Lbs injectors are required for this modification (not included). *Some Sea-Doo 255/260 models come with 48 Lbs injectors from the factory, please check your OEM specifications before installing this upgrade. 13 to 13.5Lbs of boost@8100rpm and 15Lbs boost@8500rpm (Clutch slip must be set to 15 Lbs)

Description	Part No.
15 Lbs Boost Supercharger	ET137X4MM CR
Billet Impeller with 4mm spacer	



RIVA SEA-DOO 255/260 XX2-CHARGER

RIVA's new XX2-Charger delivers 15 psi of boost pressure at 8,500rpm producing arm wrenching acceleration and increased top speed. High performance billet impeller & 4MM spacer increase horsepower through superior impeller blade design and larger interior housing volume. Lightweight billet impeller features a sophisticated blade design that is precision balanced to deliver smooth operation. Spacer & impeller install

quickly and easily onto stock supercharger base plate.

Applications: 255/260 Sea-Doo Models
• 13.5psi @ 8,100rpm • 15psi @ 8,500rpm

Description	Part No.
RIVA Sea-Doo 255/260 XX2-Charger	RS17080-SCI-XX2



ET68-140

Complete Sea-Doo Xtreme Supercharger by ET. 16-16.5Lbs @8600rpm and 18Lbs@9000rpm

Description	Part No.
ET68-140 Complete Supercharger	ET68-140

ET70-145RACE

Complete Sea-Doo Xtreme Supercharger by ET. This charger is capable of making up to 20Lbs of boost. This upgrade will require various upgrades: ECU, Injectors, Pressure Regulator and more depending on your engine configuration. This ET supercharger requires "RACE FUEL" and is intended for racing. 18Lbs @8600rpm and 20Lbs@9000rpm

Description	Part No.
ET70-145 Race Edition Charger	ET70-145RACE



R&D SUPERCHARGER SLEEVE

The sleeving up of the diameter of the Supercharger enables a 3.5" or 4" intake filter system to be utilized. The larger intake increases cubic air volume as well as decreases air inlet restriction. A win win, supercharge your supercharger and give it more air! Available in 3.5" and 4" diameters. Fits all Supercharged 4-Tec Models.

Description	Part No.
R&D Supercharger Sleeve 3-1/2" Diameter	613-95035
R&D Supercharger Sleeve 4" Diameter	613-95040



ET WATER COOLER FOR 255/260 WITH 4 POSTS

ET's new, innovative, fully Billet O-ringed water cooler cover. The back side of ET Water Cooler is CNC machined to the contour of the OEM housing using surfacing and features o-ring seals. Made from 6061-T6 Alum. and anodized red for corrosion resistance. Safely used with all OEM and ET Chargers, ET uses a 7mm spacer to ensure that the casting is thick and strong. It's easy to install on the OEM Front housing without any modifications. Comes with bolts, fittings and o-rings. Testing results were that housing temperature dropped by 45 degrees in a 20Lb setup. Less boost fade. Improve bearing and seal life also less under hood heat.

Description	Part No.
ET Water Cooler for Sea-Doo 255/260	ET-WC-COVER

SEA-DOO 4-STROKE • SUPERCHARGER

Sea-Doo Spark Parts & Accessories are now in the new Sea-Doo Spark feature section pages 6-9



Sea-Doo 260

R&D RXP/RXP-X/RXT/RXT-X GTX-SC SUPERCHARGER SURGE PROTECTOR KIT

The R&D Surge Protector Kit will significantly improve supercharger clutch and compressor wheel performance and reliability by eliminating compressor surge. Compressor surge is defined as the negative charge of pressure that causes turbulence in the supercharger that occurs during aggressive off-throttle operations. When the throttle valve is abruptly closed at high rpms, the engine decelerates quickly down from 8,000 rpms, however the supercharger is compressing air (creating boost) as the supercharger has to decelerate from 42,000 rpms. This turbulence is the primary cause of undue stress on the supercharger clutch system and its components. The R&D surge protection kit utilizes an automotive vacuum assisted Bosch pressure blow off valve that automatically releases the unwanted intake pressure between the closed throttle valve and the supercharger. As soon as the throttle valve is opened, the blow off valve immediately closes and the compressor can supply its full boost potentials to the engine.

Manufactured from high-temperature silicone hose with an integrated molded riser for the blow off valve to function without hindering intake flow or velocity. The R&D kit installs easily in place of the OEM rubber intake elbow joint. This kit is a very necessary and cost effective up-grade for all Sea-Doo supercharged watercraft. Kit comes completely assembled with silicone elbow, blow off valve, R&D B.O.V. filter, mounting hardware and instructions.

Description	Part No.
R&D RXP 215, RXT 215, GTX-SC SC, RXP-X 255, RXT-X 255, RXP-X 260, RXT-X 260, GTR 215 SC Surge Protector Kit	613-95258



RIVA TIAL 50MM BLOW-OFF VALVE

For use with RIVA Intercooler Tubing Upgrade Kit (RS17140-TK). Improves supercharger reliability and performance by relieving unwanted

pressure during off-throttle operation. Reduces supercharger clutch & gear wear and eliminates heat soak in discharge tube. The body and all internal components are CNC-machined from 6061 aluminum alloy. It features a large 1.98" (50.5mm) valve. The V-Band design aluminum mounting clamp gives a very clean and unique appearance. The clamp uses stainless steel hardware for a long lasting, corrosion-free appearance. The valve seal utilizes a Viton O-ring that is clamped in place for maximum durability. The valve stem and guide are Teflon-lubricated, hard anodize-coated for wear resistance. The blow-off valve also comes with our own machined aluminum banjo-type air fitting and bolt, with oversized 10mm hose barb for quick actuator response.

Description	Part No.
RXP-X300, RXT-X 300, GTX LTD 300	002573



RIVA SEA-DOO 215 SUPERCHARGER BLOW-OFF VALVE KIT FOR OEM ELBOW JOINT INSTALLATION

RIVA's Blow-off Valve Kit improves supercharger reliability and performance by relieving unwanted pressure during off-throttle operation. Reduces

supercharger clutch wear and eliminates heat soak in the discharge tube. High-strength silicone hose with integrated blow-off valve installs easily in place of OEM elbow joint. Includes K&N filter to prevent debris from entering valve outlet. A simple and cost effective upgrade for both stock and modified supercharged engines. Includes all necessary mounting hardware and installation instructions.

Description	Part No.
Blow-Off Valve Kit SD 215 RXP/RXT/GTX-SC	RS1750-BV



R&D MULTI-PRESSURE PORT BOOST GAUGE/SURGE/RRFPR ADAPTOR KIT

The R&D Sea-Doo Multi-Pressure Port Adaptor Kit will allow quick and easy "BOLT ON" installations of Rising Rate Fuel Pressure Regulators, Tial/Greddy type surge valves, as well as digital or manual boost/vacuum gauges. The R&D Multi-Pressure Port Adaptor installs smartly between the OEM Map Sensor and the Sea-Doo intake manifold as a "bolt on" part with no drilling modifications. The R&D adapter has two large volume ports that allow for proper installation and operation of a vacuum/boost gauge, surge protection valve, and boost referenced fuel pressure regulator (RRFPR) all at the same time with one simple part. The R&D Pressure Port Adaptor Kit comes complete with all mounting hardware and instructions.

Description	Part No.
R&D Multi-Pressure Port Boost Gauge/Surge/RRFPR Adaptor Kit	613-95270



2015 IJSBA QUAKYSENSE WORLD FINALS IN LAKE HAVASU CITY. PHOTO COURTESY OF JIN OMURA.

SEA-DOO 4 STROKE	INTAKE SYSTEMS	ENGINE/GASKETS	EXHAUST	DRIVE LINE HANDLING	ELECTRICAL	WATERLINE /BILGE	STEERING & CONTROLS	BODY	ACCESSORIES	SERVICE TOOLS /HARDWARE	CHEMICAL
------------------	----------------	----------------	---------	---------------------	------------	------------------	---------------------	------	-------------	-------------------------	----------

SEA-DOO 4-STROKE • SUPERCHARGER

Sea-Doo Spark Parts & Accessories are now in the new Sea-Doo Spark feature section pages 6-9

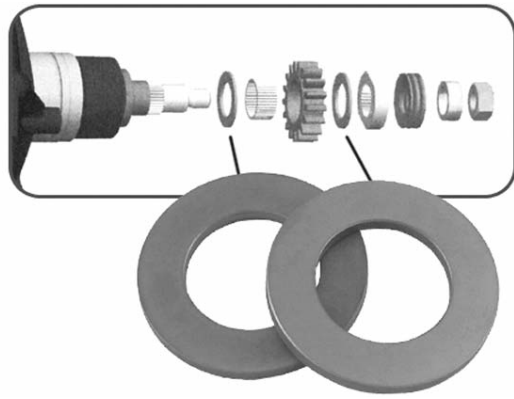

RIVA HEAVY-DUTY SUPERCHARGER CLUTCH WASHERS

These are direct replacements for the original clutch washers that are prone to fail on modified engines. Precision machined from tool grade steel to increase durability. Will not break up and damage engine at end of service life.

Description	Part No.
RIVA Clutch Washers (04-05) RXP, RXT, GTX SC	RS1751-HDW-945
RIVA Clutch Washers (06-07) RXP, RXT, GTX SC	RS1751-HDW-946*

*Note: RS1751-HDW-946 must be used with 2006 style Sea-Doo OEM Supercharger shaft Part #420881946

Description	Part No.
RIVA Clutch Washers (08 & Newer) 255HP RXP-X, RXT-X & 215HP RXP, RXT, GTX-SC, RXP-X 260, RXT-X 260	RS1751-HDW-948

NOTE: BRP recommends that you replace the Supercharger shaft/clutch assembly when servicing your supercharger.
Order part# 420881100 ('08 spec). Requires '08 spec Heavy-duty Clutch Washers (part# RS1751-HDW-948).

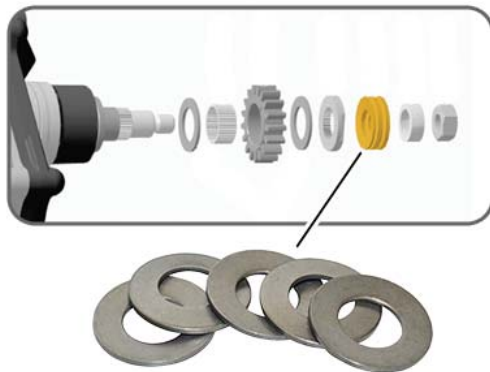

SD SUPERCHARGER SPRING WASHERS

Description	Part No.
RIVA Replacement Spring Washers (2008 & newer models). Sold in set of five.	RS17050-SWP-948

Description	Part No.
R&D SC Clutch Spring Replacement/ Upgrade Kit (Sold in set of five)*	613-95011

*A new high quality spring washer is .002" thicker than the OEM spring washer. This Kit will upgrade the slip torque tension of the OEM clutch by an added 2 lbs. over stock.



R&D SUPERCHARGER HIGH PERFORMANCE CLUTCH WASHER KIT

The R&D Superclutch Washer Kit was designed to improve reliability without disintegrating under the Sea-Doo superchargers high rpms, heat and is designed to not only but also increase boost by decreasing clutch slippage.

Description	Part No.
R&D Clutch Washer Kit (06-07) RXP/RXT 215*	613-95001
<i>*NOTE: (or any supercharger rebuilt or warranted with a BRP rebuild kit part #420881946 or #420881947) NOTE: BRP#420881946 is for 215 engines, and #420881947 is for 185 engines.</i>	
R&D Clutch Washer Kit (03-04) GTX 185 S/C, (04-05) RXP 215, (05) RXT 215	613-95002
<i>NOTE: BRP supercharger rebuilt kit installed, upgraded, or warranty updated with the BRP rebuild kits #420881947 (for 185) or #420881946 (for 215), these upgraded superchargers will require R&D PART # 613-95001</i>	
R&D Bronze Alloy Recreational Clutch Washer Kit (08) RXP/RXT 215HP, RXP-X/RXT-X 255HP/260HP	613-95006
R&D Racing Steel Washer Kit (08 & Newer) RXP/RXT 215HP, RXP-X/RXT-X 255HP/260HP	613-95007



R&D REPLACEMENT SUPERCHARGER CLUTCH GEAR

The R&D 16 Tooth Clutch Gear is a direct replacement for worn or broken OEM clutch gears. Manufactured from billet steel alloy, CNC machined, heat treated, and precision ground to final specification.

Description	Part No.
Sea-Doo (2004-13) 215/255/260 HP Supercharger 16 Tooth Replacement Clutch Gear	613-95016



2015 HOT PRODUCTS IJSBA MARK HAHN MEMORIAL HAVASU 300 ENDURANCE RACE IN LAKE HAVASU CITY, ARIZONA.

SEA-DOO 4-STROKE • SUPERCHARGER & TOOLS

Sea-Doo Spark Parts & Accessories are now in the new Sea-Doo Spark feature section pages 6-9



WSM SUPERCHARGER REBUILD KIT



010-102K



010-103K

Description	Part No.
WSM Sea-Doo Supercharger Rebuild Kit OEM#420881101/420881102 16 tooth gear	010-102K
WSM Sea-Doo Supercharger Rebuild Kit OEM#420881151 17 tooth gear non-intercooled	010-103K



R&D SUPERCHARGER REBUILD TOOLS

R&D has designed custom tools that are essential in the rebuilding process of a Sea-Doo Supercharger. All tools are specific in application and are CNC machined to ensure a precision job.

Description	Part No.
A. Supercharger Holder Tool	613-96005
B. Bearing Puller/Installer Tool	613-96006
C. Seal/Bearing Retainer Torx Wrench	613-96008
D. 215HP 16 Tooth Drive Gear Tool	613-96016
D. 185HP 17 Tooth Drive Gear Tool	613-96017
E. 185/215/255/260HP Clutch drive / Lock Washer Tool	613-96019

SEA-DOO OEM TYPE SPECIALTY TOOLS

For the removal, repair and installation of Sea-Doo Superchargers.



Super Charger Retaining Key
Part No. 950-110
O.E. No. 529-035-949
All 4 Tec's with Super Chargers



4-Pin Socket
Part No. 950-195
O.E. No. 529-035-948
Fits: 4-Tec Supercharged



Torx Adapter For All Super Charged 4-Tecs
Part No. 950-185
O.E. No. 529-035-938
Fits: 4-Tec Supercharged



Support Plate 4-TEC Supercharged Engines
Part No. 950-190
O.E. No. 529-035-947
Fits: 4-Tec Supercharged



Ball Bearing Support Pusher
Part No. 950-200
O.E. No. 529-035-950
Fits: 4-Tec Supercharged



Camshaft Locking tool
Part No. 950-180
O.E. No. 529-035-839
Fits: 4-Tec Engines

See page 319 for additional WSM tools.



RIVA SEA-DOO SUPERCHARGER SHAFT HOLDER TOOL

Servicing your supercharger in a snap. Ergonomically designed billet handle, heat treated tool-grade steel to resist wear and to prevent flexing.

Description	Part No.
RIVA Sea-Doo Supercharger Shaft Holder Tool	RS1750-ISH-949

SEA-DOO
4 STROKE

INTAKE
SYSTEMS

ENGINE/
GASKETS

EXHAUST

DRIVE LINE
HANDLING

ELECTRICAL

WATERLINE
/BILGE

STEERING
& CONTROLS

BODY

ACCESSORIES

SERVICE TOOLS
/HARDWARE

CHEMICAL

SEA-DOO 4-STROKE • INTERCOOLER

Sea-Doo Spark Parts & Accessories are now in the new Sea-Doo Spark feature section pages 6-9



RIVA SEA-DOO RXP-X 300/RXT-X 300 GEN 4 POWER COOLER

RIVA's "GEN-4" Power Cooler is the ultimate intercooler for the new Sea-Doo 300 engine! Huge cooler core delivers excellent thermal efficiency and minimal pressure drops. Perfect for use in high boost supercharged and turbo applications. Precision machined billet water tanks hold up to high pressure cooling systems that can cause original coolers to fail. This is a direct high performance replacement for all Sea-Doo 300 applications.

- Cooler & denser air charge produces more horsepower
- Huge cooler element rated for 600hp
- Replaceable sacrificial zinc anode protects cooler element from corrosion
- Integrated flushing system keeps power cooler at peak performance

Description	Part No.
Sea-Doo RXP-X 300/RXT-X 300 Gen 4 Power Cooler	RS1753-PC-1

RIVA SEA-DOO 'GEN-3' POWER COOLER CORE

Requires use of RXP-X/RXT-X 260 intercooler tubing upgrade kit (RS17090-TK).

Key Features Include:

- Cooler & denser air charge produces more horsepower.
- Large cooler element rated for 450HP.
- Replaceable sacrificial zinc anode protects cooler element from corrosion.
- Integrated flushing system keeps Power Cooler at peak performance.

APPLICATIONS:

- Direct replacement for smaller OEM 2011-12 external intercoolers.
- Direct replacement for all OEM 2010 and prior external intercoolers.
- Compatible upgrade for RIVA 'GEN-2' Power Cooler Kit (RS1751-PC).

Description	Part No.
RIVA SD 'Gen-3' Power Cooler Core 215/255/260 iControl, 255 non-iControl	RS1752-PC-I



RIVA SEA-DOO RXP-X 300/RXT-X 300 OEM INTERCOOLER TUBING UPGRADE KIT

RIVA's Intercooler Tubing Upgrade Kit significantly improves the performance & reliability of your intercooler system. This is an essential upgrade for all racing and recreational performance craft.

- Precision formed aluminum tubing: RIVA's high strength aluminum tubes are shorter than original to minimize boost loss. Rigid aluminum will not swell under pressure like original soft rubber hoses providing improved throttle response & reliability
- Tubing includes mount for TIAL 50mm Blow-Off Valve (002573) or RIVA Blow-Off Valve Block-Off Kit (RS1753-BVBO); both sold separately. Use of blow-off valve reduces wear and tear on clutch & drive gears of supercharger and eliminates heat soak in discharge tube.
- High quality silicone couplers & stainless steel clamps included.

Description	Part No.
Sea-Doo RXP-X 300/RXT-X 300 OEM Intercooler Tubing Upgrade Kit	RS17140-TK



RIVA SEA-DOO RXP-X/RXT-X 260 INTERCOOLER TUBING UPGRADE KIT

Key features include:

- **Precision formed aluminum tubing:** High strength aluminum tubes are shorter than original to minimize boost loss. Rigid aluminum will not swell under pressure like original soft rubber hoses providing improved throttle response & reliability.
- **Integrated blow-off valve mount:** Intercooler tubing includes mount for HKS Blow-Off Valve Kit (RS17081-BOV-SSQV) or RIVA Blow-Off Valve Block-off Kit (RS1750-BVBO); both sold separately. Use of blow-off valve reduces wear and tear on clutch & drive gears of supercharger and eliminates heat soak in discharge tube.
- High quality silicone couplers & stainless steel clamps.
- GTR 215 models require RIVA Power Coller Installation Kit (part# RS1752-PCIK-GTR).

Fits all 09-12 Sea-Doo craft with S3 hulls (RXT/GTX S3 models) along with 2012 RXP-X 260 T3 hull. Requires use of RIVA 'GEN-3' Power Cooler (part# RS1752-PC-I) or OEM 2008-10 Sea-Doo 255/260 intercooler. Not compatible with smaller 2011 and newer OEM intercoolers.

Description	Part No.
RIVA RXP-X 260, RXT-X 260, GTR215 Intercooler Tubing Upgrade Kit (S3 & T3 Hull)	RS17090-TK

SEA-DOO 4-STROKE • INTERCOOLER

Sea-Doo Spark Parts & Accessories are now in the new Sea-Doo Spark feature section pages 6-9



RIVA OEM INTERCOOLER UPGRADE KIT 255HP

Key benefits include:

- Relocation of original intercooler: By strategically moving original intercooler, This upgrade greatly improves access to engine compartment. Relocation also allows installation of key performance parts including RIVA Rear Exhaust Kit (RS15050-1) & RIVA Pro-Series Power Filter Kit (RS13050-06).
- Precision formed aluminum tubing: The high strength aluminum tubes are shorter than original to minimize boost loss. Also, the rigid aluminum will not swell under pressure like original soft rubber hoses providing improved throttle response.
- Integrated blow-off valve mount: Intercooler tubing includes mount for RIVA Pro-Series Blow-Off Valve Kit (RS17081-BOV-SSQV) or RIVA Blow-Off Valve Block-off Kit (RS17050-BVBO); both sold separately. Kit includes sturdy aluminum intercooler mounting bracket, high strength mandrel bent aluminum tubing and all necessary mounting hardware & installation instructions. Requires installation of RIVA Rear Exhaust Kit (RS15050-1) and RIVA Performance OPAS Block-off Kit (RS29050-1).

Description	Part No.
RIVA RXP-X 255 (2008-11),	RS17080-ICUK
RXT-X 255 (2008-10) Stock Intercooler Upgrade Kit	

WSM OIL PUMP REPAIR KIT

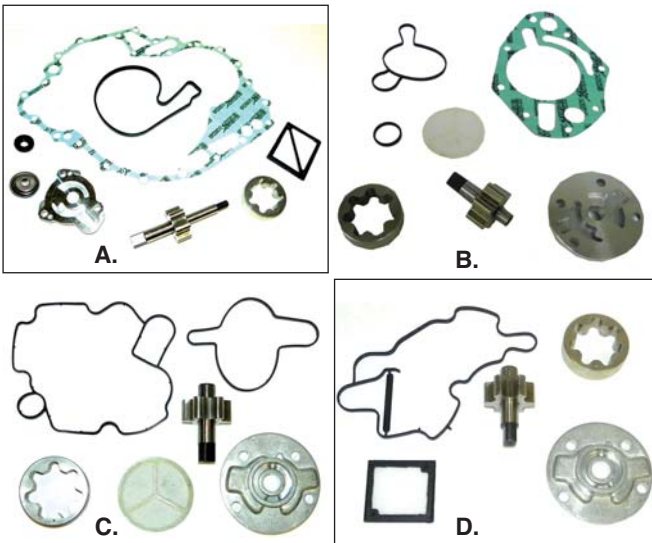

Primary Oil Pump Repair Kit (Rear)	Part No.
A. Sea-Doo 4-Tec All (2002-13)	010-1200
Secondary Oil Pump Repair Kit	Part No.
B. Sea-Doo All 4-Stroke (2002-12) (Except RXP)	010-1205
Secondary Oil Pump Repair Kit (Front)	Part No.
C. Sea-Doo RXP (2005)	010-1210
D. Sea-Doo All 4-Stroke (2006-12)	010-1215



WORX SEA-DOO PERFORMANCE EXTERNAL INTERCOOLER

Worx Racing's NEW Performance Sea-Doo 4-tec Intercooler provides huge gains over OEM intercooler, providing a cooler, denser air to the engine, increasing horsepower! The 30% larger, wider core allows for better heat transfer of compressed air from supercharger or turbo charger before entering engine. Worx Racing's NEW Sea-Doo Intercooler is a direct replacement of all Sea-Doo 4-tec external intercoolers and is suitable for all applications from stock to open turbo watercraft. Unit comes with necessary water fittings to suit OEM cooling applications, pressure bleed on front of unit and a replaceable sacrificial anode to extend intercooler life.

Description	Part No.
WORX 4-tec Intercooler	NEW WR04040

SEA-DOO INTERCOOLER/SUPERCHARGER LUBRICATION KIT

This kit will allow you to spray a aerosol lubricant of your choice into the supercharger, intercooler and throttle body to prevent rust from the excess moisture in the system. Complete instructions, pictures and a diagram supplied for a simple installation.

Description	Part No.
E. Sea-Doo Spray Nozzle Inlet for Lubrication	IWCS-SSU
F. Replacement Plug for Nozzle Inlet Kit	IWCS-SU-P

TORX® SOCKET SET FOR SEA-DOO ENGINES

Special Star Sockets for Sea-Doo 4-TEC & DI engine bolts are made from heat-treated vanadium steel and black oxide coated for durability. Supplied in a convenient vinyl socket holder.

- Four 3/8" Drive Sockets (T10, T12, T14, T16)
- Three 1/4" Drive Sockets (T6, T7, T8)

Description	Part No.
Torx Socket Set	LS26750

TORX® BIT SET FOR SEA-DOO ENGINES

Seven 1/4" Hex Insert Bits with 1/4" Drive Bit Holder. T-10 through T-40.

Description	Part No.
Torx Bit Set	NEW LS26000

SEA-DOO 4 STROKE	INTAKE SYSTEMS	ENGINE/GASKETS	EXHAUST	DRIVE LINE HANDLING	ELECTRICAL	WATERLINE /BILGE	STEERING & CONTROLS	BODY	ACCESSORIES	SERVICE TOOLS /HARDWARE	CHEMICAL
------------------	----------------	----------------	---------	---------------------	------------	------------------	---------------------	------	-------------	-------------------------	----------

SEA-DOO 4-STROKE • INTERCOOLER • THERMOSTAT

Sea-Doo Spark Parts & Accessories are now in the new Sea-Doo Spark feature section pages 6-9

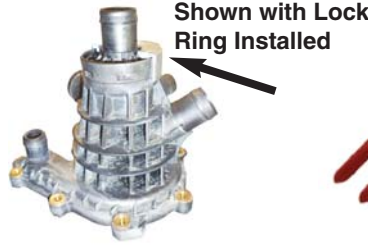

R&D ENGINE THERMOSTAT & INTERCOOLER COOLING KIT

The R&D Thermostat/Intercooler/Engine Cooling Kit is one stop shopping to solve several big issues with the O.E.M. cooling system. Engine temperatures on a RXP 260 engine with performance upgrades can reach 190-195 degrees with the stock cooling system. The R&D Kit changes out the stock thermostat for a new cooler 160 degree thermostat. The R&D Kit also separates and re-routes the "intercooler out" and "engine out" water lines to allow less restriction and more water to flow through both the engines exhaust system and the intercooler which will promote cooler exhaust temperatures as well as reduce intake air temperatures. The R&D Kit also includes two new 1/2 inch water bypass fittings for the intercooler in and out lines, one to be used with the kit included high pressure relief valve, and one for the new intercooler water out line. The R&D "high pressure" relief valve will protect the intercooler from being broken due to high water pressure spikes. Cooler engine temperatures, cooler intake air temperatures, and cooler exhaust temperatures all add up to a noticeable RPM and top speed gain.

Description R&D Thermostat & Intercooler Cooling Kit **Part No.** 663-15000



R&D ENGINE THERMOSTAT KIT

The R&D Engine Thermostat Kit is designed to lower the engine operating temperature. Engine temperatures on a Sea-Doo 260 engine with performance upgrades can reach 190-195 degrees with the stock cooling system. The R&D Kit changes out the stock thermostat for a new cooler 160 degree thermostat. Cooler engine temperature adds up to a noticeable RPM and top speed gain. Kit comes complete with installation tool.

Description R&D Engine Thermostat Kit **Part No.** 663-15010

RIVA SEA-DOO BVIC INTAKE BLOCK-OFF



Made from billet aluminum, RIVA's block-off plate fills the opening in the 215 intake manifold left when the stock intercooler is removed. Integrated fitting allows for use of aftermarket boost gauge. Includes Viton o-ring and is anodized to prevent corrosion.

Description RIVA BVIC Intake Block-off **Part No.** RS1750-PC-ABBO

RIVA RXP/RXT/GTX THERMOSTAT KIT

RIVA's cool running Thermostat Kit reduces the operating temperature of your modified 4-Tec® engine by 30°F for maximum reliability and performance. Kit includes replacement thermostat, billet coolant inlet flange, stock thermostat removal tool, Oetiker® clamps, Oetiker® pliers and detailed installation instructions. *NOTE: Thermostat housing (shown above) not included.

Description RIVA Thermostat Kit, SD RXP/RXT/GTX **Part No.** RS1015

SEA-DOO MODEL-HULL REFERENCE CHART

Model	Year	SC or NA	Hull	Notes
GTI 130	2006-2010	NA	GTI-1	Version 1 of 4-TEC GTI hull
GTI 130	2011-2016	NA	GTI-2	Version 2 of 4-TEC GTI hull.
GTI LTD 155	2011-2016	NA	GTI-2	Version 2 of 4-TEC GTI hull.
GTI SE 155	2007-2010	NA	GTI-1	Version 1 of 4-TEC GTI hull
GTI SE 155	2011-2016	NA	GTI-2	Version 2 of 4-TEC GTI hull.
GTI SE 130	2006-2010	NA	GTI-1	Version 1 of 4-TEC GTI hull
GTI SE 130	2011-2016	NA	GTI-2	Version 2 of 4-TEC GTI hull.
GTR 215	2012-2016	SC	GTI-2	Version 2 of 4-TEC GTI hull. Super-charged 215hp 1503 engine.
GTS 130	2011-2016	NA	GTI-2	Version 2 of 4-TEC GTI hull.
GTX 155	2005-2009	NA	GTX-1	Original 4-TEC GTX hull.
GTX 155	2010-2016	NA	S3	S3 with iBR.
GTX 4 TEC	2002-2004	NA	GTX-1	Original 4-TEC GTX hull.
GTX 4-TEC SC	2003-2004	SC	GTX-1	Original 4-TEC GTX hull.
GTX 4-TEC TOW	2003-2004	NA	GTX-1	Original 4-TEC GTX hull.
GTX SC 215	2005-2006	SC	GTX-1	Original 4-TEC GTX hull.
GTX 215	2008-2009	SC	GTX-1	Original 4-TEC GTX hull.
GTX 215	2011-2012	SC	S3	S3 with iBR.
GTX IS 215	2010-2011	SC	S3	S3 with iBR.
GTX 215	2012-2013	SC	S3	S3 with iBR.
GTX LTD 215	2014-2016	SC	S3	S3 with iBR (fixed deck).
GTX 255	2004	SC	GTX-1	Original 4-TEC GTX hull.
GTX LTD 215	2005-2008	SC	GTX-1	Original 4-TEC GTX hull.
GTX IS 255	2009	SC	S3	S3 with iBR.
GTX LTD IS 260	2010-2016	SC	S3	S3 with iBR.
GTX LTD 300	2016	SC	S3	S3 with iBR.
GTX S 155	2012-2016	NA	S3	S3 with iBR.
RXP 155	2007-2008	SC	RXP-1	Original RXP hull with short intake duct.
RXP 215	2004-2009	SC	RXP-1	Original RXP hull with short intake duct.
RXP-X 255	2008-2011	SC	RXP-2	Original RXP hull with longer intake duct.
RXP-X 260	2012-2015	SC	RXP-3	All new 260HP, T3 and iBR.
RXP-X 300	2016	SC	RXP-3	300HP, T3 and iBR
RXT 215	2005-2010	SC	GTX-1	Original 4-TEC GTX hull.
RXT-X 255	2008-2009	SC	GTX-1	S3 with iBR.
RXT IS 255	2009	SC	S3	S3 with iBR.
RXT IS 260	2010-2012	SC	S3	S3 with iBR.
RXT 260	2011-2016	SC	S3	S3 with iBR.
RXT-X aS 260	2011	SC	S3	S3 with iBR.
RXT-X aS 260	2012-2016	SC	S3	S3 with iBR, bow stabilizers, adjustable rear sponsons & adjustable trim tabs.
RXT-X 260	2010-2015	SC	S3	S3 with iBR.
RXT-X 300	2016	SC	S3	300HP, S3 with iBR.
WAKE 155	2005-2009	NA	GTX-1	Original 4-TEC GTX hull.
WAKE 155	2010	NA	GTI-1	Version 1 of 4-TEC GTI hull.
WAKE 155	2011-2016	NA	GTI-2	Version 2 of 4-TEC GTI hull.
WAKE 215	2007-2009	SC	GTX-1	Original 4-TEC GTX hull.
WAKE 215	2010-2016	SC	S3	S3 with iBR.
Spark 900	2014-2016	NA	Spark	
Spark 900 H.O.	2014-2016	NA	Spark	

*SC = Supercharged, N/A = Naturally Aspirated

iBR = Intelligent Brake & Reverse. It's the system at the rear of the craft that works the brake bucket, reverse bucket and variable trim system.

Sea-Doo reference chart courtesy of RIVA RACING

SEA-DOO 4-STROKE • EXHAUST

Sea-Doo Spark Parts & Accessories are now in the new Sea-Doo Spark feature section pages 6-9



RIVA WATER BOX RXP-X 300/RXT-X 300

Our Pro-Series Sea-Doo Water Boxes deliver increased horsepower and performance by reducing exhaust restriction and back pressure. Developed on a flow bench, our water boxes feature radiused exhaust tubes and end caps for optimum exhaust flow. Innovative short design allows easy servicing of super-charger without removal of exhaust system. High strength aluminum construction & precision welds will survive backfires & overheating. Powder coated to prevent corrosion. Includes detailed installation instructions.

Description	Part No.
Application RXP-X/RXT-X 300, GTX LTD 300	RS16141



RIVA PRO SERIES SEA-DOO S3/T3 WATER BOX

Applications: 2012 & Newer Sea-Doo RXP-X (T3) Models
2009 & Newer Sea-Doo RXT/GTX iControl (S3) Models

Important: The following additional RIVA Exhaust Components are required to complete the installation.

- RXT/GTX (S3) iControl Models:
Aluminum Exhaust Tube RS16091-ET-100
- RXP-X (T3) iControl Models:
Aluminum Exhaust Tube RS16091-ET-110
- All S3 & T3 Models:
Billet Rear Exhaust Outlet RS15090-ET

Note: Water Box is not designed or intended to be used with stock rubber exhaust hose and/or stock exhaust outlet.

Note: RS15090-RSB is required for iS/aS SE models. Not required for RXP-X 260 (T3) as there are no storage compartments at rear of craft.

Description	Part No.
RIVA Sea-Doo S3/T3, GTR 215 Models Water Box	RS16091
RIVA Rear Storage Bucket	RS15090-RSB



RIVA REAR EXHAUST STOCK OUTLET COUPLER KIT

Used when installing RIVA Pro Series Aluminum Water Boxes in Sea-Doo RXP-X, RXT-X, RXP, RXT & GTX-SC models that have the stock exhaust outlet in place. High temperature silicone coupler and stainless steel hose clamps connect water box outlet tube with thru-hull outlet flange.

Description	Part No.
RIVA Rear Exhaust Outlet Coupler Stock Kit	RS16082-ECK



RIVA REAR EXHAUST OUTLET KIT FOR AFTERMARKET INTERCOOLER OR WATERBOX

Kit allows you to relocate exhaust outlet to rear of craft when using aftermarket intercooler systems or water boxes. Includes billet through-hull exhaust outlet and OE exhaust outlet block-off along with all necessary mounting hardware.

Description	Part No.
RIVA Rear Exhaust Outlet Kit SD 215/255 Models	RS15050-ET
RIVA Rear Exhaust Outlet Kit SD RXT/GTX (S3) and RXP-X (T3) iControl Models*	RS15090-ET

**S3, T3 Models, Please Check Hull List page 18*



R&D SEA-DOO 215/250/260 EXHAUST MANIFOLD X-TENDER / O2 SENSOR MOUNT KIT

The R&D Exhaust X-Tender Kit allows the exhaust to be extended 2 inches which will move the water muffler back 2 inches creating enough room to be able to change out a super-charger (Hot) in 5 minutes. No more hassling with extremely hot exhaust pipes, water mufflers and V-band clamps! An additional bonus is the oxygen sensor mount incorporated into the X-Tender, allowing quick and easy installation of an AFR Gauge (Air/Fuel Ratio) for properly tuning the X power plant. The X-Tender kit installs easily using an additional OEM V-band clamp. The R&D kit will install directly to all Sea-Doo X supercharged models using O.E.M. BRP hardware. You will need to purchase an extra OEM V band clamp. One is not provided.

Description	Part No.
R&D Exhaust Manifold	333-80155
X-Tender/O2 Sensor Mount Kit for Sea-Doo 215/250/260	
R&D Manifold Exh X Tender Kit RXP, RXT 215HP	613-95004



R&D BILLET EXHAUST OUTLET

Description	Part No.
R&D 3" Diameter R&D Billet Exhaust Outlet	331-30000
R&D 2.75" Diameter R&D Billet Exhaust Outlet	331-32750

SEA-DOO 4 STROKE	INTAKE SYSTEMS	ENGINE/GASKETS	EXHAUST	DRIVE LINE HANDLING	ELECTRICAL	WATERLINE /BILGE	STEERING & CONTROLS	BODY	ACCESSORIES	SERVICE TOOLS /HARDWARE	CHEMICAL
------------------	----------------	----------------	---------	---------------------	------------	------------------	---------------------	------	-------------	-------------------------	----------

SEA-DOO 4-STROKE • EXHAUST

Sea-Doo Spark Parts & Accessories are now in the new Sea-Doo Spark feature section pages 6-9



RIVA EXHAUST TUBE FOR RS16091 WATER BOX

Mandrel bent aluminum exhaust tube with bead rolled end couples our Pro Series Water Box (part # RS16091) with our Billet Rear Exhaust Outlet (part # RS 15090-ET). Powder coated to prevent corrosion.

Description	Part No.
For use in 2009 & Newer Sea-Doo RXT/GTX (S3) iControl Models	RS16091-ET-100
For use in 2012 & Newer Sea-Doo RXP-X (T3) GTR 215 Models	RS16091-ET-110



RIVA FREE FLOW EXHAUST KITS FOR OEM INTERCOOLER AND OEM WATER BOX UTILIZING STOCK SIDE EXHAUST OUTLET

Replaces the restrictive sound suppression system located between the water box and hull exit on your watercraft. Improves engine performance by reducing back pressure and harmful detonation. Includes mandrel bent aluminum tubing that is powder coated to prevent corrosion, high-temp silicone replacement coupler and installation instructions.

Description	Part No.
RXP-X 300, RXT-X 300, GTX LTD 300	RS16140
All S3 & T3 Hulls including RXT-X 260, iS & aS units, RXP-X260	RS16090
RXP-X 255, RXT-X 255 (08-11) "Non iControl"	RS16080

RIVA REAR EXHAUST KITS FOR OEM INTERCOOLER AND OEM WATER BOX UTILIZING STRAIGHT EXHAUST OUTLET



RIVA's rear exhaust kit delivers performance and cutting-edge style. Allows for removal of restrictive sound suppression system located between water box and hull exit. Improves engine performance by reducing back pressure and restriction. Includes mandrel bent aluminum exhaust tube that is powder coated to prevent corrosion, large billet through-hull exhaust outlet, billet OEM exhaust outlet block-off and high-temp silicone couplers along with all necessary mounting hardware & installation instructions.

Description	Part No.
RXP-X 300	RS15150
RXT-X 300, GTX LTD 300	RS15140



- 2008-2011 RXP-X 255 non-iControl
- 2004-2009 RXP 215
- 2008-2009 RXT-X non iControl
- 2003-2010 RXT/GTX 215 non-iControl

Note: Removal of O.P.A.S. and installation of RIVA Performance O.P.A.S. Block-off Kit is necessary

to accommodate installation of RIVA Rear Exhaust Kit for all models. RXP-X & RXT-X models require use of OEM Intercooler Upgrade Kit, along with O.P.A.S. Block-off Kit.

Description	Part No.
255/215hp (non iControl)	RS15050-1



- Fits all RXT-X/RXT (S3) fixed deck models with no other modifications.
- RXT/GTX iS & aS (S3) suspension models require additional RIVA Rear Storage Bucket (part # RS15090-RSB)

Description	Part No.
Sea-Doo S3 Models	RS15100-2
Storage Bucket for iS/aS Models	RS15090-RSB



- Fits 2012 & Newer Sea-Doo RXP-X 260

Description	Part No.
RXP-X 260 (T3) (2012-15)	RS15110-1
RIVA Rear Exhaust Kit GTR 215 (2012-15)	

SEA-DOO 4-STROKE • ECU • SPEED OVERRIDE

Sea-Doo Spark Parts & Accessories are now in the new Sea-Doo Spark feature section pages 6-9



RIVA/VI-PEC V88R3 PRO SERIES ECU

The RIVA/Vi-Pec V88R Pro Series ECU provides a huge performance advantage to Sea-Doo iControl models delivering over 40hp to the stock 4-TEC engine. ECU is fully programmable with either RIVA supplied mapping or user defined parameters. Most calibrations require use of RIVA Fuel Pressure Regulator Kit and 91+ octane pump fuel. Plugs directly into factory wiring harness via waterproof connectors.

Key Features Include:

- 1) Easy loading of supplied calibrations/maps for various performance applications.
 - Performance Fuel Mapping
 - Performance Timing Curves
 - Rev Limiter Increase
 - Boost Control for turbo applications. (Plug & play connector for wastegate solenoid).
- 2) Ability to customize RIVA calibrations for special applications. Using supplied software, user can adjust parameters such as Fuel, Timing, Rev Limiter & Boost Control.
- 3) Retains all iControl functions.
- 4) Retains all OEM dash display functions & Engine Safety Functions.
- 5) Internal Data logging functionality.
- 6) Provides diagnostic information that can be displayed via computer interface.
- 7) Includes plug & play connector for RIVA Dash/Logger unit (RY11840-LD-MD60)
- 8) Includes plug & play connector for optional Lambda sensor kit (part# RY11540-LC1-6S5) for data logging air/fuel ratios & tuning functions.
- 9) Direct-Connect design eliminates need for auxiliary wiring harness.
- 10) Individual Cylinder Knock Control function. Identifies which cylinder is detonating by tracking firing order utilizing OEM knock sensor.
- 11) User selectable dual calibration capacity for optional Dual Map Switch (part # RY11841-DMS-ECU-PC).
- 12) Expansion Port for additional user definable inputs & outputs.
- 13) User configurable software.

NOTE: RIVA Pro-Series ECU is for competition use only.

Description	Part No.
RIVA Vi-Pec V88R ECU	RS11890-ECU-DC-1
Sea-Doo 2012 & Newer Models, RXP-X/RXT-X 260/300	



RIVA SEA-DOO SPEED CONTROL OVERRIDE MODULE

The RIVA Speed Control Override Module removes the restrictive GPS speed control function on Sea-Doo iControl models delivering significant increases in top speed with stock ECU. Easy to install module allows system to start in "Sport Mode" for maximum performance. "Touring Mode" can be manually selected after start up.

Key Features:

- Removes GPS controlled speed limiter.
- Increases top speed utilizing stock ECU.
- Works on all 2010 & newer iControl models.
- U.S. models will gain 3mph with aftermarket pump impeller.
- **2012 RXP-X 260 models:** Stock Pump Impeller
- **All 2011-12 RXT & GTX 260 models:** SRX-CD-15/20R
- **All 2010 RXT & GTX 260 models:** SRX-CD-15/22R
- Allows further top speed gains through aftermarket modifications.
- Allows system to start in "Sport Mode".
- All original dash functions are retained.
- Easy plug-in installation.

NOTE: Stock ECU limits peak RPM for first 5 hours of operation. Top speed increases should be measured after 5 hour break in period.

Description	Part No.
2010 Sea-Doo	RS11090-SCOM-10
2011-15 Sea-Doo RXP-X/RXT-X 260/300	RS11090-SCOM-11
2016 Sea-Doo 260/300	RS11090-SCOM-16



R&D SEA-DOO SPEED CONTROL OVERRIDE MODULE

The R&D Boost Box for 2011-2014 Sea-Doo 260 offers a plug and play way to quickly and easily disconnect the engine management systems internal GPS speed limiter to allow an incredible five mile per hour top speed gain!

The R&D Boost Box allows maximum boost pressure (10 PSI) to be reached by overriding the O.E.M. internal GPS speed control. With 3 pounds of boost pressure over stock settings this will allow the Sea-Doo 260 engine to accelerate better and pull harder in the upper mid range and top end with up to 5 mph speed gain.

The R&D Boost Box is a vital and necessary key to unlocking and adding performance to the new Sea-Doo 260 engine platform. Whether you are a recreational enthusiasts or an offshore racers who is interested in more performance, the Boost Box is an absolute "Must Doo" Upgrade. The R&D Boost Box installs easily in 5 minutes. Also fits on GTR 215 (2012-13).

Description	Part No.
2011-14 Sea-Doo Boost Box/SCOM	803-01001

SEA-DOO 4 STROKE	INTAKE SYSTEMS	ENGINE/ GASKETS	EXHAUST	DRIVE LINE HANDLING	ELECTRICAL	WATERLINE /BLIGE	STEERING & CONTROLS	BODY	ACCESSORIES SERVICE TOOLS	CHEMICAL
---------------------	-------------------	--------------------	---------	------------------------	------------	---------------------	------------------------	------	------------------------------	----------

SEA-DOO 4-STROKE • ENGINE • FUEL SYSTEM

Sea-Doo Spark Parts & Accessories are now in the new Sea-Doo Spark feature section pages 6-9



RIVA RISING RATE FUEL PRESSURE REGULATOR KIT

RIVA's Fuel Pressure Regulator Kits provide the precision pressure control necessary to compliment a variety of performance applications. Kits are fully assembled & mount securely via sturdy stainless steel bracket. High quality billet pressure regulator can adjust base pressure from 25 to 80 PSI. Unit can also be set up as rising rate fuel pressure regulator at a 1 to 1 ratio providing one additional pound of fuel pressure for every pound of boost gain. Plugs directly into original fuel system with OEM connectors and features a large 3/8" fuel return line. Includes integrated liquid-filled pressure gauge and billet Fuel Pressure Regulator Block-off necessary for removal of stock fuel pressure regulator.

Key Features Include:

- Precision fuel pressure control with optional rising rate function.
- High quality stainless steel liquid-filled pressure gauge.
- Large 3/8 fuel return line.
- Billet Fuel Pressure Regulator Block-off.
- Easy bolt-on installation with OEM fuel connectors.
- Complete installation instructions & tuning guide.

Description	Part No.
RIVA Fuel Regulator Kit - 07 & Older 215	RS12050RRFPR07
RIVA Fuel Regulator Kit 08 & Newer 215/255/260/300 (RXP-X300/RXT-X300)	RS12050RRFPR08



SEA-DOO POWERSHOT ADJUSTABLE FUEL TUNER

The R&D Powershot fuel injection tuner will deliver increased horsepower, acceleration, and stronger mid-range performance by delivering a higher performing air to fuel ratio (A.F.R.) to

the engine. Many of today's high performance fuel injected four stroke muscle craft have a lean A.F.R. R&D Performance has tested, documented, and analyzed the O.E.M. fuel maps on every current fuel injected four stroke watercraft, and pre-programmed and coded the new R&D Powershot fuel injection control module to safely alter the O.E.M. fuel map to a higher performing and safer A.F.R. (richer). More horsepower, greater acceleration and stronger mid-range are the result when the proper A.F.R. is achieved and is tuned for optimum performance.

The R&D Powershot is fully adjustable on the fly (with the engine running, observed and tuned while riding), and will accommodate a wide range of adjustability to properly performance tune the A.F.R. for any combination of aftermarket parts. The R&D Powershot will add horsepower, reliability, and adjustability to any electronic fuel injected two or four stroke watercraft engine.

*Competition use only

Description	Part No.
R&D RXP/RXT 215HP Powershot Adj. Fuel Tuner	803-95002
R&D RXP-X/RXT-X 255HP Powershot Adj. Fuel Tuner	803-95003
R&D RXP-X 2012/RXT-aS/iS Powershot Adjustable Fuel Tuner	803-95004
R&D Spark Fuel Tuner	803-95010



PRO-SERIES FUEL FILTER

- CNC construction from billet aluminum.
- Replaceable 10-micron filter element.
- Easy disassembly.
- Viton o-ring seal.
- Accepts 3/8" fuel line.
- Anodized to prevent corrosion.
- Includes mounting hardware.

Description	Part No.
RIVA Pro-Series 3/8" Universal Fuel Filter	RY12040-BFF
RIVA Pro-Series 3/8" Replacement Filter	RY12040-BFF-FE



EVENT PROMOTOR JIM RUSSELL OF DSM EVENTS SIGNALS THE LE MANS-STYLE START OF THE 2015 HOT PRODUCTS IJSBA MARK HAHN MEMORIAL HAVASU 300 ENDURANCE RACE.

SEA-DOO 4-STROKE • ENGINE • FUEL SYSTEM

Sea-Doo Spark Parts & Accessories are now in the new Sea-Doo Spark feature section pages 6-9



RS12050-I-KIT-50



RS12090-I-KIT-100

RIVA PRO-SERIES FUEL INJECTOR KITS

Description	Part No.
100lb p/hr - All iControl Models, RXP-X/RXT-X 260/300	RS12090-I-KIT-100
50lb p/hr - 255/215 non iControl Models	RS12050-I-KIT-50
42lb p/hr - 215 non iControl Models	RS12050-I-KIT-42-1



RS12050-340FP-08

RS12050-340FP-07

RIVA HIGH VOLUME FUEL PUMPS

RIVA's High Volume Fuel Pump Kits feature Aeromotive's state-of-the-art 340 "Stealth" Fuel Pump. This high output pump delivers 340LPH to support modified supercharged & turbocharged engine packages. Aeromotive pumps utilize a turbine pumping mechanism that increases durability and fuel delivery. Both kits include fuse protected marine grade wiring harness with waterproof relay system to allow activation by aftermarket ECUs. Kit for '08 & newer models (shown above) features billet fuel system adapter required for installation of Aeromotive pump. Detailed installation instructions and all hardware necessary for installation supplied with each kit.

Description	Part No.
2008 & Newer Models RXP-X/RXT-X 260/300	RS12050-340FP-08
2003-07 Models	RS12050-340FP-07



SEA-DOO INTAKE MANIFOLD GIRDLER

WORX Racing's NEW Sea-Doo 4-Tec Intake Manifold Girdle Kit provides added strength to the Sea-Doo intake manifolds. The bracket clamps around the side of the manifold easily without drilling or grinding of the stock manifold, providing extra support to the join in the manifold that splits under higher boost pressures on skis with aftermarket superchargers or running higher RPMs.

Description	Part No.
Sea-Doo Intake Manifold Girdle	WR04005



ECU Bracket Sold Separately
RS12050-BIM-EMK

RIVA/WILSON BILLET INTAKE MANIFOLD



RS12050-BIM-SIB

Manifold includes fuel rail brackets designed to fit RIVA 75lb & 100lb Pro Series Injectors. Optional Fuel Rail Bracket Kit (RS12050-BIM-SIB) sold separately for use of OEM length/style injectors.

Optional Universal ECU Bracket (RS12050-BIM-EMK) sold separately.

Description	Part No.
RIVA/Wilson Billet Intake Manifold All 215/255/260/300 4-Tec Engines	RS12050-BIM-1
RIVA Universal ECU Bracket	RS12050-BIM-EMK
RIVA OEM Sea-Doo Fuel Injector Bracket for RS12050-BIM (Sold as Set)	RS12050-BIM-SIB



RIVA SEA-DOO HIGH FLOW BILLET FUEL RAIL

- High flow fuel delivery supports more power
- Fits all Sea-Doo OEM injectors along with RIVA Pro-Series fuel injectors
- Delivers equal fuel supply to injectors with flow-through fuel routing
- Billet aluminum construction and anodized to prevent corrosion
- Can also be used on stock engine with stock injectors for cosmetic upgrade

Applications: All Sea-Doo 1.5 liter 4-tec engines

Description	Part No.
RIVA High Flow Billet Fuel Rail	RS12050-BFR

WSM OEM REPLACEMENT FUEL PUMP

OEM# 270600041, 270600056, 270600087, 270600031
Fits: GTI 1503 (2006-07), GTX 1503 (2002-07), RXP 1503 (2004-07), RXT 1503 (2005-07)



Description	Part No.
2003-07 Models, Sea-Doo 4-Tec Fuel Pump	004-800

SEA-DOO
4 STROKE

INTAKE
SYSTEMS

ENGINE/
GASKETS

EXHAUST

DRIVE LINE
HANDLING

ELECTRICAL

WATERLINE
/BILGE

STEERING
& CONTROLS

BODY

ACCESSORIES
SERVICE TOOLS

/HARDWARE

CHEMICAL

SEA-DOO 4-STROKE • ENGINE

Sea-Doo Spark Parts & Accessories are now in the new Sea-Doo Spark feature section pages 6-9

SEA-DOO
4 STROKE

INTAKE
SYSTEMS

ENGINE/
GASKETS

EXHAUST

DRIVE LINE
HANDLING

ELECTRICAL

WATERLINE
/BILGE

STEERING
& CONTROLS

BODY

ACCESSORIES

SERVICE TOOLS
/HARDWARE

CHEMICAL



RIVA PRO-SERIES 4-STROKE CYLINDER HEAD GASKETS

RIVA's Pro-Series Cylinder Head Gaskets were developed to withstand severe heat & pressure generated by high-boost and high horsepower applications delivering maximum reliability to your racing engine.

Key Benefits Include:

- Three layer stainless construction for durability & corrosion resistance.
- Viton coated & embossed surfaces for maximum sealing.
- Unique design promotes even torque & requires no re-torque.

Description	Part No.
RIVA Sea-Doo 260/255/215 Pro-Series Head Gasket (Standard Bore)	RS10050CHG1503

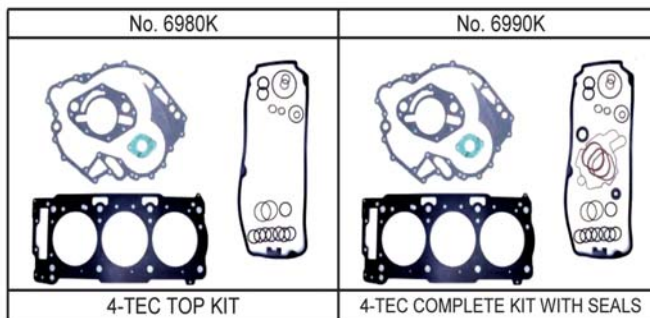

GASKET TECHNOLOGY SEA-DOO 4-TEC GASKETS & GASKET KITS

Description	OEM No	Part No.
Aluminum Washer Kit	----	6943K
4-Tec Top End Gasket Kit	----	6980K
4-Tec Complete Gasket Kit With Seals	----	6990K
Head (Standard Bore)	420950770	6900*
Valve Cover	420950820	6905*
Oil Pump Housing	420950970	6910*
Oil Separator Cover	420630540	6915*
Timing Drive Cover	420931130	6920*
Oil Seal	420650310	6956
Output Sleeve Seal	420630550	6958
Oil Pump O-Ring	420631480	6959
Intake O-Ring - 3 Required	420950740	6960
Intake O-Ring Kit	----	6961K
Seal Kit	----	6962K

** Denotes when the gasket is included in the Top End Gasket set.*



007-626



007-399-05

WSM SEA-DOO 4-TEC COMPLETE GASKET KIT

WSM Sea-Doo 4-Tec Gasket Kit includes outer oil seals and are an economical solution to OEM gasket kits.

Description	Part No.
WSM Sea-Doo Complete Gasket Kit (Kit includes all items listed below)	007-626
WSM Sea-Doo Top End Gasket Kit (Kit includes all items listed, up to and including 008-605-01)	007-626-01

Part No.	O.E. No.	Description	Req'd
004-174-01	420460830	Ignition Coil Rubber Boot	3
007-399-06	290950820	Valve Cover Gasket	1
008-600-01	420950870	Cam Sensor O-Ring	1
008-600-09	420630125	Cam Sensor V Ring	1
010-050	420630200	Valve Stem Seal	12
007-399-05	420950770	Cylinder Head Gasket	1
007-574-03	290950792	Throttle Body Gasket	1
007-573-05	290950740	Intake Rubber Ring	3
008-605-01	420631780	Throttle Positioning Sensor O-Ring	3
008-400	420250015	Engine Block Aluminum Washer	1
008-600-02	420631300	Crankcase O-Ring	1
008-600-03	420430405	End Cap O-Ring	1
007-588-01	420430623	Drain Plug Gasket	1
008-600-04	420250055	Crankcase O-Ring	1
008-600-05	420631310	Starter O-Ring	2
008-600-06	420950810	Dip Stick Tube O-Ring	2
008-604	420630550	Crankshaft Sealing Ring	1



RIVA PRO-SERIES 4-STROKE CYLINDER HEAD STUD KITS

RIVA's ultra high strength cylinder head stud kit is essential equipment when upgrading internal components on your high boost Yamaha engine. Precision machined from premium grade 8740 alloy and heat treated to exacting tolerances, these studs dramatically increase reliability & ease of maintenance. Key Benefits Include:

- Superior material & heat treat process provides 10X better strength than OEM
- Studs provide improved alignment of cylinder head and gasket
- More accurate & consistent torque loading provides a more uniform clamping force on head gasket.
- Helps prevent blown head gaskets and assures optimum engine sealing.

Description	Part No.
RIVA Pro-Series Cylinder Head Stud Kits Sea-Doo 260/255/215	RS10050-HSK

SEA-DOO 4-STROKE • ENGINE

Sea-Doo Spark Parts & Accessories are now in the new Sea-Doo Spark feature section pages 6-9



CP SEA-DOO PISTON KITS

Description	Piston	Piston Pin	Locks	Rings
100mm standard bore (1494cc) 8.4:1	M9032A	905-2250-19CP3C	905-073SWL	CPN-3937
100mm standard bore (1494cc) 9.5:1	M9039A	905-2250-19CP3C	905-073SWL	CPN-3937
Oversize Pistons				
100.25mm +.25mm oversize (1501cc) 8.4:1	M9033	905-2250-19CP3C	905-073SWL	SWF20064-3
100.25mm +.25mm oversize (1501cc) 9.5:1	M9040	905-2250-19CP3C	905-073SWL	SWF20064-3
100.50mm +.50mm oversize (1508cc) 8.2:1	M9041	905-2250-19CP3C	905-073SWL	CPN-3957
100.50mm +.50mm oversize (1508cc) 9.5:1	M9042	905-2250-19CP3C	905-073SWL	CPN-3957

*Sold 3 piston kits per set.

**Piston sold complete with: rings, piston pin and locks



WISECO SEA-DOO PISTON KITS 2004-2010 RXP/RXP-X/RXT/RXT-X

Features

- Dedicated forging
- Stock Compression
- Dome design
- Chrome plated piston pin
- Horizontal slot pin oiling
- Pressure seal groove
- ArmorGlide™ Skirt Coated
- Dedicated rings

Benefits

- Light weight, superior strength, optimized design
- Matches OEM compression ratio
- Improved flame travel to maximize air/fuel burn efficiency
- Reduced friction, improved scuff resistance
- Improved lubrication, better pin oiling, reduced friction
- Maximum ring seal
- Reduced friction, quieter operation, improved scuff resistance
- Optimized for each application, lightweight, high performance, better oil control

Sea-Doo Model	Years	Bore Size (mm)	Piston Kit Number	Replacement Ring Set	Pins & Clips
RXP 215	2004-09	100.00	40038M10000*	3937XS	Wrist Pin
RXP-X 255	2008-10	100.50	40038M10050*	10050XS	S626
RXT 255/260	2005-10	101.00	40038M10100*	10100XS	Circlips W5860
RXT-X 255/260	2008-10				
RXT 215	2008-10				
RXT IS 255	2009				

8.4:1 Stock Compression ratio ArmorGlide™ Skirt Coated

Piston sold complete with: rings, piston pins, and circlips

Sea-Doo Model	Years	Bore Size (mm)	Piston Kit Number	Replacement Ring Set	Pins & Clips
RXP 215	2004-09	100.00	40108M10000*	3937XS	Wrist Pin
RXT-X 155	2008-12	100.50	40108M10050*	10050XS	S626
RXT 155	2005-12	101.00	40108M10100*	10100XS	Circlips W5860
RXP-X 155	2008-12				
RXP 155	2008-09				

10:1 Compression ratio ArmorGlide™ Skirt Coated

Piston sold complete with: rings, piston pins, and circlips

*Sold individually



JE PISTON KITS FOR SEA-DOO

PISTON KIT #	DISP.	BORE SIZE	OVER SIZE	COMP. RATIO	RING #
308432	1493cc	100mm	STD	8.4:1	JG3701-3937
308433	1493cc	100mm	STD	9.5:1	JG3701-3937
308434	1493cc	100mm	STD	10.0:1	JG3701-3937
308435	1501cc	100.25mm	+.25mm	8.4:1	----
308436	1501cc	100.25mm	+.25mm	9.5:1	----
308437	1501cc	100.25mm	+.25mm	10.0:1	----
308438	1508cc	100.5mm	+.5mm	8.4:1	----
308439	1508cc	100.5mm	+.5mm	9.5:1	----
308440	1508cc	100.5mm	+.5mm	10.0:1	----

*Sold 3 piston kits per set.

**Piston sold complete with: rings, piston pin and locks



PRO-X OEM REPLACEMENT FOUR STROKE PISTONS

- 2004-09 RXP
- 2008-09 RXP-X 225
- 2010-12 RXT-X 260 RS
- 2005-09 RXT
- 2010-12 RXP-X 255

Description	Size	Part No.
Pro-X 4 Stroke Pistons Standard	100.00mm	01.5594.000
Pro-X 4 Stroke Pistons 1st Over	100.50mm	01.5594.050
Pro-X 4 Stroke Pistons 2nd Over	101.00mm	01.5594.100

Compression 8.4:1

*PRO-X piston kits sold individually.



CARRILLO CONNECTING RODS

Description	Part No.
Carrillo Connecting Rod Set	RO-RXP>-8M4724S-03
Sea-Doo 255, 215 HP (Sold 3 rods per set)	



RIVA SEA-DOO 4-TEC REPLACEMENT SLEEVE

Our high-quality ductile iron replacement sleeves are considerably harder and more abrasion resistant than OEM sleeves, providing excellent oil retention, ring seal and the ultimate in leak down performance. Accepts pistons for stock bore up to 100.44mm.

Description	Part No.
Sea-Doo 4-Tec Replacement Sleeve	RS10050-SLV-1503

SEA-DOO 4 STROKE
INTAKE SYSTEMS
ENGINE/GASKETS
EXHAUST
DRIVE LINE HANDLING
ELECTRICAL
WATERLINE /BILGE
STEERING & CONTROLS
BODY
ACCESSORIES SERVICE TOOLS /HARDWARE
CHEMICAL

SEA-DOO 4-STROKE • ENGINE

Sea-Doo Spark Parts & Accessories are now in the new Sea-Doo Spark feature section pages 6-9



RIVA SEA-DOO VALVE TRAIN UPGRADE KIT

RIVA's Valve Train Upgrade Kit increases the reliability of your modified engine by reducing the possibility of valve float at high rpm. Includes lightweight, precision-machined titanium valve retainers, racing valve springs, base washers and OE rocker arm shaft bolts that must be replaced during installation.

Description	Part No.
RXP/RXT/GTX Valve Train Upgrade Kit	RS19050-VTU
RXP-X/RXT-X 260/300	



R&D HIGH PERFORMANCE TITANIUM RETAINERS

- Increased spring preload at seat and full lift
- Designed to work with stock valve springs for pro stock class racing
- Increased valve control
- 50 percent lighter than stock, much stronger
- Will work with camshaft specs up to .340 - .350 lift
- Installs using O.E.M. valve locks
- Installs on all 2012+ RXP-X/RXT-X/iS aS

Description	Part No.
R&D Titanium Retainer Kit	613-80014



RIVA SEA-DOO STOCK VALVE RETAINER KIT

RIVA's Valve Retainer Upgrade Kit increases the reliability of your engine by reducing the possibility of valve float at high rpm. Includes 12 lightweight, precision-machined titanium valve retainers and 6 OE rocker arm shaft bolts that must be replaced during installation. A must for IJSBA & APBA Stock Class race craft.

Description	Part No.
RIVA Stock Valve Retainer Kit SD RXP/RXT/GTX	RS19050-SRU-1
RXP-X/RXT-X 260/300	



R&D TITANIUM RETAINERS AND VALVE SPRINGS

- Increased spring preloads at seat and full lift
- Designed to work as a dual valve spring spec for Pro Limited class racing
- Increased valve control
- 50 percent lighter than stock, much stronger
- Will work with camshaft specs up to .400 lift
- Installs using O.E.M. valve locks
- Installs on all • Installs on all 2012+ RXP-X/RXT-X/iS aS

Description	Part No.
R&D Valve Spring Titanium Retainer Kit	613-80015



RIVA SEA-DOO HIGH PERFORMANCE VALVE SET

RIVA High Performance Valve Kits are engineered to improve reliability and performance in high-boost supercharged & turbocharged engines. Intake valves are built from high grade EV-8 (24-4N) stainless that is extremely resistant to corrosion. Exhaust valves are built from inconel alloy (IN-751) that is highly resistant to heat

damage. Valve heads have been redesigned for increased air flow and durability. Valve stems feature hard-chrome plating for superior wear & lubricity. Kits include high strength valve locks, precision machined from 4130 chromoly.

Drop-In Valve Kits: Direct drop-in replacement valves require no machining of cylinder head.

Oversized Valve Kits: +1mm Intake & +2mm Exhaust valves deliver more air flow (requires machining of cylinder head).

Key Features:

- Stronger & lighter than stock valves.
- Redesigned valve heads for improved air flow & strength.
- High grade stainless intake valves resist corrosion.
- Inconel exhaust valves resist heat from high boost applications.
- Valve stems are hard-chrome plated for improved wear.
- Includes high strength valve locks.
- Sold in sets of 12 (6 Intake/6 Exhaust).

Description	Part No.
RIVA Sea-Doo High Performance Valve Set (Standard/Drop-in)	RS19050-HPV-0
RIVA Sea-Doo High Performance Valve Set (+1mm Intake / +2mm Exhaust)	RS19050-HPV-1:2



PRO-X SEA-DOO OEM REPLACEMENT STEEL VALVES

Manufactured by the leading OEM factories in Japan. Made to exact OEM specs and tolerances. The steel valves are a direct and cost efficient OEM replacement.

Description	Part No.
Pro-X Sea-Doo Exhaust Valves	28.5594-1
Pro-X Sea-Doo Intake Valves	28.5594-2

*Pro-X Sea-Doo Replacement Valves are sold individually.

SEA-DOO 4-STROKE • ENGINE

Sea-Doo Spark Parts & Accessories are now in the new Sea-Doo Spark feature section pages 6-9

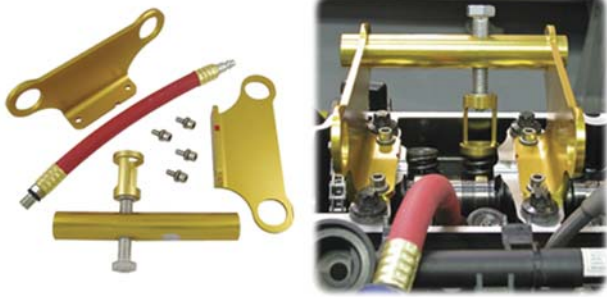

SEA-DOO 4-TEC VALVE COMPRESSION TOOL

RIVA's overhead Valve Compression Tool allows easy removal of valve springs and keepers without removing cylinder head. Includes compression adapter to pressurize cylinder keeping valves in place during removal of stock springs and keepers.

Description	Part No.
RIVA 4-Tec Valve Compression Tool	RS19050-VCT



WSM OEM REPLACEMENT SEA-DOO 4-TEC (1503) VALVE STEM SEAL

OEM replacement valve stem seal (OEM# 420630200) Sold individually.

Description	Part No.
Sea-Doo 4-tec Valve Stem Seal	010-050



WSM OEM REPLACEMENT SEA-DOO 4-TEC STARTER DOUBLE GEAR

OEM replacement (OEM# 420834874).

Description	Part No.
Sea-Doo 4-tec Starter Double Gear	004-360



Description	Part No.
A. NGK Standard Plug for Sea-Doo GTX 4-Tec (10 plugs per box)	DCPR-8E
A. Sea-Doo Spark (10 plugs per box)	CR8EB
B. NGK Iridium Spark Plugs (4 plugs per box)	DCPR8EIX
C. Nippon Denso Iridium Plug (4 plugs per box)	IXU24



RIVA FLYWHEEL BOLT UPGRADE KIT

High strength bolt kit directly replaces OEM flywheel bolts that are prone to shearing off on modified Sea-Doo 1503cc and Yamaha 1.8 liter engines. Superior materials and design improve durability and reliability. A must for endurance, closed course and HydroDrag race craft! Sold as a set of 6.

Description	Part No.
RIVA Flywheel Bolt Upgrade Kit for Sea-Doo 1503cc and Yamaha 1.8 Liter Engine	RY10840-FWB



K&N REPLACEMENT AFTERMARKET OIL FILTERS

Description	OEM#	Part No.
K&N Filter - All Sea-Doo 4-stroke	420956741	KN556



WSM OEM REPLACEMENT AFTERMARKET OIL FILTERS

Description	Part No.
D. WSM Filter - All Sea-Doo 4-stroke	006-560
E. WSM Filter - All Sea-Doo 4-stroke Oil Filter Cap	006-562

SEA-DOO OEM TYPE SPECIALTY TOOLS

For the installation and removal of pistons, rocker arms, cam chain and cam gear.



Crankshaft Locking Tool Part No. 950-125 O.E. No. 529-035-821 Fits: All 4 Tec's	Camshaft Locking Tool Part No. 950-180 O.E. No. 529-035-839 Fits: 4-Tec Engines
---	---

For the installation and alignment of Sea-Doo engines.



Alignment Shaft Part No. 950-140 O.E. No. 295-000-141 Fits: All Models	Alignment Adaptor Part No. 950-150 O.E. No. 529-035-719 Fits: GTX 4-Tec Models	Alignment Support Plate kit Part No. 950-135 O.E. No. 529-035-506 Fits: All Models
--	--	--

See page 319 for additional WSM tools.

SEA-DOO 4-STROKE • CONTROL

Sea-Doo Spark Parts & Accessories are now in the new Sea-Doo Spark feature section pages 6-9



UMI TOP STOP BILLET STEERING

Top stop steering for positive control and extraordinary strength. Improved handling by shifting weight to correct point on watercraft.

Description	Part No.
GSX, GTX, GTI, GTS, GSI, GS 96+, RX, RXP155/215, RXP-X255, RXT215, RXT-X255 (08-11)	SD-04804-GSX



DO SPEED SPACER AND MOUNTING KIT FOR UMI RXP-X/RXT-X STEERING SYSTEMS

Do Speed has developed this spacer and mounting bracket specifically to be used in combination with a UMI steering system on a RXP-X or RXT-X. The spacer prevents water from entering the engine compartment and the bracket creates a clean and safe installation of the OEM Sea-Doo warning system signal.



Description	Part No.
A. IDO Speed Spacer and Mount Kit for UMI RXP-X and RXT-X Steering System	D-X-P
B. Replacement Hood Latch Bracket	SD-44805



RIVA SEA-DOO BILLET ICONTROL LEVERS

RIVA's billet lever set for Sea-Doo iControl models provides superior control and comfort along with cutting edge styling. Directly replaces the OEM plastic parts with high quality CNC machined throttle and brake levers. Features more responsive stainless steel return spring for a precision feel. Gunmetal gray anodized coating prevents corrosion. Installs easily with included instructions. This item also fits the Sea-Doo Spark.

Description	Part No.
RIVA Lever Kit, Throttle/Brake for iControl	RS24090-ICL



RXP-X 260 PRO-SERIES STEERING SYSTEM

Key Features Include:

- Aluminum & Stainless Steel construction deliver superior strength & rigidity.
- Variable tilt adjustment.
- Accepts both 7/8" bars & 1-1/8" fat bars.
- Hollow steering shaft design accommodates OEM wiring harness.
- Billet aluminum steering arm features adjustable "quick turn" settings.
- Retains "Off Throttle Assisted Steering" system.
- Cutting-edge race styling.
- All aluminum parts anodized to prevent corrosion.
- Color: Black



RS24090-ICRT



Scan QR Code to find video for RIVA RS20110 & RS202GM-IC

Description	Part No.
RXP-X 260/300 Pro-Series Steering System	RS20110
RXP-X 260/300 (T3)	
Sea-Doo iControl Removal Tool	RS24090-ICRT



SPEED MAGIC "X MOUNT" STEERING HEAD

Description	Part No.
Speed Magic Steering Head RXP-X 255, RXT-X 255	SE-027015



SEA-DOO 4-TEC HANDLEBAR EXTENSION SET

Allows easy installation of popular ODI 130mm grips. Sold as a pair, grips sold separately. Fits all Sea-Doo models except Spark.

Description	Part No.
Handlebar Extension Set	RS24100-BES
All 4-tec (Except Spark)	

SEA-DOO 4-STROKE • CONTROL

Sea-Doo Spark Parts & Accessories are now in the new Sea-Doo Spark feature section pages 6-9



HOT PRODUCTS RUNABOUT HANDLEBARS

Models	Color	Pad Size	Part No.
Sea-Doo GTS/GTX XP 97-98/RXP/RXT	Silver	Large	HJR-02
Handle Bar Specs: 30.75" width • 3" Rise • 1.5" Pull Back			
Sea-Doo GTS/GTX XP 97-98/RXP/RXT	Black	Large	HJR-NW-83BK
Handle Bar Specs: 33" width • 4" Rise • 2.75" Pull Back			



RIVA HANDLEBAR FOR iCONTROL SKIS

RIVA's Sea-Doo iControl Handlebars are CNC constructed from lightweight aluminum and stronger than stock bars. Ends are knurled for better grip adhesion. Pre-drilled and tapped to accept stock iControl mounts. Includes bolt-on cross-bar that increases strength and impact protective foam pad. Available in 32" width in black.

To ease transfer of iControl housings RIVA offers a special iControl Removal Tool (part # RS24090-ICRT). See page 28.

Description	Part No.
RIVA Handlebar, iControl RXP-X260/300, RXT-X260/300, Black	RS205B-IC



UMI RXP TRIM/SWITCH HOUSING

UMI's trim/switch housing is machined from 6061-T6 billet aluminum, replacing the stock plastic housing. Trim/switch housing uses the factory variable trim switch and start/stop switch. This housing must be used with the UMI GSX/RXP (Part # 58-6321) steering system, aftermarket bars and finger throttle.

Description	Part No.
UMI RXP Trim/Switch Housing	SD-01600-CLR

SEA-DOO START/STOP SWITCH HOLDER

Sea-Doo Start/Stop Switch Housing

- Solid billet anodised construction
- Utilizes small Sea-Doo switch panel and late model (thick) red button
- 2 piece bar clamp style for adjustability
- Great for start/stop button on custom skis/ launch control button, etc.
- Can be used on either side of the handle bars



Description	Part No.
Sea-Doo Start/Stop Switch Holder	WR06015

SEA-DOO ELECTRONIC iBR LEVER ASSEMBLY & THROTTLE LEVER ASSEMBLY

WORX Racing's all new billet anodised iBR (reverse) and anodised iTC (throttle) electronic actuator housing, which utilizes OEM electronic actuators up on the handle bars (no throttle cables required).

- Billet anodised construction
- Utilizes OEM electronic actuator which drops into new housing for OEM electronic trigger feel
- Suits all Sea-Doo models with iBR or iTC
- Clamp on handle bar design allows for adjustability of throttle position and angle



WR06011



WR06010

Description	Part No.
Sea-Doo Electronic iBR (Reverse) Lever Assembly	WR06011
Sea-Doo Electronic iTC (Throttle) Lever Assembly	WR06010



WR06013



WR06012

* Switch is not included * Lever sold individually

Description	Part No.
Sea-Doo Right Switch Panel Holder	WR06012
Sea-Doo Left Switch Panel Holder	WR06013



HANDLEBAR COVER CAP FOR SEA-DOO 4-TEC RXP - RXT - GTX - GTI



Description	Part No.
Handlebar Cover Cap	FB001-SD

SEA-DOO
4 STROKE

INTAKE
SYSTEMS

ENGINE/
GASKETS

EXHAUST

DRIVE LINE
HANDLING

ELECTRICAL

WATERLINE
/BILGE

STEERING
& CONTROLS

BODY

ACCESSORIES
SERVICE TOOLS

/HARDWARE

CHEMICAL

SEA-DOO 4-STROKE • HANDLING

Sea-Doo Spark Parts & Accessories are now in the new Sea-Doo Spark feature section pages 6-9



R&D SEA-DOO AQUAVEIN SCOOP GRATE

Description	Part No.
GTX 4tec All RXP 215,155	113-95001
RXP 215 PRO 2 Aquavein & Girdle Kit	113-95002
RXP 215 Aquavein Girdle Kit (Girdle only)	123-10010
02-09 GTX 4-TEC All Models,	113-95000
07-08 GTX 155/215, 07-08 GTX Ltd,	
07-08 GTX Std & Wake, 02-03 GTX DI, 09 Wake Pro	
RXP-X 255, RXT-X 255	113-95004
GTI 06-09	113-95003
GTX iS (09), GTX iS Ltd 260 (10+),	113-95006
RXT iS 260 (10-12), RXT-X 260 (10-13)	
RXP-X 255/RXT-X 255 Pro 2 Deep Closed Course Race	113-95007
RXP-X 260 (2012+) (T3)	113-95008



TBM RACING SEA-DOO RXP-X/RXT-X TUNABLE SUPER SCOOP

This scoop grate will fit all year RXP-X 255 (08-11) and RXT-X 255 (08-10). This Super Scoop will give you outstanding hook up and drive through the chop with a reasonable gain in top speed. You have the option to tune the scoop for water conditions with the removable rear inlet wedge. With the wedge installed you gain the ultimate hook up and rough water handling.

Description	Part No.
RXP-X 255/RXT-X 255	TBM100-SD

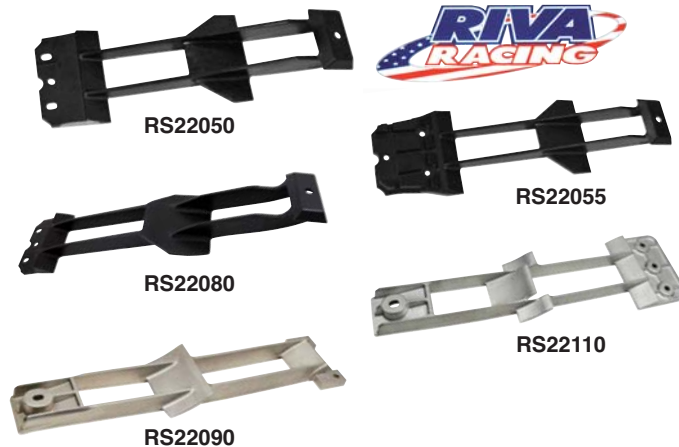

RIVA TOP-LOADER INTAKE GRATES

Description	Part No.
RXP 215 (04-08)	RS22050
RXT 215 (05-08)/GTX-SC (03-04)	RS22055
RXP-X 255/RXT-X 255HP (non iControl Models)	RS22080
RXT/GTXC (S3 Hull), RXT-X260/300 (Stainless Steel)	RS22090
RXP-X 260/300 (Stainless Steel)	RS22110



WORX MAXILOADER INTAKE GRATE

Description	Part No.
'02 on 4Tec GTX, GTX LTD, 07 Wake RTX GTX	WR221
RXP 215 (04-08)	WR223
GTI (06+), GTI SE	WR226
RXP-X (08-09), RXT-X (08-09)	WR229
RXT iS 225 & GTX Ltd iS 255 (09), GTX 155 (10), RXT 215, Wake Pro 215, GTX 215 iS, RXT 260 iS, GTX Ltd 260 iS, RXT-X 260 RS	WR235
RXP-X (2012+)	WR238
GTR 215 (2012+)	WR243

SEA-DOO 4-STROKE • HANDLING

Sea-Doo Spark Parts & Accessories are now in the new Sea-Doo Spark feature section pages 6-9



RIVA SEA-DOO 4-TEC OPEN LOOP COOLING KIT

RIVA Open Loop Cooling Kit dramatically reduces engine operating temperatures for improved performance & reliability.

Also allows installation of RIVA Performance Ride Plate by eliminating need for heat exchanger. Original closed loop system becomes quickly heat soaked in high performance applications. Open loop system increases cooling efficiency via steady supply of cool external water.

Note: Water routing is designed for engine running up to 8,650 rpm.
FITS ALL SEA-DOO 4-STROKE PWC with a stock ride plate

Description	Part No.
RIVA 4-Tec Open Loop Cooling Kit	RS1013-50-1
RIVA 4-Tec Open Loop Cooling Thermostat only	RS1013-50-TK



RXP-X 260/300 FIXED BILLET TRIM TABS

- CNC construction from billet aluminum.
- Will not warp or distort.
- More consistent planing surface.
- IJSBA legal for all classes.

Description	Part No.
RXP-X 260/300 Fixed Billet Trim Tabs	RS27110-FPT



R&D RXP-X 260/300 RIDE PLATE TRIM PADS

Improve the overall handling of the RXP-X 260 by adding the R&D extended Trim Pads. The extended length eliminates bow search and improves high speed stability in smooth or rough water conditions. The new Ride Plate Trim Pad design will promote smoother and quicker planing under aggressive 0-30mph acceleration, produce an overall more stable ride, offer improved cornering, and increase top speed averages.

Description	Part No.
R&D Ride Plate Trim Pads for RXP-X 260/300	123-80622



RIVA RACING RXP/RXP-X/RXT/RXT-X/GTX PRO-SERIES SPONSON KIT

Description	Part No.
A. SD RXP/RXP-X/RXT/RXT-X/GTX (2008-11)	RS26050
B. RXP-X 260 (T3) (2012), Fits 300 RXT-X 260/RXT-X aS 260 (S3) (2012)	RS26110



O.P.A.S. PERFORMANCE BLOCK-OFF KIT

Improves handling characteristics for competition use. Necessary to accommodate RIVA Rear Exhaust Kit (RS15050-1). Also designed to cleanly and easily cover the openings left when O.P.A.S. is removed preventing water from entering the hull. Made from billet aluminum utilizing o-ring seals. Anodized to prevent corrosion.

Description	Part No.
SD RXP/RXT/GTX (2003 and newer) models	RS29050-1

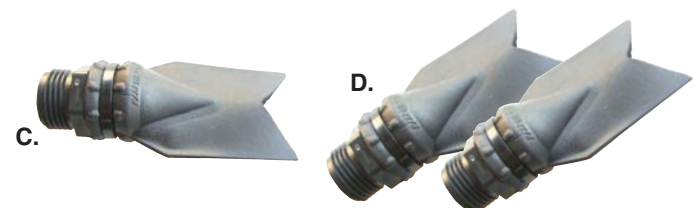

DUCK BILL DRAIN SYSTEM

Simple and clean, drains water from hull under acceleration.

Description	Part No.
C. Sea-Doo 2009+ 3 seat with i control, Single Drain	A7026
D. Sea-Doo 2009+ 3 seat with i control, Dual Drain	A7027

SEA-DOO 4 STROKE

INTAKE SYSTEMS

ENGINE/GASKETS

EXHAUST

DRIVE LINE HANDLING

ELECTRICAL

WATERLINE /BILGE

STEERING & CONTROLS

BODY

ACCESSORIES

SERVICE TOOLS /HARDWARE

CHEMICAL

SEA-DOO 4-STROKE • HANDLING • PUMP

Sea-Doo Spark Parts & Accessories are now in the new Sea-Doo Spark feature section pages 6-9



R&D RXP/RXP-X/RXT/RXT-X/GTX PRO SERIES SPONSON KIT

Description	Part No.
GTX (03-04), RXP	123-95100
RXP-X, RXT-X, GTX (05+), GTI (06), RXT (05+)	123-95101
RXP (05+)	
RXP-X (12-13)	123-95111



WORX RACING SEA-DOO SPINSONS

Description	Part No.
GTX All (2002-04), RXP (04)	WR526
GTX (05-13), RXP (05-06), RXT (05-06), GTI (06)	WR534
RXP-X (08), RXT-X (08)	WR540
RXT iS 225 & GTX Ltd iS 255 (09), GTX 155 (10), RXT 215, Wake Pro 215, GTX 215 iS, RXT 260 iS, GTX Ltd 260 iS, RXT-X 260 RS	WR545
RXP-X (2012+)	WR548



RIVA RXP/RXT PRO-SERIES REDUCTION NOZZLE

Ideal for tuning your Sea-Doo pump combination for maximize performance. The nozzle features a interchangeable ring system. Nozzle includes three stainless steel rings in 81, 82 and 83mm. Additional ring sizes available (RS23050-NR-SIZE) 80, 81.5, 82.5 and 84mm.

Description	Part No.
RIVA Venturi Nozzle w/3 Rings, RXP 215, RXP-X 255, RXT, GTX-SC (05-07)*	RS23050-N

* Not compatible with '09 & newer iControl models. Requires additional machine work for use with non-iControl RXT-X & RXT models.

GTX 4-TEC



R&D SEA-DOO RXT 2.5 DEGREE NOZZLE WEDGE KIT

The R&D 2.5 degree reduction nozzle wedge kit for the new Sea-Doo 4-Tec was designed, developed and tested extensively in all types of flat and rough water conditions to ensure that there would be no handling performance compromises. Most brands of watercraft have some form of V.T.S. (variable trim system) including other model Sea-Doos. Why the

4-Tec doesn't have a trim system is a mystery. Extensive testing has led the R&D development team to wedge the reduction nozzle up 2.5 degrees which will inexpensively give your 4-Tec better handling everywhere and provide a boost of 1 to 2 mph in top speed performance. The billet aluminum CNC machined 2.5 degree reduction nozzle wedge kit was designed to work with the OEM O.P.A.S. system and installs easily in 15 to 20 minutes with R&D's "easy install" directions.

Description	Part No.
R&D GTX 4-Tec SC (02-03), GTX 4-Tec N/A (03-05)	143-95002
2.5 Degree Pump Wedge/Cable Extension Kit	
R&D RXP 215	143-95003
2.5 Degree Pump Wedge/Cable Extender Kit	
R&D RXT 215/GTX 4-Tec (04-05)	143-95004
2.5 Degree Pump Wedge/Cable Extender Kit	
R&D RXT-X 255 2.5 Degree Pump Wedge/Adjustable Trim Rod/Cable Extender Kit	143-95005
R&D RXP-X 255 1.0 Degree Pump Wedge/Adjustable Trim Rod/Cable Extender Kit	143-95006



RIVA RXP/RXP-X, RXT/RXT-X, GTX-SC BILLET PUMP WEDGE

2 Degree wedge trims up your pump nozzle raising the bow of your craft for less drag and more control.

Description	Part No.
RIVA RXP, RXP-X 255, RXT 255, RXT-X 255, GTX-SC 2-Degree Pump Wedge	RS23050



RIVA RXP/RXP-X/RXT-X VTS EXTENSION ROD

RIVA's precision-machined VTS Extension Rod allows maximum "nozzle down" adjustment after installation of RIVA Pump Wedge. Necessary on modified craft to keep bow down during initial acceleration while still providing maximum top speed advantage when trimmed up. Adjustable design comes preset for RIVA 2° Pump Wedge (part# RS23050).

Description	Part No.
RIVA RXP/RXP-X 255/RXT-X 255 VTS Extension Rod	RS23050-1-ER

SEA-DOO 4-STROKE • PUMP

Sea-Doo Spark Parts & Accessories are now in the new Sea-Doo Spark feature section pages 6-9



WET WOLF PUMP CONE

The Adjust-A-Thrust has been shown to gain .5 to 1.5 more top end. Makes a noticeable difference in the low end and midrange as well.

Description Part No. SEA4
Wet Wolf Pump Cone fits all 2001-06 RXP, RXT, GTX and 4-Tec N/A and SC

*Note - This unit performs well on stock craft, and crafts with handling mods, or limited engine mods - We do not recommend this unit for modified craft.



R&D ULTIMATE PUMP SEAL

- Seals pump 100%
- Improved acceleration and holeshoot
- Eliminates cavitation
- Easy install directly to stock location
- Allows super fast Impellers to hook up without cavitation

Description	OEM#	Part No.
All 4-Tech (2003-08)	293200087	163-81500
All 4-Tech (2009), except 09 GTX LTD IS 255 & 09 RXT IS 255		
All GTI, RXP-X 255/RS, WAKE 155 (2010)		
GTI, GTS, RXP-X 255/RS, WAKE 155 (2011)		
All 4-Tech (2012-13)		
GTX LTD IS 255 & RXT IS 255 (2009)	293200122	163-81501
GTX, RXT, WAKE PRO 215 (2010-11)		



R&D ANTI-CAVITATION CONE FOR SEA-DOO

The unique patent pending design balances the bowl pressure in the last stage of the pump to eliminate detectable cavitation. Improve bottom end punch midrange pull and overall performance.

Description Part No. 163-95001
RXP 185/215, RXT 215, RXP-X 255, RXT-X 255, GTX, Pre 2009



WSM REPLACEMENT PUMP WEAR RINGS FOR SEA-DOO

Sea-Doo	O.E.M.	Part No.
580/650/720 (95-98)	271000290	003-500
800 Carb (95-98)/	(140mm ID)	
800 RFI (99-02)		
720 (99-05), 800 RFI (03-05)	271000653	003-503
951/4-Tec (02-03)		
4-Tec 130/155/185 HP (04-12)	267-000-104	003-502
	(155.5mm ID)	
4-Tec 215/255/260 HP (04-13)	267000105	003-499
	(159mm ID)	

SEA-DOO OEM TYPE SPECIALTY TOOLS

For the repair and installation of Sea-Doo 4-Tec drive shaft and the pump shaft.



Drive Shaft / Floating Ring
Part No. 950-100
O.E. No. 529-035-841
Fits: GTX 4 Tec Models

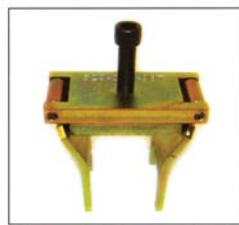

Drive Shaft / Floating Ring
Part No. 950-102
O.E. No. 529-035-987
Fits: Super Charged 4-Tecs



Drive Shaft Holder
Part No. 950-155
O.E. No. 529-035-986
Fits: GTX 4-Tec & RXP 4-Tec Models



Seal & Bearing Pusher
Part No. 950-165
O.E. No. 529-035-955
Fits: GTX 4-Tec Models



Shaft Pusher
Part No. 950-170
O.E. No. 529-035-819
Fits: GTX 4-Tec Models

See page 319 for additional WSM tools.



WSM REPLACEMENT PUMP WEAR RINGS WITH STAINLESS STEEL LINER

Sea-Doo	O.E.M.	Part No.
580/650/720 (95-98)	271000290	003-500S
800 Carb (95-98),	(140mm ID)	
800 RFI (99-02)		
720 (99-05), 800 RFI (03-05)	271000653	003-503S
951/4-Tec (02-03)		
4-Tec 130/155/185 HP (04-12)	267-000-104	003-502S
	(155.5mm ID)	
4-Tec 215/255/260 HP (04-13)	267000105	003-499S
	(159mm ID)	

SEA-DOO 4-STROKE • PUMP

Sea-Doo Spark Parts & Accessories are now in the new Sea-Doo Spark feature section pages 6-9



SOLAS STAINLESS STEEL REPLACEMENT WEAR RINGS FOR 4-TEC SEA-DOO

Description	Part No.
A. 155mm SR Series Wear Ring	SR-HS-156-01
B. 159mm SRX Series Wear Ring	SRX-HS-159-02



RIVA STAINLESS STEEL REPLACEMENT WEAR RING FOR 4-TEC SEA-DOO

Description	Part No.
155mm SD SR Series	RS33-155-SR
159mm SD SRX Series	RS33-159-SRX



RIVA/SOLAS SEA-DOO RACE PUMP & NOZZLE

- Increased acceleration & top speed
- Reduced cavitation through superior design
- 14-vein stainless steel stator section
- Includes matching 14-vein nozzle
- Features stainless steel wear ring for improved durability
- Utilizes standard 159mm pump impellers
- NOTE: Not for use on models with pump that bolts to ride plate (2009-11 RXT/GTX S3 models)
- Fits most 260, 255 & 215hp iControl models

Description	Part No.
Riva/Solas Sea-Doo Race Pump & Nozzle	SRZ-PM-159/83

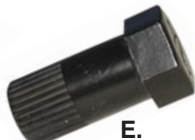

IMPELLER HOLDER TOOL

Description	Part No.
C. GTX 4-Tec Supercharged	DS#70
D. RXP/RXT 27mm	DS#71
E. Solas RXP/RXT 27mm	WR012-SRX



Skat-Trak
Performance Products

Check Page 174-175
For Flyboard Impellers
Applications

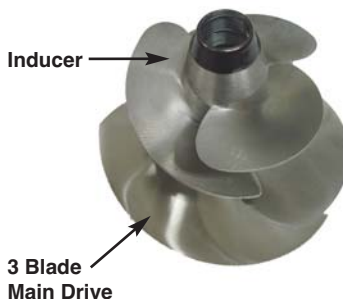

SKAT-TRAK TWIN IMPELLERS

The new Twin Prop design drives off the line much quicker than the traditional single prop, and offers substantial increase in rough water hookup.

SEA-DOO RXP-X 255

	Engine Mods	Pitch	Part No.
Main Drive	Stock	13/17	SS598328SWM1317
Main Drive	Limited	13/18	SS598328SWM1318
Main Drive	Supermod	15/20	SS598328SWM1520
	Engine Mods	Pitch	Part No.
Inducer	Stock	13/17	SS440ID1317
Inducer	Limited	13/18	SS440ID1318
Inducer	Supermod	15/20	SS440ID1520

SEA-DOO RXT-X 255

	Engine Mods	Pitch	Part No.
Main Drive	Stock	12/16	SS598328SWM1216
Main Drive	Limited	13/17	SS598328SWM1317
Main Drive	Supermod	15/18	SS598328SWM1518
	Engine Mods	Pitch	Part No.
Inducer	Stock	12/17	SS440ID1217
Inducer	Limited	12/17	SS440ID1217
Inducer	Supermod	15/18	SS440ID1518

SOLAS
Where Speed Begins



SOLAS TWIN IMPELLERS

Description	Part No.
RXP-X 260 (2012+), RXT IS 260/RXT-X 260 (2009+), RXT 260/RXT-X aS260 (2009+), GTX LTD iS 255 (2009+), GTX LTD iS 260 (2009+), RXP-X 255 (2009+)	SRZ-TP-15/21A

SEA-DOO 4-STROKE • PUMP

Sea-Doo Spark Parts & Accessories are now in the new Sea-Doo Spark feature section pages 6-9

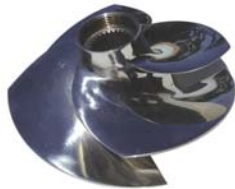

SOLAS IMPELLERS

Model	Year	Stock	Limited	Modified
RXT 215	05-08	SRX-CD-13/18	SRX-CD-14/19	SRX-CD15/21
RXT 215	09-10	SRZ-CD-13/18A	SRZ-CD-14/19A	SRZ-CD15/21A
RXTiS 260	09-10	SRZ-CD-15/21A	SRZ-CD-15/21A	-----
RXT-X 260	11-15	SRZ-CD-15/21A	SRZ-CD-15/21A	SRZ-CD-16/21A
RXP 215	04-08	SRX-CD-14/19	SRX-CD-14/19	SRX-CD15/21
RXP 215	09-10	SRZ-CD-14/19A	SRZ-CD-14/19A	SRZ-CD15/21A
RXP-X 255	08	SRX-CD-15/21	SRX-CD-15/21	-----
RXP-X 255	09-11	SRZ-CD-15/21A	SRZ-CD-15/21A	SRZ-CD-16/21A
RXP-X 260	12-15	SRZ-CD-15/21A	SRZ-CD-15/21A	SRZ-CD-16/21A
Spark	14-15	SK-CD-12/17	SK-CD-12/17	-----

All SOLAS Impellers listed include an impeller seal.

The SRZ-CD-14/19A, SRZ-CD-15/21A and SRZ-CD-16/21A are a new, updated version to work on all years and has a thicker blade surface for added strength for the newer, higher horsepower units.



SOLAS BILLET IMPELLER SEAL

Fits Solas Concord and Skat Trak 3-Blade Super Pro impellers.

Description	Part No.
Solas Aluminum Billet Impeller Seal	SLA012



SKAT TRAK IMPELLERS FOR SEA-DOO PWC

3-Blade Swirl Super Pro Impeller 159-83-28
Skat Trak recommends:

Model	Year	Stock	Limited	Modified
GTR 215	12-15	13/18	-----	-----
RXT 215	05-10	13/17	13/18	-----
RXT 260	11-15	14/19	14/20	-----
RXT iS 255	09	13/18	14/19	-----
RXTaS 260	11	14/19	14/20	-----
RXTiS 260	10-12	13/18	14/19	-----
RXT-X 255	08-10	13/18	14/19	-----
RXT-X 260	11-15	14/19	14/20	-----
RXT-XaS 260	12-15	14/19	14/20	15/20
RXP 155	07-08	13/17.5	13/18	-----
RXP 215	04-10	13/18	14/19	-----
RXP-X 255	08-11	14/19	14/20	-----
RXP-X 260	10-13	14/19	14/20	-----

Skat Trak Impellers do not include a seal.
Hot Products recommends SLA012 sold separately.
OEM rubber shaft-impeller seal also fits.

159-83-28 3-Blade Swirl Super Pro

Description	Part. No.
13/17 3-Blade Swirl Super Pro	SS598328SW31317
13/18 3-Blade Swirl Super Pro	SS598328SW31318
14/19 3-Blade Swirl Super Pro	SS598328SW31419
14/20 3-Blade Swirl Super Pro	SS598328SW31420
15/18 3-Blade Swirl Super Pro	SS598328SW31518
15/19 3-Blade Swirl Super Pro	SS598328SW31519
15/20 3-Blade Swirl Super Pro	SS598328SW31520
15.5/21.5 3-Blade Swirl Super Pro	SS598328SW3155215
Aluminum Billet Impeller Seal for 3-Blade Super Pro	SLA012



RIVA R-SERIES PUMP IMPELLERS

NOTE: R-Series Impellers must be used with RIVA's Pro-Series Reduction Nozzle (Part# RS23050-N for RXP/RXP-X) or (Part# RS23051-N for RXT)



iBR Models	Year(s)	Stage 1	Stage 2	Stage 3	Stage 4
RXP-X 260 (iBR)	2012-13	OEM	SRZ-CD-15/19R	SRZ-CD-15/19R	SRZ-CD-15/19R
RXT-X 260 (iBR)	2011-13	SRZ-CD-15/20R	SRZ-CD-15/19R	SRZ-CD-15/19R	SRZ-CD-15/19R
RXT 260 (iBR)	2011-13	SRZ-CD-15/20R	SRZ-CD-15/19R	SRZ-CD-15/19R	SRZ-CD-15/19R
RXT-X aS 260 (iBR)	2011-13	SRZ-CD-15/20R	SRZ-CD-15/19R	SRZ-CD-15/19R	SRZ-CD-15/19R
RXT iS 260 (iBR)	2011-12	SRZ-CD-15/20R	SRZ-CD-15/19R	SRZ-CD-15/19R	SRZ-CD-15/19R
GTX Ltd iS 260 (iBR)	2011-13	SRZ-CD-15/20R	SRZ-CD-15/19R	SRZ-CD-15/19R	SRZ-CD-15/19R
RXT-X 260 (iBR)	2010	SRZ-CD-15/22R	SRZ-CD-15/19R*	SRZ-CD-15/19R*	SRZ-CD-15/19R
RXT iS 260 (iBR)	2010	SRZ-CD-15/22R	SRZ-CD-15/19R*	SRZ-CD-15/19R*	SRZ-CD-15/19R
RXT iS 255 (iBR)	2009	OEM	SRZ-CD-15/19R*	SRZ-CD-15/19R*	SRZ-CD-15/19R
non-iBR Models	Year(s)	Stage 1	Stage 2	Stage 3	Stage 4
RXP-X 255	2008-11	SRX-CD-15/22R**	N/A	N/A	N/A
RXT-X 255	2008-09	SRX-CD-15/22R**	N/A	N/A	N/A
RXP 215	2004-10	SRX-CD-15/19R	SRX-CD-15/20R	SP-MP-159-15/19R**	N/A
RXT 215	2005-10	SRX-CD-14/17R	SRX-CD-13/19R	SP-MP-159-15/18R**	N/A
GTX 215	2005-08	SRX-CD-14/17R	SRX-CD-13/19R	SP-MP-159-15/18R**	N/A
GTX 185 SC	2003-06	SR-CD-13/20R	N/A	N/A	N/A

* Requires 2011 Spec OEM Reduction Nozzle (Part #267000502)

** Requires RIVA Pro Series Reduction Nozzle (Part #RS23050-N)

SEA-DOO
4 STROKE

INTAKE
SYSTEMS

ENGINE/
GASKETS

EXHAUST

DRIVE LINE
HANDLING

ELECTRICAL

WATERLINE
/BLIGE

STEERING
& CONTROLS

BODY

ACCESSORIES
SERVICE TOOLS

/HARDWARE

CHEMICAL



R&D FX-SHO/SVHO/ FZR/FZS PRO COMP COOL AIR FILTER KIT

The system is designed and tested with boost levels above 23 pounds and speeds of 92+ MPH. The R&D System utilizes an oversized specifically designed 7.25" x 5.5" x 6" teardrop shaped R&D Power Plenum Filter w/crankcase vent that rubber mounts in the space over the top left side of the gas tank. The system ducts its air supply to the supercharger via an "Indy Car style" 3.5" mandrel bent Aluminum tube and couples to the supercharger with a 90° Nomex tapered reduction elbow. Power Plenum Filters generate the maximum airflow and volume and install in minutes. Recommended for the R&D C1, C3, C5 and C20X Monster Supercharger Wheel kits and Superchargers.



RY13040

RIVA PERFORMANCE YAMAHA FX-SHO/FZR/FZS POWER FILTER KIT

The RIVA Power Filter feeds your FX-SHO, FZS or FZR a steady diet of cool air delivering greatly improved acceleration and rpm. Replaces restrictive stock air box with a high-volume, precision-formed intake duct that attaches to the supercharger via a large 4" adapter. Cool air enters the system via an oversized K&N filter element. Includes water-repellent pre-filter.



200-01803



200-01804

Description	Part No.
FX-SHO (2008-11), FZR/FZS (2009-14) Pro Comp Cool Air Filter Kit (3")	200-01802
FX-SHO (2008-11), FZR/FZS (2009-14) Pro Comp Cool Air Filter Kit (4")	200-01803
FX SVHO (2014-15), FX SHO (2012-13) Pro Comp Cool Air Filter Kit (3")	200-01804

Description	Part No.
FX-SHO (2008-11)/FZR/FZS (2009-12)/FZ SVHO	RY13040
FX-SHO (2012-13)/FX SVHO (2014)	RY13070
RIVA Power Filter Only (for RY13040 & RY13070)	RK13090-2



RIVA VXR/VXS POWER FILTER KIT

Key Features:

- Delivers increased acceleration & top speed
- True "cold air" system utilizes OEM hood scoop
- Ultra-dry water trap keeps water out of system
- Genuine screen type K&N Flame Arrestor & water repellent prefilter cover
- Large 4" smooth-bore ducting attaches to engine via flow-matched velocity stack
- Includes updated crankcase breather system for improved performance

Description	Part No.
VXR/VXS (2008-11), FX HO (2008-11)	RY13061
VXR/VXS (2012-15)	RY13062



R&D VXR/VXS POWER PLENUM FILTER KIT

The R&D High Performance Power Plenum Air Filter Kit was designed and developed exclusively for the new Yamaha 1.8 liter N/A engine. The R&D filter kit will unleash low-end, mid-range, and peak horsepower trapped in the restrictive stock air box. The exclusive lightweight filter design couples to the OEM throttle body through a tuned built in velocity stack. The engineered oversized Tear Drop plenum, delivers the velocity and cubic air volume needed to add power. Power Plenum Filters generate the maximum airflow and volume.

Description	Part No.
VXR/VXS (2011-14)	200-01805



R&D FX-SHO/ FX-SVHO/FZR/FZS POWER PLENUM FLAME ARRESTER FOR STOCK AIR BOX

The R&D High Flow Filter design replaces the restrictive stock filter inside the stock air box, allowing improved air flow. Why? Because more air flow means more power and improved performance. The washable and reusable design means this will be the last filter you will ever have to buy.

Description	Part No.
FX-SHO (2008-12), FX-SVHO (2013-14), FZR/FZS (2009-14), VXR/VXS (2011-14)	200-01800



RIVA YAMAHA SVHO/SHO/HO REPLACEMENT PERFORMANCE AIR FILTER

Description	Part No.
SVHO/SHO/HO	RY13040-OE



OEM



R&D



INTERCOOLER
CFM SPACER



INTAKE MANIFOLD
POWER SLEEVE

R&D FX-SHO/SVHO/FZR/FZS POWER CORE INTAKE MANIFOLD/INTERCOOLER CFM KIT

The R&D FX-SHO/FZR/FZS Power Intake Manifold and Intercooler CFM Kit was developed to increase airflow into and through the intake system by relieving restrictions. The R&D FX-SHO/FZR/FZS intake manifold ribbon remover sleeve will unlock a 40 CFM (cubic feet per minute) air flow restriction by replacing the intake manifold ribbon with the R&D billet venturi sleeve. The R&D Intercooler Spacer will unlock a 30-35 CFM restriction in the intercooler. The R&D FX-SHO/FZR/FZS Intake Kit will add low end and mid range throttle response, and a full 100 plus rpms to top end performance to a stock FX-SHO/FZR/FZS. The R&D FX-SHO/FZR/FZS Intake Kit is an absolute must have parts kit to remove intake restrictions before contemplating power adding compressor booster wheels or turbo charger kits to the FX-SHO/FZR/FZS engine. True horsepower gains on the FX-SHO/FZR/FZS start right here with the R&D Intake Kit. More airflow will equal more power, and there is no other way around the fact that restricted is restricted power.

Description	Part No.
FX-SHO (2008-12), FZR/FZS (2009-12) Power Core Billet Intake Manifold Sleeve & Intercooler Spacer CFM Kit	612-18000
FX-SHO (2008-12), FZR/FZS (2009-12) Power Core Intake Manifold Sleeve Only	612-17998
FX-SHO (2008-12), FZR/FZS (2009-12) Intercooler CFM Spacer Only	612-17999
VXR/VXS (2011-12) Power Sleeve	232-18000
Intake Manifold Upgrade Kit	
SVHO (2013-14), VXR/VXS (2013-14)	612-17997
Power Sleeve Intake Manifold Upgrade Kit	



RESTRICTIVE
STOCK
FILTER



PRECISION
TAPERED
INSERT

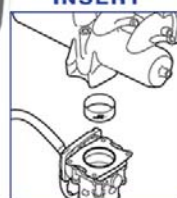
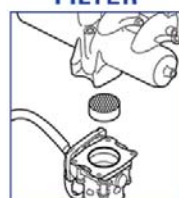

RIVA FX-SHO/FZR/FZS INTAKE MANIFOLD UPGRADE KIT

RIVA's Intake Manifold Upgrade Kit enables your engine to produce more horsepower by delivering increased air flow and boost pressure (+1lb). Precision tapered billet sleeve directly replaces restrictive mesh element in the intake manifold. Provides improved low end punch and mid range pull through a quick & easy installation. Includes detailed installation instructions. *NOTE: Testing has determined the stock ECU will compensate for the increased boost provided by our Intake Manifold Upgrade Kit.*

Description	Part No.
FX-SHO & FZ Models, 2013 VXR/VXS & FX-HO Models	RY12040-IMUK

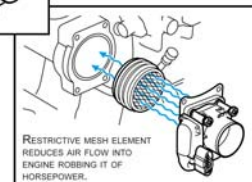
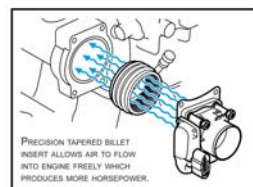

RIVA YAMAHA 1.8L N/A ENGINE INTAKE MANIFOLD UPGRADE KIT

IJSBA Stock Class Legal.

Description	Part No.
2009-12 1.8 HO (Naturally Aspirated) Models Only	RY12055-IMUK

YAMAHA FX-SHO/SVHO/FZ • SUPERCHARGER



R&D SVHO-FX (2014-15), SVHO-FZR (2014-15) MONSTER CHARGER WHEEL



Description	Part No.
2014 SVHO FX-FZR Watercooled s/c Housing Only (OEM Replacement)	612-24002
2014 SVHO C1 Monster Charger Wheel Kit (10 lbs.)	612-24010
2014 SVHO C3 Monster Charger Wheel Kit (13-14 lbs.)	612-24013
2014 SVHO C5 Monster Charger Wheel Kit (16 lbs.)	612-24015
2014 SVHO C17X Monster Charger Wheel Kit (17 lbs.)	612-24017

R&D FX-SHO (2008-13), FZR (2009-13) MONSTER CHARGER WHEEL



Description	Part No.
2008-13 SHO/FZR C1 Monster Charger Wheel Kit (10 lbs.)	612-25001
2008-13 SHO/FZR C3 Monster Charger Wheel Kit (13 lbs.)	612-25003

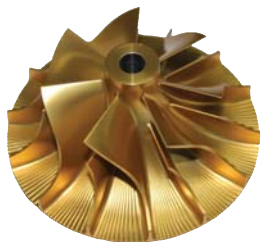

FX SVHO HIGH BOOST

Description	Part No.
FX SVHO High Boost 17 lbs. Wheel	ETYAMSVHO17
FX SVHO High Boost 19 lbs. Wheel	ETYAMSVHO19

NEW

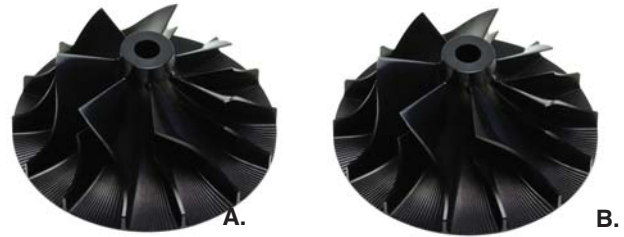

RIVA YAMAHA FZ & FX SVHO SUPERCHARGER IMPELLERS

Description	Part No.
A. F1 Impeller	RY17080-SCI-F1
B. F2 Impeller	RY17080-SCI-F2

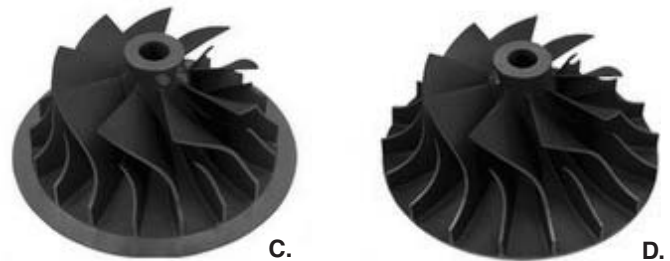

RIVA FX-SHO (2008-13), FZR (2009-13) SUPERCHARGER IMPELLERS

NOTE: Both impellers require use of aftermarket engine management system for proper calibration (See page 47).

Description	Part No.
C. RIVA FX-SHO/FZR S/C Impeller - 11.5 psi	RY17040-SCI-B1
D. RIVA FX-SHO/FZR S/C Impeller - 16 psi	RY17040-SCI-E1



R&D SPECIALTY SUPERCHARGER TOOLS

R&D has designed custom tools that are essential in the rebuilding process of the Yamaha Supercharger. All tools are specific in application and are CNC machined to ensure a precision job.

Description	Part No.
E. R&D Supercharger Housing Holder Bracket Tool	612-92010
F. R&D Shaft/Gear Holding Tool	612-92011

YAMAHA FX-SHO/SVHO/FZ • SUPERCHARGER



R&D YAMAHA SHO/SVHO/FZR BILLET SUPERCHARGER SHAFT KIT

R&D's new High Performance Billet Supercharger Shaft eliminates the weak design features of the OEM and aftermarket HKS supercharger shafts. After analyzing the OEM HKS shaft design and sorting through the various failures we had with it while testing our popular Monster S/C Wheels, we developed a superior shaft design. The new R&D shaft is not a copy of the fragile HKS design. Rather, it is a completely new design, superior in material strength and improved in every way. The new R&D Shaft is precision CNC machined, heat treated, and precision ground from billet steel alloy. Featuring a uni-structure design that incorporates the shaft and gear as one billet piece, much like a transmission shaft. This eliminates the fracture point on the OEM design where the gear shears off the end of the shaft. The billet design will not allow the gear to slip under high boost loads like the pressed on OEM gear.

Next R&D increased the inadequate 6mm thread diameter on the OEM shaft to utilize a well proven "Turbo spec" LARGER 5/16-24 left handed thread that will not break under extreme conditions. The larger thread diameter will also allow wheel torque specs to be increased safely.

Lastly, R&D reduced the weight of the R&D Supercharger shaft by eliminating the hex nut on rear the gear and lightened the end of the shaft/gear inside diameter to significantly reduce reciprocating weight. We all know what that will do to add to clutch performance. Kit comes complete with larger nut and installation instructions. All in all, the new R&D High Performance Billet Racing Shaft is not just a replacement shaft, but a solution to end all supercharger shaft problems.

Description	Part No.
R&D FX-SHO/FZR Billet Supercharger Shaft Kit	612-25020

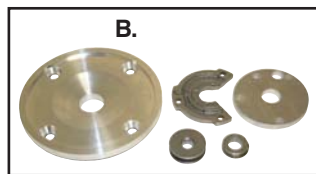
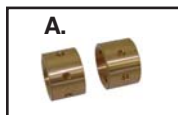

R&D FX-SHO/FX-SVHO/FZR HIGH PERFORMANCE SUPERCHARGER REPLACEMENT THRUST BEARING/SEAL KITS & DUPLEX BEARING KIT

R&D offers an answer to both repairing & upgrading the OEM superchargers vulnerable thrust bearing and main shaft bearing assemblies. Engines with superchargers running higher boost pressures and higher rpm frequencies will eventually need bearing servicing. Servicing the supercharger main bearings periodically or upgrading to R&D's new "Duplex Bearing System" will extend the life of the superchargers thrust bearing significantly. R&D offers both standard replacement bearing kits, and the new "Duplex Bearing Kit" that will work in any Yamaha supercharger. R&D also offers complete rebuild kits for stock superchargers running C1 Monster Wheel Kits and all supercharger wheel kits using the stock exducer size. R&D also offers rebuild kits for all C3, C5, C7 Monster Wheel Kits with larger exducers.

Description	Part No.
A. R&D OEM Replacement Bearing Kit (stock/ltd class legal)	612-25025
B. R&D Supercharger Rebuild Kit with OEM Exducer/Thrust Bearing Assembly Kit	612-25028
B. R&D Supercharger Rebuild Kit with C3/C5 Exducer/Thrust Bearing Assembly Kit	612-25030



R&D SUPERCHARGER CLUTCH REMOVAL TOOL



This R&D tool enables the clutch to be changed in a matter of only minutes. With the supercharger and front engine cover removed the tool drops down through the case and secures the drive gear at the front of the crankshaft from rotating when the clutch is removed and installed. This is a "must have" tool that will save massive amounts of time for any mechanic.

Description	Part No.
R&D FX-SHO/FX-SVHO/FZR Supercharger Clutch Removal Tool	612-92012

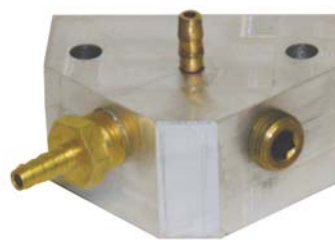

R&D FX-SHO/FZR/FZS MULTI-PRESSURE PORT BOOST GAUGE/SURGE/RRFPR ADAPTER KIT

The R&D Yamaha FX-SHO/FZR/FZS Multi-Pressure Port Adapter Kit will allow quick and easy hook up of digital or manual boost gauges with the R&D Multi-port billet Adapter. The R&D Pressure Port Adapter installs between the MAP sensor and the MAP sensor bracket as a "bolt on" part no with modifications. Operate a vacuum/boost gauge, check plenum air temperatures, and operate a surge protection valve at the same time, or run a boost gauge, surge protection device, and operate a boost referenced fuel pressure regulator (RRFPR) at the same time with one simple part. The R&D Pressure Port Adapter Kit comes complete with longer MAP sensor mounting screws, o-ring seals, nylon cable ties, all mounting hardware and instruction.

Description	Part No.
R&D (2008-10) FX-SHO/FZR/FZS Multi-Pressure Port Boost Gauge/Surge/RRFPR Adapter Kit	612-92005



R&D FRONT ENGINE COVER GASKET

R&D's new Front Cover Gasket features a metal reinforced center that enables it to be reusable when servicing the supercharger clutch.

Description	Part No.
R&D FX-SHO/FZR/VXR/VXS Front Engine Cover Gasket	080-21024

4 STROKE	YAMAHA
SYSTEMS	INTAKE
GASKETS	ENGINE/
	EXHAUST
	DRIVE LINE
	ELECTRICAL
	WATERLINE
	STEERING
	BODY
	ACCESSORIES
	SERVICE TOOLS
	CHEMICAL

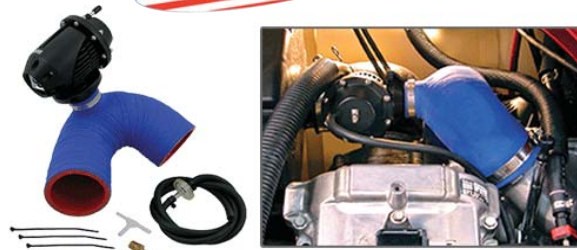

RIVA FX-SHO/FZR/SVHO PERFORMANCE BLOW-OFF VALVE KIT

RIVA Performance Blow-off Valve Kit improves supercharger reliability and performance by relieving unwanted pressure during off-throttle operation. Reduces supercharger clutch & gear wear and eliminates heat soak in discharge tube. High-strength silicone hose with integrated HKS valve installs easily in place of OEM elbow joint. Includes high quality HKS Super SQV (Super Sequential Blow Off Valve) that features unique sequential valve structure and a differential pressure control system, allowing for a broad operation boost range. Also includes vacuum line and fittings necessary for installation on FX-SHO engine. A simple and cost effective upgrade for both stock and modified engines.

Description	Part No.
RIVA FX-SHO/FZR/SVHO Performance Blow-off Valve Kit	RY17040-BV

R&D/TIAL 50MM SURGE/ BLOW-OFF VALVE KIT

R&D announces the release of the new R&D/Tial 50mm Surge/Blow-off Valve Kit. R&D has been committed to on going research for any part that proves to be an aid in reducing the inherent and well known clutch issues related to running high performance boost wheels and high boost pressures in the Yamaha 1.8 Supercharged engine. R&D has noticed a significant reduction in clutch related issues in high boost ranges by "Going Big". R&D engineers have concluded through endurance testing that the new 50mm R&D/Tial Valve with its huge 50mm lightweight billet aluminum piston, and 6 massive (bigger than any other valve) pressure relief ports, to outperform the smaller (25-35mm) HKS Sequential, and



35mm Greddy RZ Valves. The trick R&D has found with this valve is, in aggressive off throttle situations with a gear driven supercharger the big Tial 50mm piston responds quickly to allow the reduction of boost pressure which relieves back pressure that can affect the clutch. The new 50mm design also has a much larger diaphragm over HKS and Greddy, which helps the piston react quicker to relieve pressure. If you are running Boost Wheels that produce over 15 pounds of boost, R&D strongly suggests looking into a larger valve setup. It only stands to reason that with higher boost pressures, a larger valve can allow quicker discharge of air volume. Valve kit comes complete with Aluminum weld-on adaptor, o-ring seal, billet Aluminum V-clamp, and banjo style vacuum fitting.

- Aggressive throttle response, increased horsepower from a better seal
- Increased boost pressures over smaller valves that don't seal well
- Improved valve action with larger diaphragm and variable spring control
- Improved clutch performance from reduced off throttle back pressures
- Precision sequential valve operation
- Installs easy and clean to the OEM intercooler inlet/outlet
- Works well on R&D Pro Series Intercoolers

Description	Part No.
A. R&D/Tial 50mm BOV Valve Only	613-95263
R&D/Tial 50mm BOV Valve Only (With 10 pound spring) for SVHO	613-95264
B. R&D/Tial 50mm BOV Kit	612-18009
R&D/Tial 50mm BOV Kit (With 10 pound spring) for SVHO	612-18010

WORX YAMAHA BLOW OFF VALVE ASSEMBLY



- WORX cost effective design BOV will greatly improve supercharger clutch life in your Yamaha 1.8 engine. Kit includes a high strength silicone hose that incorporates a billet lightweight "blow off valve", necessary vacuum lines and fittings for install
- Easy to install to OEM location

- Lightweight billet construction less load on hose to reduce fatigue and tearing
- Easy to disassemble for cleaning and maintenance
- Cost effective upgrade for stock or modified skis

Description	Part No.
WORX Yamaha Blow Off Valve Assembly	WR04021

R&D 2011 FZR, FX-SVHO MULTI-PRESSURE PORT BOOST GAUGE SURGE - RRFPR ADAPTOR KIT



The R&D Yamaha FZR/SVHO Multi-Pressure Port Adaptor Kit will allow quick and easy hook up of a manual boost gauge, surge valve, and a raising rate fuel pressure regulator. The R&D Pressure Port Adaptor installs in the MAP sensor hose and has 3 ports that allow for the operation of a vacuum/boost gauge, check plenum air temperatures, operate a surge protection valve, and operate a boost referenced fuel pressure regulator (RRFPR), or any three of these applications at the same time with one simple part. The R&D Pressure Port Adaptor Kit comes complete with 12" of vacuum hose, multi-line fitting, 2 tube covers, nylon cable ties and instructions.

Description	Part No.
R&D 2011 FZR, FX-SVHO Multi-Pressure Port Boost Gauge Surge - RRFPR Adaptor Kit	612-92006

YAMAHA 4 STROKE
INTAKE SYSTEMS
ENGINE/GASKETS
EXHAUST
DRIVE LINE HANDLING
ELECTRICAL
WATERLINE /BILGE
STEERING & CONTROLS
BODY
SERVICE TOOLS ACCESSORIES /HARDWARE
CHEMICAL

YAMAHA FX-SHO/SVHO/FZ • INTERCOOLER



RIVA 'GEN-2' POWER COOLER KIT

The RIVA 'GEN-2' Power Cooler intercooler system features a new high-capacity cooler element that is rated for up to 500hp! Huge cooler core resists heat soak under the most demanding high boost/high temperature applications. Delivers an increase of 20 peak horsepower over OEM intercooler providing arm-wrenching results on the water. Quality manufacturing of cooler core delivers minimal pressure drops and excellent thermal efficiency. The cooling element is dramatically more efficient than the stock unit with exit temperatures averaging 60°F cooler than stock. This delivers cooler, denser air for increased performance throughout the RPM range. Innovative design allows easy disassembly of cooler element & ducting for maintenance and cleaning. Features integrated blow-off valve mount that will accept RIVA/HKS Blow-Off Valve kit (sold separately) for improved supercharger reliability and performance. Power Cooler installs securely with shock absorbing rubber mounting system and stainless steel hardware. Kit contains all necessary hardware and detailed installation instructions.

Key Features Include:

- Large cooler element rated for 500hp.
- Designed to allow easy disassembly of cooler element & ducting for cleaning.
- Integrated mount for optional RIVA/HKS Blow-Off Valve Kit (sold separately).
- Includes billet "high flow" pump strainer providing a dedicated waterline to Power Cooler.
- Replaceable sacrificial zinc anodes protect cooler element from corrosion.
- Quick release flushing system keeps Power Cooler at peak performance.

Note: Power Cooler requires use of one of the following components:

- RIVA FX-SHO/FZ Power Cooler Blow-off Valve Kit (part# RY17040-BOV-SSQV)
- RIVA Blow-off Valve Block-off Kit (part# RY17040-BVBO-SSQV)

Description	Part No.
RIVA 'Gen-2' Power Cooler Kit FX-SHO/FZ	RY17040-PC-1
RIVA FX SVHO/FZR/FZS SVHO Power Cooler Kit	RY17080-PC
RIVA Pro Series SVHO Engine Cooling Upgrade Kit (See page 46)	RY10080-ECUK-PC
RIVA Universal Filter Kit	RY1013-SDF-UK



R&D SVHO-FX/FZ PRO SERIES RACING INTERCOOLER KIT

- Significantly improves cooling efficiency
- Flows 90-100 CFM more than stock (allows 60 pounds of unrestricted air)
- Bolts directly into stock air box location w/OEM studs and rubber grommet hardware
- Increases overall horsepower (core size/area allows up to 600 horsepower)
- Aggressive holeshot and mid-range acceleration
- Works great with any R&D Monster compressor wheels
- Retains OEM flushing system for maintenance
- IJSBA and APBA Limited Class and Pro Open legal

Description	Part No.
SVHO-FX/FZ	612-18005



R&D FX-SHO/FZR STAGE 1 INTERCOOLER CORE KIT

- Flows 40 CFM more than stock
- 3 pounds lighter than stock
- Improves cooling efficiency
- Bolts directly into stock location
- Increases horsepower by reducing restrictions
- Works great with C1 compressor wheel
- Retains OEM flushing system for maintenance

Description	Part No.
R&D FX-SHO/FZR/FZS Stage 1 Intercooler Core Kit	612-18001



WORX YAMAHA 1.8L INTERCOOLER KIT

- Huge internal core element for increased air flow and denser air
- Extremely lower air intake temps over OEM cooler
- Huge horsepower gains, up to 45+ horsepower in certain applications
- Removable bracket, silicone hoses and necessary hardware all INCLUDED for easy install
- Upright element and water flow for increased heat transfer and efficiency
- Upright mounting allows water to completely drain from unit after use
- Blow off valve INCLUDED in kit to help supercharger reliability and performance
- Complete engine/intercooler kit upgrade INCLUDED for lower engine and air temps

Description	Part No.
Yamaha 1.8 L Engine	WR01007

YAMAHA	4 STROKE
INTAKE SYSTEMS	
ENGINE/GASKETS	
EXHAUST	
DRIVE LINE HANDLING	
ELECTRICAL	
WATERLINE /BLGGE	
STEERING & CONTROLS	
BODY	
ACCESSORIES	
SERVICE TOOLS /HARDWARE	
CHEMICAL	



RIVA PRO SERIES SVHO ENGINE COOLING UPGRADE KIT

Key Features:

- Improved performance & reliability
- Allows use of aftermarket ECUs & high boost compressor wheels
- High-flow billet pump strainer increases water flow
- Billet fitting injects water into "hot spot" of engine block
- Retains benefits of OEM thermostat
- Includes detailed installation instructions

NOTE: Fits Yamaha FZR/FZS SVHO & FX SVHO models. Designed for use with RIVA SVHO Power Cooler (part #RY17080-PC)

Description	Part No.
RIVA SVHO Engine Cooling Upgrade Kit	RY10080-ECUK-PC



RIVA STAGE 1 SVHO ENGINE COOLING UPGRADE KIT

- Improved performance & reliability
- Quick and easy to install
- Features specially-sized drill bits and clamps
- Includes detailed installation instruction

NOTE: Fits Yamaha FZR/FZS SVHO & FX SVHO models only

Description	Part No.
RIVA SVHO Stage 1 Engine Cooling Upgrade Kit	RY10080-ECUK-1



R&D YAMAHA FX-SHO/FZR ENGINE INTERCOOLER COOLING KIT

The R&D Yamaha FX-SHO/FZR Engine/Intercooler Cooling Kit was developed for **high performance recreational and racing use**. Extensive engine cooling and inlet air temperature testing using both MoTeC I2 and Innovate digital logging systems has proven the R&D High Performance Cooling Kit to offer double the water volume flow through the engine, oil cooler, and intercooler as well as increase water pressure. The OEM cooling system has a very low water pressure (10 P.S.I. at 7600 RPMs) and a low water volume flow. **The new R&D kit will double the water volume which will lower intake air temperature by 15-20 degrees as well as lower engine block and head temperatures by 40-50 degrees. The additional oil cooler water line will lower engine oil temperatures by 15-20 degrees promoting better lubrication and increased engine cooling.** The R&D Cooling Kit arrives 100 percent complete with pre-cut hoses, "T" connectors, dual line pump block, through hull bulkhead fittings, hose clamps, water by-pass fittings, the thermostat removal sealing washer, and detailed instructions with pictures. R&D recommends the cooling system to be upgraded as a stand alone performance upgrade and a must have kit addition when installing power adders such as R&D Supercharger Wheels, Engine Performance Parts, and Engine Management Kit parts. Cooler engine, inlet air, and oil temperatures produce higher horsepower with decrease detonation

- Better throttle response, increased horsepower
- Cooler header and under seat temperatures
- Increased power with cooler air inlet temperatures
- Cooler cylinder and cylinder head will reduce knock
- Cooler oil will lubricate better and last longer
- Increased engine protection
- Improved clutch performance with cooler oil

Description	Part No.
FZR/FZS Engine/Intercooler Cooling Kit	660-18001
SVHO/FZR Racing Engine/Intercooler Cooling Kit	660-18002
SVHO FX/FZR Rec Engine/Intercooler Cooling Kit	660-18003



R&D INTERCOOLER TEMPERATURE CONTROL PRESSURE RELIEF VALVE KIT

R&D also offers a pressure relief blowoff valve kit for high water volume flow rates on higher boost Stage 1 and up engine kits. The R&D kit will allow temperature

tuning that will deliver surprising results. Unlock hidden performance and power potential in the OEM stock intercooler or aftermarket intercooler system by reducing intercooler core temperatures.

Description	Part No.
Yamaha All 1.8L Engines	660-82511



R&D RECREATIONAL ENGINE COOLING KIT FOR YAMAHA 1.8L ENGINES

The R&D Yamaha 1.8L Recreational Engine Cooling Kits were developed for recreational and offshore racing uses.

Extensive engine cooling temperature testing and digital data logging has proven R&D Cooling Kits offer increased water volume flow through the engine, oil cooler, and intercooler, as well as increased water pressure. The OEM Yamaha cooling system has a very low water pressure (10 PSI at 7600 RPMs) and a low water volume flow. The new R&D single line addition kit will lower engine block and intake air temperature by 15-20 degrees. Kit comes with pictorial instructions. The kit works on all 2008+ year model Wave Runners with the 1.8L supercharged or naturally aspirated engine.

Description	Part No.
Yamaha 1.8L Engine Recreation Engine Cooling Kit	660-18006



WORX YAMAHA 1.8 ENGINE COOLING PLATE

WORX new Yamaha engine block cooling plate allows for up to 3 fittings to be installed for maximum water flow into your Yamaha 1.8 engine block. Injection points target engine hot spots and direct initial cooling around the #2 cylinder, which is common for detonation and overheating in high boost applications.

- Billet anodized construction allows 1-3 fittings to be installed
- Fits all 1.8L Yamaha engines (may require OEM o-ring for early models, o-ring not included)
- Allows for maximum cooling to engine under high boost
- Race proven in closed course and endurance

Description

Yamaha 1.8L Engines

Part No.

WR04032



A.



B.



INTERCOOLER/SUPERCHARGER LUBRICATION KIT

This kit will allow you to spray a aerosol lubricant of your choice into the supercharger, intercooler and throttle body to prevent rust from the excess moisture in the system. Complete instructions, pictures and a diagram supplied for a simple installation.

Description

A. Yamaha/Sea-Doo Spray
Nozzle Inlet for Lubrication

B. Replacement Plug for Nozzle Inlet Kit

Part No.

IWCS-SSU

IWCS-SU-P



ENGINE BLOCK THERMOSTAT KIT COOLING OPTION

The R&D Block Thermostat Kit Option was developed to offer a way to run "Dual Thermostats" to the engines cooling system to control and allow warm up and pre heat cycles to take place. Engine Block and Head cooling on the Yamaha Engine becomes difficult when running high compression ratios, higher boost levels, and aggressively advanced ignition timing. R&D has found that multiple cooling lines need to be added to the cooling system to provide enough volume to keep temperatures stable and in check. The problem is the Single OEM thermostat is too restrictive and doesn't allow enough water volume flow to reduce temperatures with the added cooling lines. R&D has found a way to add an additional thermostat that allows enough water flow volume to cool the engine and head and retain the OEM method for engine pre heat or warm up. The R&D Kit installs as a bolt on kit directly in place of the corrosion anode. Running two thermostats allows enough water flow to cool the engine properly. The R&D thermostat kit option will start to open at 120 degrees, and will allow full flow at 140 degrees. The OEM stock thermostat opens at 118-126 degrees and allows full flow at 140 degrees. Having two thermostats installed that are full open at 140 degrees, and flow enough water volume, will help to keep engine block temperatures to between an ideal 150-175 degrees. R&D has done extensive testing with the engineers at MoTeC both on the Dyno and on the water to determine that 150-160 degrees block temperatures is where the most peak power is, any hotter and power diminishes. The R&D dual thermostat kit will be a must have addition where engines are being run in extreme cold water and weather conditions.

Description

R&D SHO/FZR/FZS/VXR/VXS, SVHO-FX/FZ

Part No.

660-18004



RIVA YAMAHA 1.8L THERMOSTAT DELETE KIT

Allows Yamaha SVHO, SHO & HO engines to run cooler by replacing the thermostat with a specialized restrictor. Ideal for modified watercraft operating in high air & water temperatures. Designed to be used with RIVA Engine Cooling Upgrade Kits. Precision machined restrictor includes o-ring system for superior sealing in thermostat housing. includes complete installation instructions.

Description

SVHO/SHO/HO

Part No.

RY1013-40-TR

YAMAHA
4 STROKE

INTAKE
SYSTEMS

ENGINE/
GASKETS

EXHAUST

DRIVE LINE
HANDLING

ELECTRICAL

WATERLINE
/BILGE

STEERING
& CONTROLS

BODY

ACCESSORIES

SERVICE TOOLS
/HARDWARE

CHEMICAL



RIVA REAR EXHAUST KIT

RIVA Racing Rear Exhaust Kit delivers performance and cutting-edge style. Allows for removal of restrictive sound suppression system located between waterbox and hull exit. Improves engine performance by reducing back pressure and restriction. Includes mandrel bent aluminum exhaust tube that is powder coated to prevent corrosion, large billet through-hull exhaust outlet, billet OEM exhaust outlet block-off and high-temp silicone couplers along with all necessary mounting hardware & installation.

Description	Part No.
FZR/FZS/FZ SVHO	RY15050
VXR/VXS (2011-14)	RY15060
VXR/VXS (2015-16)	RY15061
FX-SHO/FX-HO (NA) 2012 & Newer/ FX SVHO (2014)	RY15070



RIVA FX SHO/FZR FREE FLOW EXHAUST KIT

Replaces the restrictive sound suppression system located between the water box and hull exit on your watercraft. Improves engine performance by reducing back pressure and harmful detonation. Includes mandrel bent aluminum tubing that is powder coated to prevent corrosion, high-temp silicone replacement coupler and installation instructions.

Description	Part No.
A. RIVA FX-SHO(2008-11) FZR/FZS/FZ-SVHO Free Flow Exhaust Kit	RY16040
B. RIVA 2012 & Newer FX-SHO & FX HO (NA) FX-SVHO Free Flow Exhaust Kit	RY16070
RIVA VXR/VXS Free Flow Exhaust Kit	RY16060



RIVA FX-SHO/FZ PRO-SERIES WATER BOX

Developed on RIVA's Dyno and tested extensively on the water, this water box features radiused exhaust tubes and end caps for optimum exhaust flow. Unique exhaust baffle will increase the low-end power and mid-range pull of your Yamaha watercraft. Delivers up to 15hp on modified engines along with significant torque gains. High-strength aluminum construction will survive backfires and meltdowns. Powder coated to prevent corrosion.

A must for all modified motors.

Key Features:

- Delivers up to 15hp on modified craft!
- Machined hose flanges for reliable coupler retention.
- Radiused exhaust tubes & end caps.
- Powder coated to prevent corrosion.

Description	Part No.
RIVA FX-SHO (08-12)/FZ/FX SVHO/FZ SVHO Pro Series Water Box	RY16041



R&D EXHAUST RESONATOR REMOVAL KIT



The R&D Exhaust Resonator Removal Kit will allow the sound suppression ball to be removed and plugged. When removing the exhaust sound suppression ball and modifying the exhaust hose, low end response is gained

and trapped hot exhaust gases can be evacuated quicker through less restriction or back pressure.

Description	Part No.
R&D VXR/VXS Exhaust Resonator Removal Kit	332-18005



R&D FX-SHO/FZR/FZS HIGH FLOW EXHAUST KIT

The R&D SHO High Flow Exhaust Kit will add a noticeable low end and mid range power feel as well as add top end performance! The R&D High Flow Exhaust Kit will add a great performance sound to the SHO while maintaining a safe and under IJSBA and Coast Guard approved 86 db!

Description	Part No.
RIVA FX-SHO (08-11)/FZR/FZS High Flow Exhaust Kit	332-18000

R&D FX-SHO/SVHO/ FZR/FZS/VXR/VXS FUEL PRESSURE REGULATOR KIT



R&D offers a Yamaha FX-SHO/FZR/FZS/VXR/VXS model specific fuel pressure

regulator system allowing custom fuel pressure tuning to the EFI fuel systems fuel pressures. The R&D Fuel Pressure Regulator System offers a wide range of setup possibilities. Base fuel pressure is adjustable from 5 to 60 PSI. The R&D fuel pressure regulator can also be set up to allow "rising rate" fuel pressure at a 1 to 1 ratio (One pound of fuel pressure gain over base for every pound of boost gain). R&D offers two types of fuel pressure regulator set ups. Part #802-00080 will come completely assembled and ready to install. The R&D Pro System is 100 percent complete, installs directly to the top of the fuel tank, and connects directly to the fuel rail with OEM security lock connectors with no modifications. For the R&D Fuel Pressure Regulator only use part #801-25010, which comes complete with 90 degree barbed brass fittings for use with push on type hose and Oetiker style clamps for security. R&D offers high performance fuel hose that can be purchased by the foot, as well as the Oetiker style clamps. The R&D bypass style regulator system is capable of handling any fuel pump up to 250 GPH. Replace "Deadhead" regulator performance and experience the full flow volume and rock steady fuel pressure that only a dynamic R&D fuel pressure regulator kit can produce.

- Fuel pressure will rise on a 1:1 ratio when boost referenced
- All ports are 3/8" NPT, with one inlet, 3 outlets, and one return port on the bottom
- Beautiful type II bright dip anodized finish
- Bypass design produces the ultimate, dynamic fuel delivery system
- 3/8" pipe tapped for standard or AN fitting ready
- R&D offers pre-assembled #4 AN hose to finish off a return system
- R&D offers fuel hose by the foot for custom routing

Description	Part No.
R&D FX-SHO/FX-SVHO/FZR/FZS/VXR/VXS Fuel Pressure Regulator Kit (Shown above)	802-00080
R&D Universal Fuel Pressure Regulator Only (Fittings not included)	801-25010

R&D-FX SHO/FZR/VXR/VXS IN-TANK FUEL PRESSURE REGULATOR BLOCK OFF KIT



R&D offers a Fuel Pressure Regulator Block off Kit which will allow the OEM stock in tank fuel pressure regulator to be removed, blocked off, and replaced with a billet part which is mandatory when installing an after-

market externally adjustable fuel pressure regulator system. The OEM in tank fuel pressure regulator is fixed to maintain 40-43 pounds of fuel pressure at all times. For high performance applications where horsepower is boosted, it is necessary to install larger flowing fuel injectors and be able to tune the fuel pressure up or down as needed. Most factory race teams are running 65 plus pounds of fuel pressure along with higher flowing fuel injectors and externally adjustable pressure regulators. The R&D has a complete line up of fuel pumps, fuel injectors, fuel pressure regulators, fuel gauge, and fuel hose accessories all designed specifically for the Yamaha SHO. All R&D fuel injection parts and products meet Coast Guard, IJSBA, and APBA approval.

Description	Part No.
R&D FX-SHO/FZR/FZS/VXR/VXS In-Tank OEM Fuel Pressure Regulator Block Off Kit	812-35257



RIVA FX-SHO/FZ RISING RATE FUEL PRESSURE REGULATOR KIT

RIVA Fuel Pressure Regulator Kit provides the precision pressure control necessary to compliment aftermarket ECU applications on the 'SHO' engine. Kit is fully assembled & mounts securely on top of fuel tank via sturdy aluminum bracket. High quality billet pressure regulator can adjust base pressure from 25 to 80 PSI. Unit can also be set up as rising rate fuel pressure

regulator at a 1 to 1 ratio providing one additional pound of fuel pressure for every pound of boost gain. Plugs directly into original fuel system with OEM connectors and features a large 3/8" fuel return line that is routed through supplied rubber fuel tank cap. Includes integrated liquid-filled pressure gauge and billet Fuel Pressure Regulator Block-Off necessary for removal of stock fuel pressure regulator in fuel tank.

Key Features Include:

- Precision fuel pressure control with optional rising rate function.
- High quality stainless steel liquid-filled pressure gage.
- Large 3/8" fuel return line.
- Includes billet Fuel Pressure Regulator Block-Off.
- Easy bolt-on installation with OEM fuel connectors.
- Includes complete installation instructions & tuning guide.

Description	Part No.
RIVA Fuel Pressure Regulator Kit 2008-11 FX-SHO, All FZR/FZS, FZ SVHO	RY12040-RRFPR-6S5
RIVA Fuel Pressure Regulator Kit 2012 & Newer FX-SHO Models, FX SVHO	RY12070-RRFPR-6S5

R&D INLINE FUEL PRESSURE GAUGE ADAPTER



The R&D Fuel Pressure Gauge Adapter Tool is designed to be a plug in fuel pressure gauge that needs no modifications to install and use. Simply disconnect the OEM locking fuel connector from the fuel

rail and plug the gauge tool directly into the connector. Plug the locking connector supplied on the R&D tool onto the fuel rail and lock. Use the tool to verify fuel pressure and fuel pump condition. Use the tool to set and verify base fuel pressure settings on the R&D Rising Rate Fuel Pressure Regulator (RRFPR). When finished, disconnect the tool and reconnect the stock fuel line. The Adapter installs inline between the OEM fuel rail and the R&D RRFPR via the OEM connectors for easy connect and disconnect. The R&D Tool works on both Yamaha and Kawasaki fuel systems. Installation time is only 2 minutes. Liquid filled fuel pressure gauge sold separately.

Description	Part No.
R&D Inline Fuel Pressure Gauge Adapter	612-00081
R&D Liquid Filled Fuel Pressure Gauge	900-02180

4 STROKE	YAMAHA
INTAKE SYSTEMS	
ENGINE/GASKETS	
EXHAUST	
DRIVE LINE HANDLING	
ELECTRICAL	
WATERLINE /BLGGE	
STEERING & CONTROLS	
BODY	
ACCESSORIES	
SERVICE TOOLS /HARDWARE	
CHEMICAL	

YAMAHA 4 STROKE
INTAKE SYSTEMS
ENGINE/GASKETS
EXHAUST
DRIVE LINE HANDLING
ELECTRICAL
WATERLINE /BILGE
STEERING & CONTROLS
BODY
SERVICE TOOLS ACCESSORIES
SERVICE TOOLS ACCESSORIES /HARDWARE
CHEMICAL

WORX YAMAHA 1.8L FUEL PRESSURE REGULATOR



- In-tank replacement increases fuel pressure by approximately 10 psi
- Cost effective alternative to external fuel regulator
- Ideal for low boost applications and reflashed/aftermarket ECU

Description Yamaha 1.8L Engines **Part No.** WR04025



RIVA YAM 1.8L BOOST CLAMP



NOTE: Not intended for use with RIVA/Vi-PEC ECU

Description YAM 1.8L Boost Clamp 2011+ **Part No.** RY11740-BC-6BH
YAM 1.8L Boost Clamp 2008-10 **Part No.** RY11740-BC-6S5



RIVA HIGH FLOW BILLET FUEL RAIL

Key Features:

- High flow fuel delivery supports more power
- Fits all Yamaha OEM injectors along with RIVA 100 lb. Pro-Series Fuel Injectors (part #RY12040-I-KIT-100)
- Accepts OEM Yamaha fuel connector fitting for easy installation
- Delivers equal fuel supply to injectors with flow-through fuel routing
- Billet aluminum construction and anodized to prevent corrosion
- Can also be used on stock engine with stock injectors for cosmetic upgrade

Applications: All Yamaha 1.8 liter engines (SVHO, SHO, HO)

Description Yamaha 1.8L High Flow Billet Fuel Rail **Part No.** RY12040-BFR



WSM OEM REPLACEMENT FUEL PUMP

OEM #60E-13907-00-00, 60E-13907-01-00, 60E-13907-02-00

Description FX 1000 (2002-08), FX 1100 (2005-08), VX 1100 (2005-12), GP 1300 (2002-08) **Part No.** 004-815



RIVA PRO-SERIES YAMAHA FUEL INJECTORS

RIVA's high impedance fuel injector kit delivers additional fuel to modified engines for high boost applications. **100lb (1,000cc)** injectors are for use with aftermarket ECU for correct calibration. Kit includes four injectors, plug and play adapters, fuel rail spacers and detailed installation instructions. Fits 2009-12 FX-SHO & FZ models.

Description RIVA Pro-Series Yamaha Fuel Injectors **Part No.** RY12040-I-KIT-100

O2 SENSOR MOUNTING KIT



- CNC construction from billet aluminum
- Directly replaces stock tail pipe section
- Retains original temperature sensor
- Accepts Bosch O2 sensor (not included)
- Includes o2 sensor tool & block-off plug
- Anodized to prevent corrosion

Description Yamaha 1.8L Models **Part No.** RY15040-TP-O2

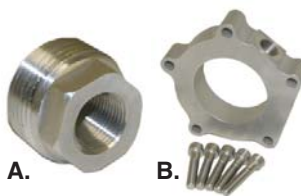

R&D FX-SHO/FZR/FZS O2 SENSOR MOUNT KIT

The new R&D O2 sensor mount kit makes installing an AFR gauge a breeze on the Yamaha FX-SHO, FZR, FZS, FX140, HO, GPR, and VX110. It simply replaces the OEM plug and installs directly into the OEM pipe without any modifications. Kit comes complete with installation tool. AFR gauge sold separately.

Description A. FX-SHO Pre 2012/ FZR/FZS/FX140/HO/GPR/VX110/VXR/VXS O2 Sensor Mount Kit **Part No.** 332-18010
B. FX-SHO 2012+/ FZR/SHO/FXHO/FX-SVHO/VXR/VXS O2 Sensor Adaptor **Part No.** 332-18009

YAMAHA FX-SHO/SVHO/FZ/VXR/VXS • FUEL SYSTEM



R&D HIGH PERFORMANCE ECU REPROGRAMMING SERVICES

SVHO FX/FZR/FZS 6EV/6ET ECU	Rev Limit	Part No.
R1 (91 Octane/76-78mph)	8250rpm	802-00611
R2 (91 Octane/78-80mph)	8550rpm	802-00612
R3 (91 Octane/80+mph)	8650rpm	802-00613
R4 (95 Octane/80+mph)	8850rpm	802-00614
Offshore (91 Octane)	9000rpm	802-00615
Pro Stock 100 (100 Octane/83-85mph)	8650rpm	802-00616

ECU reflashing is recommended for competition use only.



RIVA SPEED CONTROL OVERRIDE MODULE FOR SVHO-FZR/FZS



- Removes restrictive speed limiter system
- Increases top speed utilizing stock ECU
- Delivers 3-4 MPH with no additional modifications
- Allows further top speed gains through aftermarket modifications
- All original dash functions are retained
- Does not interfere with the speedometer functionality
- Easy plug-in installation

NOTE: 2014 Yamaha SVHO models do not have factory speed control function and do not require this module modifications.

Description	Part No.
SVHO-FZR/FZS Speed Control Override Module	RY11080-SCOM



RIVA FX SHO/FZ 3 BAR MAP SENSOR KIT

Do you plan on running over 14.7psi of boost? If so, RIVA's 3 Bar MAP Sensor Kit is essential for accurate engine management with high boost applications. High quality 3 Bar MAP Sensor

will measure up to 29.7psi, where the OEM 2 Bar MAP Sensor will only measure up to 14.7psi. It is critical to provide accurate pressure information to your aftermarket ECU to ensure proper air/fuel mixture and data logging. RIVA 3 Bar MAP Sensor mounts directly in place of OEM sensor with stainless bracket and plugs directly into OEM wiring harness.

Description	Part No.
RIVA FX-SHO 2008-10/FZ 3 Bar Map Sensor Kit	RY11740-MS-3
RIVA FX-SHO 2011 & Newer 3 Bar Map Sensor Kit	RY11741-MS-3-11



Scan QR Code to find option of Dash Logger extension cable mount.

RIVA/VI-PEC V88R3 PRO SERIES ECU

The RIVA/Vi-Pec V88R Pro Series ECU provides a huge performance advantage to the Yamaha 1.8L engine delivering over 50hp to the stock SHO engine. ECU is fully programmable with either RIVA supplied mapping or user defined parameters. Most calibrations require use of RIVA Fuel Pressure Regulator Kit and 91+ octane pump fuel. Plugs directly into factory wiring harness via waterproof connectors.

Key Features Include:

- 1) Easy loading of supplied calibrations/maps for various performance applications.
 - Performance Fuel Mapping
 - Performance Timing Curves
 - Rev Limiter Increase
 - Boost Control for turbo applications. (Plug & play connector for wastegate solenoid).
- 2) Ability to customize RIVA calibrations for special applications. Using supplied software, user can adjust parameters such as Fuel, Timing, Rev Limiter & Boost Control.
- 3) Retains all OEM dash display functions & Engine Safety Functions.
- 4) Internal Data logging functionality.
- 5) Provides diagnostic information that can be displayed via computer interface.
- 6) Includes plug & play connector for RIVA Dash/Logger unit (RY11840-LD-MD60)
- 7) Includes plug & play connector for optional lambda sensor kit (part# RY11540-LC1-6S5) for data logging air/fuel ratios & tuning functions.
- 8) Direct-Connect design eliminates need for auxiliary wiring harness.
- 9) Individual Cylinder Knock Control function. Identifies which cylinder is detonating by tracking firing order utilizing OEM knock sensor.
- 10) User selectable dual calibration capacity for optional Dual Map Switch (part # RY11841-DMS-ECU-PC).
- 11) Expansion Port for additional user definable inputs & outputs.
- 12) User configurable software.

NOTE: RIVA Pro-Series ECU is for competition use only.

* RY11840-ECU-DC-1 is compatible with SVHO

Description	Part No.
Yamaha 1.8L Models	RY11840-ECU-DC-1

YAMAHA
4 STROKE

INTAKE
SYSTEMS

ENGINE/
GASKETS

EXHAUST

DRIVE LINE
HANDLING

ELECTRICAL

WATERLINE
/BILGE

STEERING
& CONTROLS

BODY

ACCESSORIES

SERVICE TOOLS
/HARDWARE

CHEMICAL

YAMAHA FX-SHO/FX-SVHO/FZ/VXR/VXS • ENGINE



JE PISTON KITS FOR YAMAHA FX SHO 1800 (2009-13)

PISTON KIT #	DISP.	BORE SIZE	OVER SIZE	COMP. RATIO	RING #	SLEEVE SURFACE
289959	1812cc	86mm	STD	8.6:1	JG1004-3386	Deglaze Only
292314	1812cc	86mm	STD	9.5:1	JG1004-3386	Deglaze Only
308631	1812cc	86mm	STD	10.5:1	JG1004-3386	Deglaze Only
308632	1812cc	86mm	STD	11.0:1	JG1004-3386	Deglaze Only
308633	1832cc	86.5mm	+5mm	8.6:1	JG1004-3405	Bore & Hone
308634	1832cc	86.5mm	+5mm	9.5:1	JG1004-3405	Bore & Hone
308635	1832cc	86.5mm	+5mm	10.5:1	JG1004-3405	Bore & Hone
308636	1832cc	86.5mm	+5mm	11.0:1	JG1004-3405	Bore & Hone

*Sold as Kit (4 pistons per kit)

**Piston sold complete with: rings, piston pin and locks



CP PISTON KITS FOR YAMAHA FX SHO (2008-12)

PISTON KIT	DESCRIPTION	RING #
M1077A	86mm Standard Bore (1812cc) 2008-12 Yamaha FX SHO 8.6:1 Turbo	CPN-3386
M1078A	86mm Standard Bore (1812cc) 2008-12 Yamaha FX SHO 9.5:1 Turbo	CPN-3386
M1081A	86mm Standard Bore (1812cc) 2008-12 Yamaha FX SHO 10.5:1 Turbo	CPN-3386
Oversize Pistons		
M1082A	86.5mm .5mm oversize (1834cc) 2008-12 Yamaha FX SHO 8.6:1 Turbo	CPN-3406
M1083A	86.5mm .5mm oversize (1834cc) 2008-12 Yamaha FX SHO 9.5:1 Turbo	CPN-3406
M1084A	86.5mm .5mm oversize (1834cc) 2008-12 Yamaha FX SHO 10.5:1 Turbo	CPN-3406
Stock Bore: 3.386 (86mm)		

*Sold as Kit (4 pistons per kit)

**Piston sold complete with: rings, piston pin and locks



WISECO PISTON KITS FOR YAMAHA

Yamaha Model	Years	Bore x Stroke (mm)	Piston Kit Number	Replacement Ring Set	Pins & Clips
FX Cruiser HO	2008-10	86.00	40049M08600*	8600XX	Wrist Pin S734
FX SHO	2009-11	x			Circlips W5590
FZR	2009-12	78			
FZS	2009-12				
FX Cruiser SHO	2008-11				
FX HO	2008-10				

Displacement 1812.7cc • 8.6:1 Compression Supercharged
11.1 Compression Non-supercharged • ArmorGlide™ Skirt Coated
Piston sold complete with: rings, piston pin and circlips.

*Sold individually



FZR HIGH PERFORMANCE RACING CYLINDER SLEEVES YAMAHA 1.8L ENGINE

R&D High Performance Racing Sleeves are made to precise specifications specific for the Yamaha FZR/SHO Supercharged engine. R&D Racing Sleeves install easily and properly using the flanged "top hang" register design. The "top hang" design when installed and seated properly will not drop or slip which will allow 100 percent head gasket contact for a positive head gasket seal. R&D Racing Sleeves are manufactured from the highest grades of centrifugally cast "Molly 2000" Chrome Molly Iron Alloy to provide superior strength and hardness. Trouble free installation, boring, and honing using kit supplied installation instructions and tips on final hone specifications for OEM cast and R&D Forged Racing Piston Kits are included. When the time comes to repair wavy, scored, seized, or worn cylinders trust the pros at R&D. R&D has been re-sleeving race engines for over 40 years. *Sleeves are sold individually.*

Description	Part No.
R&D SHO/SVHO/FZR High Performance Racing Cylinder Sleeves	432-18000
R&D LA Sleeve Yamaha 1.8L Engine Cylinder Sleeve	YA-5688
R&D FZR/SHO/SVHO/VXR/VXS 88mm Big Bore Sleeve (Sold Individually)	432-18088

RIVA/DARTON YAMAHA 1.8L PRO-SERIES CYLINDER SLEEVES



RIVA's new bulletproof sleeve system is the ultimate foundation for your high performance engine. Engineered specifically for the Yamaha SHO engine by Darton Sleeves, the leader in racing sleeve technology, these sleeves will hold up to extreme punishment in high boost applications. Innovative "Flat-Lock" flange design locks sleeves in place reinforcing block and protecting head gasket.

Key Features Include:

- Integrated Flat-Lock flange design protects block.
- Bulletproof Darton ductile steel construction.
- Increased horsepower potential.
- Ideal for high boost supercharged & turbo applications.
- Superior ring sealing.
- Can be installed by your local machine shop.

Description	Part No.
RIVA/Darton Yamaha 1.8L Pro-Series Cylinder Sleeves (Sold 4 sleeves per set)	RY10040-SLV-470

NGK SPECIAL SPARK PLUGS FOR FOUR STROKE ENGINES



Description	Part No.
Yamaha FX SHO/FX Cruiser, SHO/FZR/FZS (10 plugs per box) Solid Tip Plug	LFR6A
Yamaha FX SVHO (10 plugs per box)	LFR7A

YAMAHA FX-SHO/FZ/VXR/VXS • ENGINE



CARRILLO CONNECTING RODS

Description Carrillo Connecting Rod Set Yamaha 1.8L 4 cylinder (sold 4 rods per set)
Part No. YA-FXSHO>-9M5709S-04



RIVA PRO-SERIES 4-STROKE CYLINDER HEAD STUD KITS

Key Benefits Include:

- Superior material & heat treat process provide 10X better fatigue strength than OEM bolts.
- Studs provide improved alignment of cylinder head and gasket for increased reliability and ease of maintenance.
- More accurate & consistent torque loading provides a more uniform clamping force on head gasket.
- Helps prevent blown head gaskets and assures optimum engine sealing.

Description RIVA Pro-Series Cylinder Head Stud Kits FX-SHO/FZR/FZS
Part No. RY10040-HSK



RIVA FLYWHEEL BOLT UPGRADE KIT

High strength bolt kit directly replaces OEM flywheel bolts that are prone to shearing off on modified Sea-Doo 1503cc and Yamaha 1.8 liter engines. Superior materials and design improve durability and reliability. A must for endurance, closed course and HydroDrag race craft! Sold as a set of 6.

Description Flywheel Bolt Upgrade Kit
Part No. RY10840-FWB



RIVA CRANKCASE REPAIR THRUST PLATE

RIVA's Crankcase Repair Thrust Plate provides a cost-efficient repair option for damaged Yamaha 1.8 liter engine cases. This item can save your expensive engine cases after failures due to:

- Driveline coupler loosening
- PTO transfer shaft loosening
- Nut on end driveshaft loosening

These failures can push the crankshaft forward and damage the thrust plate area inside the crankcase. As a result, the crankcase needs to be repaired or replaced. Our specially designed bronze bushing requires machining of damaged crankcase for installation. We recommend working with a qualified machinist due to the tight tolerances that must be kept.

Description SVHO/SO/HO
Part No. RY10040-TB-OIB125



RIVA YAMAHA HIGH PERFORMANCE VALVE SET

Drop-In Valve Kits: Standard size drop-in direct replacement valves require no machining of cylinder head.

Oversized Valve Kits: +1mm Intake/+1mm Exhaust valves deliver more air flow (requires machining of cylinder head).

Key Features:

- Stronger & lighter than stock valves.
- Redesigned valve heads for improved air flow & strength.
- High grade stainless intake valves resist corrosion.
- Inconel exhaust valves resist heat from high boost applications.
- Valve stems are hard-chrome plated for improved wear.
- Includes high strength valve locks.
- Sold in sets of 16 (8 Intake/8 Exhaust).

Description RIVA Yamaha High Performance Valve Set (Standard/Drop-in)
Part No. RY19040-HPV-0
 RIVA Yamaha High Performance Valve Set (+1mm Intake / +1mm Exhaust)
Part No. RY19040-HPV-1:1



RIVA VALVE TRAIN UPGRADE KIT

RIVA's Valve Train Upgrade Kits increase the reliability of your modified engine by reducing the possibility of valve float at high rpm. Includes lightweight, precision-machined titanium valve retainers, racing valve springs, and base washers.

Description RIVA FX-SHO/FZR/FZS/SVHO Valve Train Upgrade Kit (Sold in sets of 16)
Part No. RY19040-VTU-2



RIVA VALVE COMPRESSION TOOL

RIVA's overhead Valve Compression Tool allows easy removal of valve springs and keepers without removing cylinder head. Includes compression adapter to pressurize cylinder keeping valves in place during removal of stock springs and keepers. Fits both Yamaha 1.8L & Kawasaki 1.5L 4-stroke engines.

Description RIVA Valve Compression Tool Fits Yamaha 1.8L & Kawasaki 1.5L 4-stroke
Part No. RY19040-VCT

4 STROKE	YAMAHA
SYSTEMS	INTAKE
GASKETS	ENGINE/
	EXHAUST
HANDLING	DRIVE LINE
ELECTRICAL	
WATERLINE	
/BLIGE	
& CONTROLS	STEERING
BODY	
ACCESSORIES	
SERVICE TOOLS	
/HARDWARE	
CHEMICAL	

YAMAHA FX-SHO/SVHO/FZ/VXR/VXS • ENGINE

YAMAHA 4 STROKE
INTAKE SYSTEMS
ENGINE/GASKETS
EXHAUST
DRIVE LINE HANDLING
ELECTRICAL
WATERLINE /BILGE
STEERING & CONTROLS
BODY
SERVICE TOOLS ACCESSORIES
/HARDWARE
CHEMICAL



R&D DUAL & SINGLE VALVE SPRINGS/RETAINERS/CUP KIT

Description	Part No.
A. Dual Valve Spring Racing Kit (Stock/limited legal) (Set of 16)	612-93001
B. Dual Valve Shim Kit .010" Thickness (Set of 16)	612-93003
B. Dual Valve Shim Kit .020" Thickness (Set of 16)	612-93004
B. Dual Valve Shim Kit .030" Thickness (Set of 16)	612-93005
C. Bottom Spring Retaining Cups (For dual springs) (Set of 16)	612-93006
D. Replacement Valve Stem Seal Kit (Set of 16)	612-93007



R&D FZR TITANIUM RETAINER KIT

OEM Replacement for FZR stock class legal.

Description	Part No.
FZR Titanium Retainer Kit	612-94016
Super Single Valve Spring/Titanium Retainer/Cup Kit (Set of 16)	612-94000



RIVA YAMAHA 1.8L ENGINE PERFORMANCE VALVE SEALS

RIVA's high quality viton seals are extremely resistant to heat and abrasion. Superior sealing keeps unwanted oil from contaminating combustion chambers and prevents air leakage through valve guides. A precision seal removal & installation tool (RY19040-VST) is available separately.

Description	Part No.
RIVA Yamaha 1.8L Engine Performance Valve Seals (Sold in sets of 16.)	RY19040-PVS-1



RIVA YAMAHA 1.8L ENGINE VALVE RETAINER UPGRADE KIT

RIVA's Valve Retainer

Upgrade Kit increases the reliability of your engine by reducing the possibility of valve float at high rpm. Includes 16 lightweight, precision-machined titanium valve retainers. A must for IJSBA & APBA Stock Class race craft.

NOTE: For modified engines (Stage 3 & above) we recommend the complete RIVA Valve Train Upgrade Kit (part # RY19040-VTU).

Description	Part No.
RIVA Yamaha 1.8L Engine Valve Retainer Upgrade Kit (Sold in sets of 16)	RY19040-SRU-1



RIVA YAMAHA 1.8L ENGINE VALVE SEAL TOOL

This handy tool provides easy removal and installation of valve stem seals on Yamaha 1.8L engines. Allows seal installation during fitting of valve train upgrade kit without removing cylinder head.

Key features:

- Prevents seal distortion & gouging.
- Precision machined from 6061 aluminum & anodized.
- Knurled handle for positive grip.

Description	Part No.
RIVA Yamaha 1.8L Engine Valve Seal Tool	RY19040-VST



RIVA PRO-SERIES 4-STROKE CYLINDER HEAD GASKETS

Key Benefits Include:

- Three layer stainless construction for durability & corrosion resistance.
- Viton coated & embossed surfaces for maximum sealing between head and cylinder block.
- Unique design promotes even torque load across sealing surface & requires no re-torque.

Description	Part No.
RIVA Pro-Series Head Gasket (Standard Bore) FX-SHO/FZR/FZS	RY10040-CHG-86



R&D SHO/FZR/VXR/VXS HIGH PERFORMANCE RACING HEAD GASKET

Bore Size	Part No.
86mm	080-01800
86.5mm	080-01801
87mm	080-01802
87.5mm	080-01803
88mm	080-01804
88.5mm	080-01805
89mm	080-01806
89.5mm	080-01807
90mm	080-01808
Specify*	080-01810
*Super Thin Head Gasket" 0.18" 2 layer *Must Specify bore size	

NOTE: No need to re-torque the head bolts after initial installation which is a big plus on DOHC engines where cams would otherwise need to be removed. Head torque specifications are included with each gasket.



R&D YAMAHA FZ/FZR/SHO/SVHO PRO TUNE ADJUSTABLE CAM GEAR KIT

R&D's Racing Cam Gear kit allows a huge boost in overall horsepower to be gained by custom tuning the camshafts LCA (lobe separation angle) set up. Tuning the LCA with R&D Pro Tune Cam Gears can add 200-300 RPMs, increased boost pressure, and 2-3 MPH to your existing engine package. Adjusting the camshafts LCA is a very simple "BOLT IN" modification with the R&D Pro Tune Adjustable Cam Gear Kit. Understanding the LCA concept principle is fairly easy. A wide LCA like found in the SHO and FZR will generally result in decreased valve overlap, later intake events, earlier exhaust events, and high intake manifold pressures which produce great idle, smooth accelerating with mild low and top end power. Wide LCAs are great for school buses and soccer mom vans. However, if strong mid range pull and top end horsepower is what you're looking for, then a narrower LCA will need to be generated. The R&D Pro Tune Cam Gear Kit allows the LCA (lobe separation) to be adjusted narrower which will generate increased valve overlap, earlier intake events, and later exhaust events. Resulting in snappier throttle response, increased mid range and top end power and more boost. Why spend big money on optional camshaft kits (i.e. 1800 N/A cams) that have proven to offer too narrow of LCA compromising idle tune? Buy the R&D Pro Tune Cam Gears designed specifically to improve overall power at a fraction of the cost and provide an optimum overall tune. The R&D Cam Gear Kit offers four possible LCA combinations that allow the cams to be tuned depending on the type of riding or racing and type of fuel. In fact, R&D has built a specific engine designated for degreasing, checking and proving camshaft specifications. Depend on the Pros at R&D to deliver all your horsepower needs.

- Aggressive throttle response, increased overall horsepower
- Increased rpm performance (+200-300 RPM Gain)
- Boost Pressure Increase (+1 pound)
- 15-25 Horsepower Increase
- Precision CNC Billet/Ground Cam Gears (lighter than stock)
- R&D R1, R2, and R3 ECU Compatible
- Works well with R&D Cam Regrind and Valve Spring Kit upgrades
- Easy installation
- Bolt on Higher Horsepower Upgrade

NOTE: R&D has determined that the OEM LCA is a WIDE 120 degrees stock, with an intake cam lobe center of 122.5 degrees. Considering the LCA timing facts, using the R&D Pro Tune Cam Gears to tune the cams will generate huge performance power gains. R&D has found in testing that a 2.5 degree LCA change will act similar to a 1 pound boost addition. Tests have proven that an R&D C1 or C3 compressor wheel and a 7 degree LCA change can have the same performance advantages as a 15 pound compressor wheel. Call R&D for constant power upgrade information as we are constantly at work looking for more.

Description	Part No.
FZ/FZR/SHO (2008-12)	612-93018
FZ/FZR/SHO/SVHO (2013-15)	612-93019
FZ/FZR/SHO/SVHO (2016)	612-93020



RIVA YAMAHA 1.8L ENGINE ADJUSTABLE CAM SPROCKET KIT

Adjustable Cam Sprocket Kit delivers a significant increase in horsepower, speed & RPM through easy cam timing adjustment. RIVA's 'Quick-Tune' design features color coded timing inserts that lock-in desired cam adjustment in minutes without removal of cam tensioner, camshaft or cam sprocket (after initial installation). Design allows fast & easy timing adjustment; saving hours of time when testing and tuning. Sprockets are precision machined from billet steel and heat treated for maximum durability.

Key Features Include:

- Allows fast & easy adjustment of cam timing for maximum performance.
- Quick-Tune timing inserts lock-in cam timing in minutes.
- Designed for both SHO & HO Yamaha 1.8L engines.
- Works well with both stock and performance cams.
- Easy bolt-on installation.
- Includes complete instructions with tuning guide.

Description	Part No.
RIVA Yamaha 1.8L Engine (2013-15) Adjustable Cam Sprocket Kit	RY19040-ACS-1



Description	Part No.
R&D FZR Cam Tensioner Tool	612-92015

FZR CAM TENSIONER TOOL

The R&D Cam Tensioner Tool is designed to mechanically spring preload the cam chain in order to set and verify cam timing. This eliminates the process of pressurizing the hydraulic cam tensioner to verify cam timing.



Description	Part No.
R&D Cam Tensioner Gasket	080-21025

R&D CAM TENSIONER GASKET

R&D's new Cam Tensioner Gasket has a metal reinforced center that enables it to be reusable.

4 STROKE	YAMAHA
SYSTEMS	INTAKE
GASKETS	ENGINE/
	EXHAUST
HANDLING	DRIVE LINE
ELECTRICAL	
WATERLINE	/BILGE
STEERING	& CONTROLS
BODY	
ACCESSORIES	SERVICE TOOLS
	/HARDWARE
CHEMICAL	



R&D AQUAVEIN INTAKE GRATE

RIVA TOP-LOADER INTAKE GRATES

Description	Part No.
FX-SHO/FX Cruiser Super High Output (2008-11)	112-18000
FZR/FZS (2009-13)	112-18001
FX HO (2012+)/FX Cruiser HO/ FX SHO (2012+), FX SVHO	112-18010
VXR/VXS (2009-13)	112-18020
VXR/VXS Pro2	112-18021
FZR/FZS 2014	112-18004

Description	Part No.
FZR/FZS (2009-13) <i>Stainless Steel</i>	RY22050-1
RIVA FX-SHO (2008-11) FX Cruiser	RY22040
FX-SHO/SVHO (2012-15)	RY22070
FZ SVHO (2014-16)	RY22051



FZ SVHO - RY25051

RIVA PUMP SEAL KITS

Dramatically reduce cavitation and prop spin with our easy to install Pump Seal Kits. Location specific, molded inserts fill the voids in OEM pump inlet shoe that bleed air into pump causing cavitation. Recommended for modified craft using aftermarket intake grates. Includes detailed installation instructions.

Model	Intake Grate	Pump Seal Kit
FX-SHO (2008-11)	RY22040	RY25040
FZR/FZS (2009-13)	RY22050-1	RY25050-1
FX-SHO/SVHO (2012-15)	RY22070	RY25070
FZ SVHO (2014-16)	RY22051	RY25051



R&D PUMP SEAL KIT

R&D's new pump seal kit stuffs up all the unwanted cavities in the pump shoe that aid in producing cavitation. This kit offers a way to seal the pump shoe, which will reduce cavitation and increase pump efficiency and performance.

Model	Intake Grate	Pump Seal Kit
FX SHO/FX Cruiser SHO (2008-11)	OEM	162-00003
FX SHO/FX Cruiser SHO (2008-11)	RY22040	162-00004
FX SHO/FX Cruiser SHO (2008-11)	112-18000	162-00005
FZR/FZS (2009-13)	OEM	162-00006
FZR/FZS (2009-13)	112-18001	162-00007
VXR/VXS (2009-13)	OEM	162-00008
VXR/VXS (2009-13)	112-18020	162-00009
FX HO2012+)/FX Cruiser HO	112-18010	162-00010
FX SHO (2012+) FX SVHO		
FX HO (2012+)/FX Cruiser HO	OEM	162-00011
FX SHO (2012+) FX SVHO		
FZR/FZS (2014)	OEM	162-00014
FZR/FZS (2014)	112-18004	162-00015



WR232



WR233



WR240



WR237



WR245

WORX RACING INTAKE GRATES

Description	Part No.
FX SHO (2008-11)	WR232
FZS/FZR (2009-13)	WR233
FX/FX SHO (2012-14)	WR237
VX Series	WR239
VXR/VXS	WR240
FZR/FZS S2 (2014)	WR241
FZ SVHO (2014+)	WR245

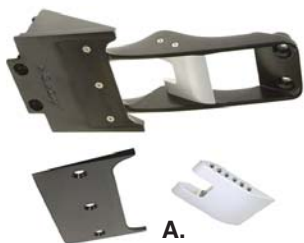

A.



B.

TBM RACING FZR/FZS SUPER SCOOP

Description	Part No.
A. FZR/FZS (2009-13) "Tunable" Super Scoop	TBM100-FZR
B. FZR/FZS (2004-15) Super Scoop	TBM100-FZR-2

NEW



RIVA FZR/S AND VXR/VXS BILLET BACKING PLATE KIT

Description	Part No.
RIVA Billet Backing Plate Kit	NEW RY21050-BPK-RI



WR313

WORX RACING RIDE PLATE

Description	Part No.
FZR/FZS	WR313
FZR/FZS REC	WR316



FX SHO
122-18000



122-18001 & 122-18004

R&D PRO SERIES RIDE PLATE

Description	Part No.
R&D FX SHO, FX Cruiser SHO (2008-11)	122-18000
R&D FZR/FZS (2009-14) Pro Series Ride Plate	122-18001
R&D VXR/VXS Pro Series Ride Plate	122-18004



RY21050

RIVA PERFORMANCE RIDE PLATE

Description	Part No.
RIVA FX-SHO (2008-11)	RY21040
RIVA FZR/FZS (2009-14)	RY21050

YAMAHA
4 STROKE

INTAKE
SYSTEMS

ENGINE/
GASKETS

EXHAUST
HANDLING

DRIVE LINE
HANDLING

ELECTRICAL
/BILGE

WATERLINE
& CONTROLS

STEERING
/BODY

BODY
ACCESSORIES

SERVICE TOOLS
/HARDWARE

CHEMICAL



R&D YAMAHA FX-SHO/FZR/FZS SPONSON KIT

The new R&D Yamaha SHO Pro Series Sponson Kit was designed and developed with all new generation performance concepts in mind to deliver a whole new level of handling and speed performance with offshore and closed course race proven adjustability options. The R&D Pro Series Sponson Kits have been extensively offshore, race track, and 1 and 2 up recreational tested to guarantee a comfortable setting for any riding style or condition! The R&D Sponson Kit will deliver higher top speed performance and a much smoother and more predictable ride over OEM sponsons. Low speed and high-speed turns are a breeze with new found control. The secret to R&D's new generation concept is in the backing plate design with an aftermarket first, low pressure, low friction concept that breaks up and relieves speed robbing drag within the sponson's backing plate channel. The new R&D design staggers the sponson blades fins water trapping area to pick up less water in the front and more in the back. The stagger/step-up concept greatly reduces chine walk in high speed corners, while allowing more rear end grip. There is also a higher end recreational/race setting with enough grip for the best of pros! Finally there is an aftermarket sponson kit that really does it all! More top speed due to less drag, less chine walking, racer preferred rear end grip, and unmatched straight line stability.

Description	Part No.
FX SHO, FX SHO Cruiser	122-01800
FZR/FZS (2009-13)	122-01801
FZR/FZS (2014)	122-01804
VXR/VXS	122-01820
FX HO 2012/FX SHO 2012/ FX Cruiser HO 2012, FX SVHO 2014	122-01799



R&D SPONSON EXTENDER

The new R&D Yamaha FZR Sponson Extender is designed to widen the nose of the sponson. This kit retrofits any R&D FZR/SHO Sponson Kit. The widened sponson improves cornering, handling and high speed stability. Machined from billet aluminum and black anodized for corrosion resistance.

Description	Part No.
R&D FZR/FZS/VXR/VXS/SHO (2004-12) FX SVHO Sponson Extender	122-01802



RY2625



RY26070

RIVA YAMAHA FX-SHO/VX SPONSON KIT

Unique blade design provides a significant improvement to the handling characteristics. Reduces rough water hunting and rolling sometimes experienced with stock sponsons. Sponson depth is adjustable to control the amount of influence they have on craft. Easily installs to stock mounting points with our bulletproof mounting system that features billet inserts in sponson fins.

Description	Part No.
FX-SHO (2008-11), VXR/VXS (2011-14), VX110 (2004-13)	RY2625
FZ SVHO (2014-16), FX SVHO (2014-16) FX SHO (2012-16), FX HO (2012-16)	RY26070



WORX RACING YAMAHA SHO/FZR/FZS SPONSONS

Fitting Worx sponsons provide unbelievable cornering, better control in the rough and predictable inline tracking while towing wakeboards or waterskiers. Worx sponsons are easy to fit, look great and bolt right into stock mounting holes.

Description	Part No.
FX-SHO (2008)	WR542
FZS/FZR (2009-2012)	WR543
FX/FX SHO (2012-2014)	WR551
VXR/VXS	WR552
FZR (2013)	WR554
FZR/FZS (2014)	WR556



SE "SPEED MAGIC" SPONSONS

FX-SHO (2012+), FX HO (2012), FX Cruiser HO (2012) & FX SVHO (2014)

Description	Color	Part No.
Speed Magic Sponsons	Silver	SE-101037SP
Speed Magic Sponsons	Gold	SE-101037GP



RIVA FZ PRO-SERIES STEERING SYSTEM

Key Features:

- Superior strength & rigidity over OEM system.
- Billet stainless steel steering shaft is much stronger than the OEM aluminum shaft.
- Cutting edge race styling.
- Variable height and tilt adjustment.
- Accepts both 7/8" bars & 1 1/8" Fat bars.
- Billet steering arm features adjustable "quick turn" settings.
- Retains Off Throttle Steering system.
- Race tested & proven on 2010 IJSBA/APBA tours.
- All aluminum parts anodized to prevent corrosion.
- Standard 3.5" tubes provide adjustment +/- 1" from OEM low position.
- Optional 5-1/2" & 7-1/2" tubes provide additional height choices.

Description	Part No.
RIVA FZ /FZS/FZ SHO Steering System	RY20050-U-3.5
RIVA Steering System 5 1/2" Tube Kit	RY20050-RK-5.5
RIVA Steering System 7 1/2" Tube Kit	RY20050-RK-7.5



SE "SPEED MAGIC" FZR/FZS STEERING SYSTEM

This billet steering system is the ultimate upgrade for the new Yamaha FZ watercraft. The system is extremely strong and allows the rider to change to handlebars of their choice.



Description	Part No.
Sato Engineering FZR/FZS Steering System	SE-027020



YAMAHA FZS/FZR/FZS SVHO BILLET HANDLEBAR ADAPTER

Description	Part No.
Yamaha FZS/FZR/FZS SVHO	SQ-HA-FZ



RIVA YAMAHA RIDE GRIP INSTALLATION KIT

- Allows installation of popular ODI 130mm grips on Yamaha RIDE models
- Precision machined from 6063 billet aluminum
- Anodized to prevent corrosion
- Sold as a pair. Grips sold separately (see pages 262-265)

Description	Part No.
Yamaha RIDE Grip Installation Kit for Yamaha PWC with RIDE system	RY24061-BES



FX-SHO/FZR/FZS/VXR/VXS R&D PRO COMP CLUTCH SAVER BILLET DRIVELINE COUPLER SET

Also available for MOD SHOP conversion hull kits.
The R&D Coupler set is designed to utilize the OEM Dampner Part# 921613711 (Not Included).

Description	Part No.
R&D Billet Coupler Set SHO/FX SVHO/FZR/VXR/VXS	612-01801



RIVA BILLET DRIVESHAFT SLEEVE KITS

RIVA's precision machined Billet Driveshaft Sleeve is a direct replacement for the thin factory rubber hose that is prone to distortion and failure. Sleeve is constructed of 6061 aluminum and is anodized to prevent corrosion. Kit includes high quality silicon couplers and stainless steel clamps. This upgraded sleeve kit is highly recommended for performance applications due to increased pump pressure that accelerates failure of original rubber hose.

Description	Part No.
RIVA Billet Driveshaft Sleeve Kit FX/FZ/SVHO All	RY30040-DSS
RIVA Billet Driveshaft Sleeve Kit VXR/VXS	RY30060-DSS

4 STROKE
YAMAHA

INTAKE
SYSTEMS

ENGINE/
GASKETS

EXHAUST

DRIVE LINE
HANDLING

ELECTRICAL

WATERLINE
/BILGE

STEERING
& CONTROLS

BODY

ACCESSORIES

SERVICE TOOLS
/HARDWARE

CHEMICAL



DRIVELINE COUPLER WRENCH

Description Driveline Coupler Wrench for SHO, FZR, VXR, VXS **Part No.** 132-57002



R&D FX-SHO/FZR/FZS/VXR/VXS AUTO TRIM NOZZLE KIT

The R&D FX-SHO/FZR/FZS Auto Trim Kit was developed to accommodate the OEM VTS Quick Shift System with a fully adjustable and fully automatic trim system! The R&D Auto Trim automatically drops to a rider preferred and adjustable 2-8 degrees. Drive from turn to turn never worrying whether the trim is in the best position for perfect turn negotiation! The R&D Auto Trim allows you to set the trim up your way to carve perfect turn every time! For long straight rides the R&D Auto Trim System works in conjunction with O.E.M VTS, so stock trim settings are retained, while the R&D Auto Trim takes over in the turns. The combination allows the best of both worlds for recreational and closed course riding!

Description FX-SHO (2008-12)/FX SVHO/FZ SVHO/FZR/FZS/VXR/VXS Auto Trim Nozzle Kit **Part No.** 162-18020



RIVA FZ BILLET MIRROR BLOCK-OFF KIT

RIVA's billet Block-off Kit covers the opening left in the hood when mirrors are removed for competition. Enhances craft's sleek lines and aerodynamics. Easy installation requires no special tools. Precision machined from billet aluminum and anodized to prevent corrosion. Includes installation hardware.

Description RIVA FZR/FZS/FZ SVHO Billet Mirror Block-Off Kit **Part No.** RY5-FZ-MB

R&D FX-SHO/FZR/FZS HYDRO FORCE STEERING NOZZLE



R&D's new Hydro Force Steering Nozzle for the FX-SHO/FZR/FZS is a direct replacement nozzle. The new lengthened design delivers a full 1 MPH speed gain over stock. The adjustable pivot position

improves the turning radius allowing you to carve tighter turns with a more positive feel. Improved performance through speed, acceleration and handling.

Description R&D FX-SHO (2008-12)/FX SVHO/FZ SVHO/FZR/FZS Hydro Force Steering Nozzle **Part No.** 162-14000

R&D FX-SHO/FZR/FZS VTS QUICK SHIFT CAM KIT



The R&D FX-SHO/FZR/FZS VTS Trim Driver Cam is a cam device that installs directly in place of the OEM plastic VTS trim driver cam. The R&D cam is designed to recalibrate the trim position amount from an OEM 7 to 8 degree per shift to a finer and speed friendly 4 degree per shift. The OEM SHO neutral position setting is 85 degree or 5 degree up from horizontal zero. The new recalibrated position with the new R&D Trim Cam is 87.5 degrees or 2.5 degree up from horizontal zero. The R&D Trim Cam will deliver a more positive group of adjustments that will allow much better turning capabilities, as well as finer adjustments for rough water conditions. The R&D Trim Cam will work with the OEM trim nozzle assembly, or the R&D Auto Trim Kit.

Description R&D FX-SHO (2008-12)/FX SVHO/FZR/FZS VTS Trim Driver Cam Kit **Part No.** 162-18010



RIVA VXR/VXS/VX REAR STORAGE TUB

Add 4 gallons of convenient under-seat storage to your VX or VXR/VXS watercraft. Durable plastic storage tub removes easily to allow access for maintenance. Fits all 2010-11 VX & 2011 VXR/VXS

Description RIVA VXR/VXS/VX Rear Storage Tub **Part No.** RY4-RST-060



TOM PERRY SPEAKING AT THE 2015 HOT PRODUCTS IJSBA MARK HAHN MEMORIAL HAVASU 300 ENDURANCE RACE AWARD CEREMONY IN LAKE HAVASU CITY, ARIZONA.

YAMAHA 4 STROKE
INTAKE SYSTEMS
ENGINE/GASKETS
EXHAUST
DRIVE LINE HANDLING
ELECTRICAL
WATERLINE /BILGE
STEERING & CONTROLS
BODY
ACCESSORIES
SERVICE TOOLS /HARDWARE
CHEMICAL



R&D FX-SHO/FZR/FZS/VXR/VXS ANTI-CAVITATION CONE

The R&D Anti-Cavitation Pump Cone Kit will reduce overall internal pump cavitation within the Yamaha's offset reduction/compression nozzle design. The OEM reduction/compression nozzle is offset, while the OEM pump cone/bearing cap remains straight which causes uneven pressures within the pump and reduction nozzle. The R&D Anti-Cavitation

Pump Cone is offset and reshaped to match the OEM reduction nozzle offset promoting even pressures, which will substantially reduce cavitation, increase pump hook up, boost acceleration, and increase top speed performance.

Description	Part No.
FX-SHO/FZR/FZS/VXR/VXS Anti-Cavitation Cone	162-18000



TBM RACING YAMAHA FZR/FZS/SO SUPER PUMP CONE

TBM's Super Pump Cone increases the hub diameter and smooths the transition of water flow through the rough casting of the OEM

stator vane assembly. This drastically improves hook up, acceleration and top speed on stock Waverunners although performance is enhanced exponentially as engine modification is increased. TBM has designed the Super Pump Cone to match the stock impeller; however any 75mm diameter hub aftermarket impeller will work. TBM's Super Pump Cone will also work in conjunction with Riva's 160mm wear ring/impeller upgrade. The kit comes complete with everything needed for installation with the exception of a spline tool for impeller removal/installation.

Description	Part No.
TBM Racing FZR/FZS/SO Super Pump Cone	TBM120-FZR



R&D BILLET ADJUSTABLE ANTI-CAVITATION CONE FOR YAMAHA SVHO

The R&D Billet Adjustable Pump Cone Kit is a bolt-on part designed to work with the stock SVHO venturi nozzle diameter. The R&D APC adds additional length over the OEM

cone, and comes complete with tuning spacers. The extended length allows custom RPM tuning, reduced cavitation, and adds additional pump thrust. Precision tuning the pump cones length with the kit included cone spacers will enable you to perfectly tune your pump for maximum thrust, superior holeshot, improved acceleration, and boosted top speed performance. Precision CNC machined from 6061 aluminum, anodized for corrosion resistance and O-ring sealed for leak-free pump bearing protection.

Description	Part No.
R&D Billet Adjustable Anti-cavitation Cone for Yamaha SVHO	162-18002



SOLAS YAMAHA 155MM WEAR RING HOUSING

The Brand New Solus Yamaha 155mm stainless steel wear ring housing is a solid cast piece that will not bulge from salt water use like the OEM one. This wear ring fits the Solas 12 vane 155mm pump, as well as the OEM stator section.

Description	Part No.
Solas 155mm Wear Ring Housing	YFS-HS-155



YSS-SV-160/74



YVS-SV-160-74

SOLAS STAINLESS STEEL YAMAHA 12-VANE STATOR SECTION

Pump Size	Hub Size	Part No.
160mm (SHO only, small water cooling outlet)	74mm	YSS-SV-160/74
160mm (SVHO & SHO, larger water cooling outlet)	74mm	YVS-SV-160-74



YVS-HS-160

SOLAS STAINLESS STEEL YAMAHA PUMP HOUSING

Pump Size	Application	Part No.
160mm	-	YVS-HS-160



2015 HOT PRODUCTS IJSBA MARK HAHN MEMORIAL HAVASU 300 ENDURANCE RACE IN LAKE HAVASU CITY, ARIZONA.

YAMAHA FX-SHO/SVHO/FZ/VXR/VXS PUMP



Includes a billet nose boot and impeller wrench.



Model	Year	Stock Engine	Limited Engine	Modified Engine
FZR-SVHO	2014	YV-CD-13/20	YV-CD-13/20, YV-CD-14/21	YV-CD-14/21
FZS-SVHO	2014			
FX-SVHO FX Cruiser SVHO	2014	YV-CD-13/20	YV-CD-13/20, YV-CD-14/21	YV-CD-14/21
FX HO/ FX Cruiser HO	2009+	YS-CD-13/19	YS-CD-13/22	YS-CD-13/22
VXR/VXS	2011+	YS-CD-13/19	YS-CD-13/22	YS-CD-13/22
FZR	2008+	YS-DF-14/21	YS-DF-14/21, YS-DF-15/22	YS-DF-15/22
FZS		YS-CD-13/22	YS-CD-13/22, YS-CD-14/23	YS-CD-14/23
		YS-TP-14/23	YS-TP-14/23	YS-TP-14/23
FX SHO/ FX Cruiser SHO	2008+	YS-DF-14/21	YS-DF-14/21, YS-DF-15/22	YS-DF-15/22
		YS-CD-13/22	YS-CD-13/22, YS-CD-14/23	YS-CD-14/23
FX High Output	2004-08	YG-DF-14/20	YG-DF-14/20, YG-DF-15/22	
FX Cruiser High Output	2004-08	YG-DF-14/20	YG-DF-14/20, YG-DF-15/22	YG-DF-15/22
VX/VX Sport VX Deluxe/VX Cruiser	2005+	YH-CD-18/22	YH-CD-18/22	

160-75-25-2 SWIRL

Model	Year	Stock	Limited	Modified
FZR-SVHO	2014	13/19	13/21	-----
FZS-SVHO	2014	13/19	13/21	-----
FX-SVHO	2014	13/19	13/21	13/23

160-75-25-2 SWIRL Part No.

Skat-Trak SVHO 13/19	SY607525-2SW1319
Skat-Trak SVHO 13/21	SY607525-2SW1321
Skat-Trak SVHO 13/23	SY607525-2SW1323

155-75-25 SWIRL

Model	Year	Stock	Limited	Modified
FZR	2009-13	12/20	-----	-----
FZS	2009-13	11/19	-----	-----
VXR	2012	11/18	12/19	13/20
VXS	2012	11/18	12/19	13/20
FX-SHO	2008-13	11/19	-----	-----
FX-Cruiser HO	2008-13	11/19	-----	-----

155-75-25 SWIRL Part No.

Skat-Trak FX-SHO/FZR/FZS 11/19	SY557525SW1119
Skat-Trak FX-SHO/FZR/FZS 12/19	SY557525SW1219
Skat-Trak FX-SHO/FZR/FZS 12/20	SY557525SW1220
Skat-Trak FX-SHO/FZR/FZS 13/20	SY557525SW1320
Skat-Trak FX-SHO/FZR/FZS 13/21	SY557525SW1321
Skat-Trak FX-SHO/FZR/FZS 13/22	SY557525SW1322
Skat-Trak FX-SHO/FZR/FZS 13/23	SY557525SW1323
Skat-Trak FX-SHO/FZR/FZS 13/24	SY557525SW1324
Skat-Trak FX-SHO/FZR/FZS 13/25	SY557525SW1325



SOLAS TWIN IMPELLERS

Model	Year	Stock Engine	Limited Engine	Modified Engine
FX SVHO		YV-TP-12/20	YV-TP-12/20	YV-TP-12/20
FX Cruiser SVHO	2014+			
FZR	2014+			
FZS	2014+			
FZR	2008-13	YS-TP-14/23	YS-TP-14/23	YS-TP-14/23
FZS	2008-13			

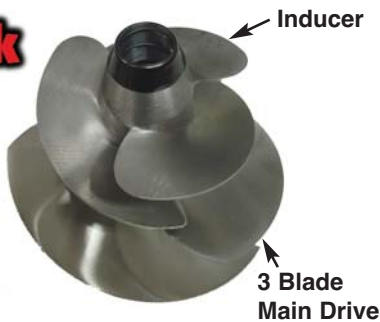

See Pages 174-175 for Flyboard Impeller Applications

SKAT-TRAK FX-SHO/FZR TWIN IMPELLERS

The new Twin Prop design drives of the line much quicker than the traditional single prop, and offers a substantial increase in rough water hookup. Twin impeller tools sold separately, see page 173.

	Engine Mods	Pitch	Part No.
Main Drive	Stock	12/18	SY557525SWM1218
Main Drive	Limited	12/20	SY557525SWM1220
Main Drive	Supermod	13/23	SY557525SWM1323

	Engine Mods	Pitch	Part No.
Inducer	Stock	12/17	SY440ID1217
Inducer	Limited	12/17	SY440ID1217
Inducer	Supermod	14/18	SY440ID1418



YUJI SHIOKI, 2ND IN MASTER SKI OPEN CLASS AT THE 2015 IJSBA QUAKYSENSE WORLD FINALS IN LAKE HAVASU CITY, ARIZONA. PEOPLE LIKE HIS STYLE, WITH SQUARE NOSE MODIFIED SUPERJET. PHOTO COURTESY OF JIN OMURA.



R&D KAWASAKI ULTRA 250/260/300/310 HIGH PERFORMANCE AIR INTAKE SYSTEMS

- Improved low end performance
- Great high performance tone
- Cooler engine air temperatures
- Cooler engine compartment temperatures
- Easy to install bolt on performance (no modification)
- Low cost performance advantages

The R&D Filter Kit is easy to install with no modifications required to the O.E.M. parts. IJSBA legal for all classes.

Description	Part No.
A. & B. R&D all models of Ultra 250/260/300/310 Cool Air Intake Kit	215-25000
<i>This kit consists of one of each 215-25001 & 215-24999</i>	
A. R&D all models of Ultra 250/260/300/310 Surge and Blowoff Valve Air Filter Kit Only (2 pieces)	215-25001
B. R&D all models of Ultra 250/260/300/310 Cool Air Intake Flat Filter Only	215-24999



R&D 12F/15F FLAME ARRESTOR

The R&D filter kit will unleash horsepower trapped in the restrictive stock air box. The exclusive lightweight filter design couples to the OEM throttle body, and is engineered with a large plenum to deliver massive cubic air volume and improved air speed. Kit comes complete with all necessary hardware.

Kawasaki	Part No.
R&D 12F/15F Flame Arrestor (Replacement for R&D #215-15010)	215-15011



RIVA ULTRA 250/260/300/310 PERFORMANCE POWER FILTER KIT

RIVA's Ultra Performance Power Filter Kit: Delivers greatly improved acceleration and increased top speed by replacing the restrictive stock intake system. The Power Filter feeds your supercharger with an increased volume of air via a large 4" diameter intake duct and oversized K&N filter element. Ducting is precision formed from a race proven composite that will not conduct heat to incoming air. Includes water-repellent pre-filter. IJSBA legal for all classes.

Description	Part No.
RIVA Racing Ultra 250X/250LX/260X/260LX Performance Power Filter Kit	RK13090
RIVA Racing Ultra 300X/300LX/310X/310XSE 310LX/310R Performance Power Filter Kit	RK13100
RIVA Replacement Power Filter only for RK13090/RK13096/RK13100	RK13090-2
RIVA Pre-Filter only for RK13090-2	RK13090PF-BK



RIVA ULTRA LX/STX-F PERFORMANCE POWER FILTER KIT

- Increases airflow and power.
- Installs easily.
- Mounts directly onto stock throttle body.
- Built to our specifications by K&N.
- Includes two smaller K&N filters for engine breather hoses and water repellent pre-filter cover for primary filter.

Kawasaki	Part No.
Ultra LX, STX-F Power Filter	RK13085

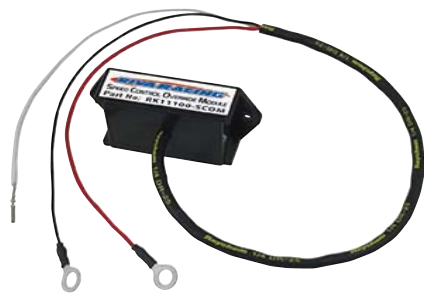

RIVA SPEED CONTROL OVERRIDE MODULE

- Removes restrictive speed limiter system.
- Increases top speed utilizing stock ECU.

- U.S. models will gain 3-4mph with no additional modifications.
- Allows further top speed gains through aftermarket modifications.
- All original dash functions are retained.
- Easy plug-in installation.

Description	Part No.
300X/300LX (2011-13),	RK11100-SCOM
310X/310LX/310XSE/310R (2014-16)	



R&D ULTRA 300X SPEED-UP MODULE (SPEED CONTROL OVERRIDE)

- 3-4 MPH top speed improvement
- Retains O.E.M dash functions, Eco mode, and Cruise Control
- Plugs into O.E.M. harness terminals for a factory looking install, completely stealth to the ECU
- Improved RPM performance (up to 300+)
- Full Boost levels achieved (2 pound boost addition)

- Top speed performance significantly improved.
- 10 minute plug and play performance
- Works well with all other performance bolt on parts (R&D Ride Plate & Aquavein Scoop Grates)

Description	Part No.
R&D Ultra 300X Speed-Up Module (2011-13)	801-15300
R&D Ultra 310X Speed-Up Module (2014-16)	801-15310

KAWASAKI 4-STROKE MODEL

MODEL	YEAR
ULTRA LX*	2007-2015
ULTRA 250X	2007-2008
ULTRA 250LX	2007-2008
ULTRA 260X	2009-2010
ULTRA 260LX	2009-2010
ULTRA 300X	2011-2013
ULTRA 300LX	2011-2013
ULTRA 310X	2014-2016
ULTRA 310XSE	2014-2016
ULTRA 310LX	2014-2016
ULTRA 310R	2014-2016
STX 12F	2004-2008
STX 15F	2004-2016

*Normally Aspirated



ULTRA 300/310 HIGH PERFORMANCE ECU REPROGRAMMING SERVICES

Part #801-03001 R&D R1 ECU; Reprogrammed ECU to allow up to 8650 RPMs. R1 upgraded ignition timing safe for all recreational and offshore racing use using 91 octane pump gasoline.

Part #801-03002 R&D R2 ECU; Reprogrammed ECU to allow up to 8750 RPMs. R2 upgraded ignition timing safe for all recreational and offshore racing use using 91 octane pump gasoline.

Part #801-03003 R&D R3 ECU; Reprogrammed ECU to allow up to 8850 RPMs. R3 upgraded ignition timing safe for all recreational and offshore racing use using 93-95 octane pump gasoline. The R3 ECU program will also work well with mild (R&D RC1) camshafts kits, R&D Forged Piston Upgrades and mild supercharger pulley upgrades where boost levels will be increased by no more than 2 pounds. The R3 program file does not require a Powershot Fuel Tuner.

NOTE: Rev Limiter settings can be raised or lowered upon request. R&D is also developing E85 fuel programs that utilize the R&D 340LPH Fuel Pump, and R&D 725 or 1000cc Injectors.

Existing customers who have purchased an R&D Powershot Fuel Control Unit can send their units in to R&D for free upgraded re-programming to allow custom fuel tuning to work with the new ECU Programs. R&D Powershot Fuel Control Units are not required on entry recreational level (R1, R2, or R3) programs. However, custom fuel tuning with the Powershot Fuel Tuner can be an add-on or additional upgrade that is suggested for higher performance applications with Booster Wheels or Camshaft Kits. Fuel tuning or AFR conditions should always be checked and verified as values will always be slightly different from one engine set up to another.

ECU reflashing is recommended for competition use only.



2015 HOT PRODUCTS IJSBA MARK HAHN MEMORIAL HAVASU 300 ENDURANCE RACE OVERALL CHAMPIONS, RUNABOUT: JEAN BRUNO PASTORELLO & JEAN-BAPTISTE BOTTI, KAWASAKI ULTRA

KAWASAKI 4 STROKE
INTAKE SYSTEMS
ENGINE/ GASKETS
EXHAUST
DRIVE LINE HANDLING
ELECTRICAL
WATERLINE /BLGE
STEERING & CONTROLS
BODY
ACCESSORIES SERVICE TOOLS /HARDWARE
CHEMICAL

KAWASAKI
4 STROKE
INTAKE
SYSTEMS
ENGINE/
GASKETS
EXHAUST
DRIVE LINE
HANDLING
ELECTRICAL
WATERLINE
/BILGE
STEERING
& CONTROLS
BODY
SERVICE TOOLS
ACCESSORIES
/HARDWARE
CHEMICAL



R&D UNIVERSAL FUEL PRESSURE REGULATOR

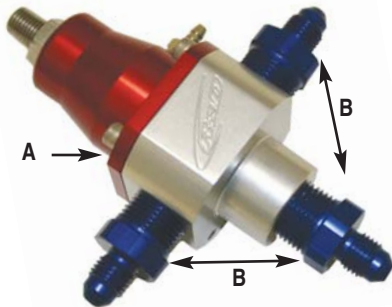

Universal bypass fuel pressure regulator for carbureted or EFI fuel systems applications. Base fuel pressure is adjustable from 20 to 60 PSI with high pressure spring (installed). Ideal for carbureted and EFI bypass applications where more flow and superior pressure control are desired.

The universal type bypass style regulator is capable of handling any fuel pump up to 250 GPH. Replace "Deadhead" regulator performance and experience full flow volume and steady fuel pressure.

Description	Part No.
A. R&D Universal Fuel Pressure Regulator only (Fittings not included) For Ultra 250/260/300/310	801-25010
B. #4 AN Straight Fitting (Blue Anodized) (Sold individually)	611-27503

R&D ULTRA 300/310 RISING RATE FUEL PRESSURE REGULATOR



R&D's Ultra 300/310 Fuel Pressure Regulator Kit allows custom fuel pressure tuning to the EFI's fuel system. The R&D Fuel Pressure Regulator System offers a wide range of setup possibilities making it the only fuel pressure tuning system you will ever need. Base fuel pressure is adjustable from 5 to 80 PSI. The R&D fuel pressure regulator can also be set up to allow "rising rate" fuel pressure at a 1 to 1 ratio (One pound of fuel pressure gain over base for every pound of boost gain). The R&D fuel pressure regulator comes completely assembled and connects directly to the fuel rail with OEM security lock connectors. The R&D bypass style regulator system is capable of handling any fuel pump up to 250 GPH. Replace "Deadhead" regulator performance and experience the full flow volume and rock steady fuel pressure that only a dynamic R&D fuel pressure regulator kit can produce. Kit comes complete with mounting bracket and pictorial instructions.

- Fuel pressure will rise on a 1:1 ratio when boost referenced
- Beautiful type II bright dip anodized finish
- Bypass design produces the ultimate, dynamic fuel delivery system
- R&D offers pre-assembled #4 AN hose to finish off a return system
- Uses all OEM security lock connectors

Description	Part No.
R&D Rising Rate Fuel Pressure Regulator Complete Kit for Ultra 300/310	801-30000



R&D FUEL PRESSURE GAUGE



R&D offers the Autogage fuel pressure gauge gives the best reference in verifying and monitoring fuel pressure precisely on any supercharged or boosted engine. 0 to 100 psi.

Description	Part No.
R&D Fuel Pressure Gauge	900-02180

SWEDGE TOOL



FUEL PUMP



R&D UNIVERSAL HIGH PERFORMANCE HIGH VOLUME FUEL PUMP KITS

All R&D fuel pumps have been precision flow rate tested and charted in (LPH) liters per hour. R&D fuel pumps arrive complete with terminal connectors for both

the new high performance pumps quick connect installation, as well as extra terminal connector parts for the O.E.M. pump for use when converting back to stock. The R&D quick connect terminals help make fuel pump testing easy when switching from a low pressure to a high pressure fuel pump.

Description	Part No.
R&D 255 LPH (Liter Per Hour) Low Pressure Fuel Pump Kit	811-25255
R&D 255 LPH (Liter Per Hour) High Pressure Fuel Pump Kit	811-25256
R&D 340 LPH (Liter Per Hour) High Pressure Fuel Pump Kit	811-35340
R&D Fuel Pump Swedge Tool*	811-25257

*NOTE: R&D High Performance fuel pumps are .040 larger than O.E.M. Mitsubishi fuel pumps on Yamaha's and Kawasaki's, therefore it may be necessary to use the R&D Fuel Pump swedge tool to enlarge the fuel pump housing for easy installation.



WSM REPLACEMENT FUEL PUMP

Description	Part No.
O.E. No.:49040-3715, 49040-3718, 49040-3720 Fits: STX-12 F 1200 (2004-07), STX-15F 1200 (2004-12) STX 1500 (2009-10), Ultra LX 1500 (2007-13), Ultra 250 1500 (2007-08), Ultra 260 1500 (2009-10), Ultra 300 1500 (2011-13)	004-810



R&D ULTRA 250/260/300 POWERSHOT ADJUSTABLE FUEL TUNER

The R&D Powershot fuel injection tuner will deliver increased horsepower, acceleration, and stronger mid-range performance by

delivering a higher performing Air to Fuel Ratio (A.F.R) to engine. Many of today's high performance fuel injected four stroke muscle craft have a lean A.F.R. R&D Performance has tested, documented, and analyzed the O.E.M fuel maps on every current fuel injected four stroke watercraft, and pre-programmed and coded the new R&D Powershot fuel injection control module to safely alter the O.E.M. fuel map to a higher performing and safer A.F.R. (richer). More horsepower, greater acceleration and stronger mid-range are the result when the proper A.F.R. is achieved and is tuned for optimum performance.

The R&D Powershot is fully adjustable on the fly (with the engine running, observed and tuned while riding), and will accommodate a wide range of adjustability to properly performance tune the A.F.R. for any combination of aftermarket parts. The R&D Powershot will add horsepower, reliability, and adjustability to any electronic fuel injected two or four stroke personal watercraft engine.

*Competition use only.

Description	Part No.
R&D Ultra 250/260/300X Powershot Fuel Tuner	801-25000



ULTRA 250/260/300/310 OEM FUEL PUMP PRESSURE REGULATOR BLOCKOFF FITTING

R&D offers a Fuel Pump Pressure Regulator Blockoff Fitting Kit which will allow the O.E.M. stock in tank fuel pressure regulator to be removed completely and replaced with a billet part which is necessary when installing an aftermarket externally adjustable fuel pressure regulator. The R&D fitting is manufactured to "Deadhead" or block the port solid, however, the fitting is pre-machined and tapped and can be relief drilled to be able to install a Mikuni Super BN Series Main (High) jet directly into the fitting for a small in tank restrictor jet which for fine tuning fuel pressures. *Mikuni Jet not included.

Description	Part No.
R&D 250/260/300/310 Fuel Pump Pressure Regulator Blockoff Fitting	811-25100



DEEP FUEL PROBE FOR ULTRA 300/310

The PILOT Deep Fuel Probe is a must have for the Kawasaki Ultra 300/310. The PILOT Deep Fuel Probe will take full advantage of the 20+ gallons of fuel, which currently is not accessible with the stock fuel pump pickup. The PILOT Deep Fuel Probe lowers the

stock pickup to the bottom of the fuel tank, allowing the fuel pump to utilize all the available fuel in the tank, a must have for endurance and offshore racing.

Description	Part No.
Kawasaki Ultra 300/310 Deep Fuel Probe	PRU3DFP
Kawasaki 12F/15-F Deep Fuel Probe	PRP-U15DFP



R&D ULTRA 250/260/300/310 DEEP FUEL PICKUP

The R&D Deep Fuel Pickup is designed to maximize fuel volume. The stock fuel pickup is located horizontally in the gas tank three inches above the bottom of the tank. This leaves approximately 5 gallons of unusable fuel in the bottom of the tank. The R&D Deep Fuel Pickup relocates the stock fuel pickup to the bottom of the tank in a vertical position. The new positioning allows for 24 percent more riding time per tank of gas.

Description	Part No.
R&D Ultra 250/260/300/310 Deep Fuel Pick Up	801-25100



SE ULTRA 250/260/300/310 DEEP FUEL PICKUP

Description	Part No.
SE Ultra 250/260/300/310 Deep Fuel Pick Up	SE-019031

OIL FILTER & SPARK PLUGS



K&N PERFORMANCE GOLD OIL FILTER

Description	OEM#	Part No.
All Kawasaki Four Stroke PWC	16097-0003	KN204
	16097-0004	



CR9EK
(10 plugs/box)



PMR9B
Platinum
(4 plugs/box)



IU27/IU27A
Iridium
(4 plugs/box)

Model	NGK	Denso
Ultra 250X/260X/300X/310X	PMR9B	IU27
Ultra LX/STX12F/STX15F	CR9EK	IU27A

*Sold per box only

KAWASAKI
4 STROKE

INTAKE
SYSTEMS

ENGINE/
GASKETS

EXHAUST

DRIVE LINE
HANDLING

ELECTRICAL

WATERLINE
/BILGE

STEERING
& CONTROLS

BODY

ACCESSORIES

SERVICE TOOLS
/HARDWARE

CHEMICAL



R&D ULTRA 250X/260X SUPERCHARGER WHEEL BILLET HUB KIT

The R&D Supercharger Hub Kit will replace the O.E.M.'s vulnerable part with a redesigned and beefed up precision CNC



Machined 6061 billet aluminum part that is much stronger than stock.

Description	Part No.
R&D Ultra 250X/260X Supercharger Wheel Hub Kit	611-25001

ADA ULTRA 250X/260X/150/12F/15F BILLET DRIVE COUPLERS

Billet aluminum drive coupler set for the Kawasaki 250X & 260X. The crank side coupler with the pulley is 1.24lbs lighter than the stock steel coupler. The pulley diameter is the same as stock. Uses the stock rubber



31-700590

dampener. Clear anodized for protection against saltwater corrosion. *These couplers do not fit the Ultra 300X or the Ultra 310 models.*

Description	Part No.
Ultra 250X/260X Billet Drive Coupler Set	31-700590
Ultra 150/12F/15F Billet Drive Coupler Set	31-700490



R&D ULTRA 310 HIGH BOOST SUPERCHARGER PULLEYS

- 4-5 MPH top speed improvement with more boost (depending on package)
- Seriously noticeable acceleration performance improvements
- Super easy to install
- Uses OEM belt tensioner assembly
- Significantly improved cornering with more engine torque
- Drives through chop with superior power authority
- Utilizes all OEM engine internals

Description	Part No.
Pulley Wheel/Ratio .970 to 1 (16-17 Lbs boost)	611-30016
Pulley Wheel/Ratio .1.021 to 1 (18-19 Lbs boost)	611-30018



R&D DRIVE LINE COUPLER REMOVAL TOOL (CRANKSIDE)

Description	Part No.
Ultra 300/310 Crankside Coupler Wrench	132-57003



R&D ULTRA 250X/260X SUPERCHARGER PULLEYS

The new R&D Racing Supercharger Pulley Wheel will deliver a noticeable and impressive boost in torque and overall horsepower. The R&D Pulley is 3/4 lb lighter than the O.E.M. steel pulley, and delivers 2.5 to 3.5 lbs of additional boost pressure along with 30 horsepower. The holeshot acceleration is a solid 1.5-2 boat lengths over stock with a top speed gain of 1 to 2 mph over stock.

R&D strongly recommends the use of the R&D Powershot Fuel Tuner, R&D High Output Fuel Injectors and High Volume Fuel Pump Kit to increase fuel flow delivery when using the R&D Supercharger Wheel. Not using these recommended parts can result in engine damage due to a lean air fuel ratio.

Description	Part No.
R&D Supercharger Pulley Wheel 1 to 1 (entry level)	611-25011
R&D Supercharger Pulley Wheel 1.05 to 1	611-25105
R&D Supercharger Pulley Wheel 1.1 to 1	611-25110
OEM Replacement Supercharger Pulley	611-25010



R&D ULTRA 250X/260X SUPERCHARGER BELT TENSIONER WHEEL & BEARING REBUILD KIT

Description	Part No.
R&D Ultra 250X/260X Supercharger Belt Tensioner Wheel	611-25000
R&D Ultra 250X/260X Bearing Rebuild Kit*	611-25009

* For the use of R&D supercharger pulleys and tensioner wheel only.



R&D ULTRA 250X/260X SUPERCHARGER WHEEL PULLER TOOL

The R&D wheel puller tool makes it fast and easy to remove a supercharger wheel without the removal of the intercooler system or the water muffler assembly. The R&D Supercharger drive wheel puller will save at least an hour on a pulley removal and replacement. A must have tool.

Description	Part No.
R&D Ultra 250X/260X SC Wheel Puller Tool	611-26004



R&D ULTRA 250X/260X DRIVER WHEEL HOLDER TOOL

The R&D Holding Tool makes it fast and easy to remove and re-install a supercharger wheel without damaging or breaking the wheel hub. Use the holding tool to properly torque the drive bolts and main spline drive bolt. A must have tool.

Description	Part No.
Ultra 250X/260X Driver Wheel Holder Tool	611-26003

KAWASAKI 4 STROKE
INTAKE SYSTEMS
ENGINE/GASKETS
EXHAUST
DRIVE LINE HANDLING
ELECTRICAL
WATERLINE/BILGE
STEERING & CONTROLS
BODY
ACCESSORIES
SERVICE TOOLS/HARDWARE
CHEMICAL

ULTRA 250/260 • SUPERCHARGER



ULTRA 250/260/300/310 ADJUSTABLE BOOST CONTROL VALVE KIT

The R&D Adjustable Boost Control Valve replaces the unreliable OEM Plastic boost control valve that quite often fails to hold consistent factory recommended boost pressure settings. A leaking and inconsistent boost control valve will cause a 10-30 horsepower loss in performance. The all aluminum constructed High Performance R&D Adjustable Valve offers perfect sealing and precise adjustment for consistent boost pressure control. The valve comes factory preset for 16 pounds boost and is adjustable up to 22 pounds. The valve mounts directly to the OEM location with a billet aluminum adaptor that offers boss locations that can be used to install a boost gauge. For those with a reprogrammed R&D ECU, this is a must have upgrade to allow the ECU to perform to full potential. Kit includes all gaskets, hardware and installation instructions.

Description	Part No.
Ultra 250/260/300/310 Adjustable Boost Control Valve Kit	611-25210



R&D AUTOMETER 0-35 PSI UNIVERSAL BOOST GAUGE

R&D offers the Autometer Ultra-Lite Series 2" mechanical boost gauge to give the best reference in verifying and monitoring boost levels precisely. The Autometer Gauge kit comes complete with all the necessary hardware, and 10 feet of nylon tubing to install on any watercraft.

Description	Part No.
R&D Autometer Universal Boost Gauge	900-04304
R&D Ultra 250/260 Boost Gauge Adapter	611-26002

**NOTE: It will be necessary to order an R&D Boost Gauge Adapter Kit for the specific make and model of engine.*



R&D ULTRA 250/260 BOOST GAUGE ADAPTER

The R&D Boost Adapter installs between the supercharger and the waste gate and allows the ability to mount a boost gauge to it via 1/8" fitting. This will enable an accurate measurement of boost the supercharger is delivering. Kit comes with gaskets and hardware.

Description	Part No.
R&D Ultra 250/260 Boost Gauge Adapter	611-26002



R&D ULTRA WASTE GATE BLOCK-OFF KIT

The CNC machined part allows the supercharger to deliver its boost without premature pressure loss from a leaking waste gate. Kit comes complete with gaskets and hardware.

Description	Part No.
R&D Ultra 250/260 Waste Gate Block-Off Kit	611-26001

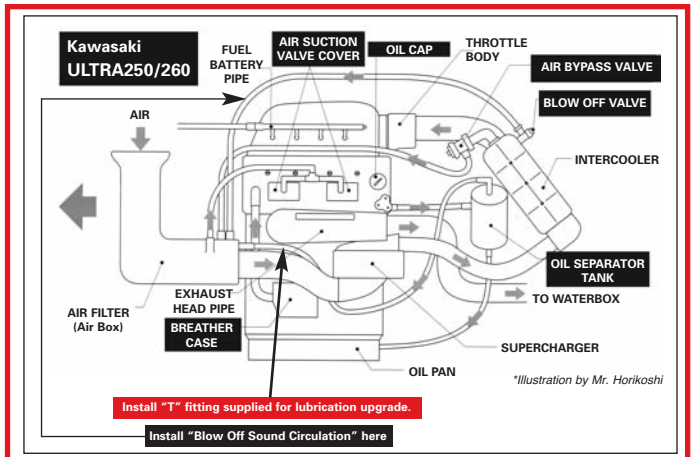

ULTRA 250/260 LUBRICATION UPGRADE KIT

Upgrade your Ultra 250/260 to have a lubrication inlet nozzle kit like the **Ultra 300** has directly from the **Kawasaki factory**. This kit will allow you to spray a aerosol lubricant of your choice into the supercharger, intercooler and throttle body to prevent rust from the excess moisture in the system. Complete instructions, pictures and a diagram supplied for a simple installation.

Description	Part No.
A. Ultra 250/260 Spray Nozzle Inlet for Lubrication	IWCS-USU
B. Replacement Plug for Nozzle Inlet Kit	IWCS-SU-P

ULTRA 250/260/300/310 BLOW OFF SOUND CIRCULATOR

The blow off circulator is installed into the air hose located back of the seat. This small piece fits in the blow off return line hose. When you let off the throttle and the blow off valve opens the part will create a racing performance sound from the part.

Description	Part No.
Blow Off Sound Circulator Ultra 250/260/300/310 (All)	DC-BSS

Hear the sound created by the circulator at You Tube

KAWASAKI
4 STROKE
INTAKE SYSTEMS
ENGINE/GASKETS
EXHAUST
DRIVE LINE HANDLING
ELECTRICAL
WATERLINE /BILGE
STEERING & CONTROLS
BODY
ACCESSORIES
SERVICE TOOLS /HARDWARE
CHEMICAL



RIVA ULTRA 250 (08)/260/300/310 FREE FLOW EXHAUST KIT

High quality mandrel bent aluminum exhaust tube will survive meltdowns & backfires. Includes billet exhaust outlet with laser etched graphics that is anodized to prevent corrosion. High temperature silicone couplers included along with detailed installation instructions.

2014 Ultra 300: For use with RIVA Pro-Series Water Box order coupler RK15-2.38/3.25 to connect Free Flow Exhaust Tube to Pro-Series Water Box.

2011-12 Ultra 300: Replaces soft rubber exhaust hose with sturdy aluminum tubing. For maximum performance, use with RIVA Pro-Series Water Box (part# RK16091-1).

2008-10 Models: Replaces restrictive 1 3/4" rubber exhaust hose with large 2 1/4" aluminum tubing & outlet. For maximum performance, use with RIVA Pro-Series Water Box (part# RK16091-1). Can also be utilized with OEM water box using silicone reduction coupler (part# RK16090-08-ERC).

Description	Part No.
RIVA Racing Free Flow Exhaust Kit Ultra 250 (08), 260 (2009-10), 300 (2011-12)	RK16090-08
Free Flow Exhaust Kit Ultra 310 (2014-16)	RK16110

RIVA EXHAUST REDUCTION COUPLER

Fits: **2009-10 Ultra 260 & 2008 Ultra 250.**
High-temp silicone reduction coupler allows RIVA Free Flow Exhaust Kit (Part # RK16090-08) to be used with the stock water box.

Description	Part No.
RIVA Exhaust Reduction Coupler	RK16090-08-ERC

ROGUE RACING ULTRA VALVE COVER BLOCK OFFS

Features:

- Inexpensively replaces worn or leaking valves
- Lowers exhaust temperatures
- More consistent top speed averages
- More responsive low end performance
- Lowers exhaust back pressures
- More precise AFR tuning

Description	Part No.
Rogue Racing Ultra 250X/LX (07-08), STX-15F/12F Valve Cover Block Offs	EBOP-BLK



RIVA RACING PRO-SERIES ULTRA 250/260/300/310 WATER BOX

Developed on RIVA's Dyno and tested extensively on the water, this water box features radiused exhaust tubes and end caps for optimum exhaust flow. Unique exhaust baffle will increase the low-end power and mid-range pull of your Kawasaki Watercraft. Delivers up to 15hp on modified engines along with significant torque gains. High-strength aluminum construction will survive backfires and meltdowns. Powder coated to prevent corrosion. A must for modified motors. Includes detailed installation instructions.

Key Features:

- Delivers up to 15hp on modified craft.
- Machined hose flanges for reliable coupler retention.
- Radiused exhaust tubes & end caps.
- Powder coated to prevent corrosion.

2014-16 Ultra 310: Direct replacement for original water box. Use with stock exhaust outlet hose or RIVA Free Flow Exhaust Kit (part# RK16110) and coupler RK15-2.38/3.75.

2011-13 Ultra 300: Direct replacement for original water box. Use with stock exhaust outlet hose or RIVA Free Flow Exhaust Kit (part# RK16090-08).

2008-10 Models: Direct replacement for original water box. Features larger outlet (2-1/4") compared to stock water box (1-3/4"). Must be used with RIVA Free Flow Exhaust Kit RK16090-08.

2007 Models: Direct replacement for original water box. Use with RIVA Free Flow Exhaust Kit (Part # RK16090).

Description	Part No.
RIVA Ultra 250/260/300/310 Pro-Series Water Box	RK16091-1



RIVA RACING BILLET EXHAUST TIP FOR ULTRA 250X/LX, STX-15F/12F

Quickly and easily add style to your craft with this direct replacement for

the stock, plastic exhaust tip. Made from billet aluminum with laser etched graphics. Anodized to prevent corrosion.

Description	Part No.
RIVA Racing Billet Aluminum Exhaust Tip Ultra 250X/LX (07), STX-15F (2004-14)/STX-12F (2003-08)	RK16086



RIVA COUPLER

Required when installing RIVA Pro-Series Water Box in conjunction with Free Flow Exhaust Kit RK16110.

Description	Part No.
Coupler 2.38" x 3.25"	RK15-2.38/3.25



R&D ULTRA 300/310 PERFORMANCE EXHAUST PLATE

The R&D Performance Exhaust Plate replaces the restrictive OEM exhaust honeycomb filter that Kawasaki recommends inspecting or replacing every 25 hours. The R&D Exhaust Plate eliminates excessive exhaust heat and flow restriction produced by the OEM exhaust filter. Improved exhaust flow decreases back pressure, and heat and increase performance. The Exhaust Plate also features small water ports that decrease water flow to the water box, which eliminates hard starting conditions from wet spark plugs. The R&D Exhaust upgrade never needs to be inspected or replaced. Kit comes complete with gaskets to install.

Competition use only. (CARB) California Air Resources Board emissions regulations prohibits sales of this product to California Dealers.

Description	Part No.
R&D Ultra 300/310 Performance Exhaust Plate	331-35300



R&D ULTRA 310 FREE FLOW EXHAUST

The new R&D Kawasaki 310X Free Flow Exhaust Kit is the largest kit manufactured for the 310. It wakes up your engine's performance by reducing exhaust back pressure and excessive exhaust heat. The R&D kit eliminates the number two outgoing water box completely. It also replaces the super restrictive 2.200" OEM exhaust transom outlet with a new full 3" outlet! The R&D kit is a must-install kit to seriously reduce heat and back pressure when running higher engine RPMs that come along with higher boost pulleys, ECU mods, camshaft kits, or any other power adders for the Kawasaki!

Description	Part No.
R&D Ultra 310 Free Flow Exhaust	331-35310



SE-098062 SE-098066 SE-098069 SE-098070S

SE "SPEED MAGIC" ULTRA 250/260/300/310 EXHAUST FLANGE

SE "Speed Magic" billet exhaust flanges create a unique and personalized look. Anodized and utilizes the OEM exhaust flange mounting holes.

Description	Color	Part No.
Trumpet Flange	Silver	SE-098062
Cyclone Flange	Silver	SE-098066
Megaton 4 Flange	Silver	SE-098069
Type 5 Flange	Silver	SE-098070S



RIVA ULTRA 300/310 EXHAUST RACE PLATE

RIVA's Exhaust Race Plate allows easy removal of restrictive honeycomb element on Ultra 300/310 for competition use. OEM exhaust element is located inside exhaust manifold obstructing exhaust flow and producing excessive heat. Installation of Race Plate increases horsepower and reduces under-hood operating temperatures. Plate is precision machined out of high quality stainless steel.

Competition use only. (CARB) California Air Resources Board emissions regulations prohibits sales of this product to California Dealers.

Description	Part No.
RIVA Ultra 300/310 Exhaust Race Plate	RK18100-ERP



ULTRA 250/260 INTERCOOLER TEMPERATURE CONTROL UPGRADE KIT

- More horsepower with cooler intake air temperatures
- Increased acceleration and mid range performance
- Reduces detonation in hot weather conditions
- Temperature control tuneability
- An inexpensive recreational performance addition
- Pressure relief valve preserves O.E.M. intercooler
- Easy installation instructions

Description	Part No.
R&D 250/260 Intercooler Temperature Control Upgrade Kit	660-82500



ULTRA 250/260/300/310 5 PORT COOLING MANIFOLD

The R&D 5 Port Extra Cooling Manifold is a bolt on part that replaces the OEM cooling manifold mounted to the top of the jet pump. For offshore and high performance use where engine loads are sustained for longer distances, R&D recommends adding extra cooling to the engine, oil cooler, and intercooler. The R&D manifold provides 3 additional ports over the stock manifold. CNC machined from billet aluminum, o-ringed sealed and anodized for corrosion resistance. Kit comes complete with five 1/2" fittings. Additional 1/2 to 1/2 through-hull water fittings (R&D Pt. # 660-00012) required for each additional line, order as needed.

Description	Part No.
R&D 5 Port Extra Cooling Manifold For Ultra 250/260/300/310	660-82501

KAWASAKI
4 STROKE

INTAKE
SYSTEMS

ENGINE/
GASKETS

EXHAUST

DRIVE LINE
HANDLING

ELECTRICAL

WATERLINE
/BILGE

STEERING
& CONTROLS

BODY

ACCESSORIES

SERVICE TOOLS
/HARDWARE

CHEMICAL



RIVA ULTRA VALVE TRAIN UPGRADE KIT

RIVA's Valve Train Upgrade Kits increase the reliability of your modified engine by reducing the possibility of valve float at high rpm. Includes lightweight, precision-machined titanium valve retainers, racing valve springs, and base washers.

Description RIVA Ultra Valve Train Upgrade Kit
Part No. RK19085-VTU
 Ultra 250/260, STX-15F



RIVA KAWASAKI HIGH PERFORMANCE VALVE SET

- Stronger & lighter than stock valves.
- Redesigned valve heads for improved air flow & strength.
- High grade stainless intake valves resist corrosion.
- Inconel exhaust valves resist heat from high boost applications.

- Valve stems feature hard-chrome plating for superior wear & lubricity.
- Includes high strength valve locks.
- Sold in sets of 16 (8 Intake/8 Exhaust)

Description RIVA Ultra 250/260, STX-15F*
Part No. RK19085-HPV-0
 High Performance Valve Set
 *300X exhaust valves are 1mm larger than 250/260



PRO-X VALVE SHIM KIT

Easy and economical replacement shims. Precision machined to match exact size. Specific heat-treatment ensuring hardness to offer maximum durability and less wear.

Description Pro-X Valve Shim Kit
Part No. 29.VSA948

*This Pro-X Valve Shim Kit is for Kawasaki STX-12F (03-04), STX-15F (04-09), Ultra LX (07-09), Ultra 250X (07-08), Ultra 260X (09-10)



RIVA VALVE COMPRESSION TOOL

RIVA's overhead Valve Compression Tool allows easy removal of valve springs and keepers without removing the cylinder head. Includes compression adapter to pressurize cylinder keeping valves in place during removal of stock springs and keepers. Fits both Kawasaki 1.5L & Yamaha 1.8L 4-stroke engines.

Description RIVA Valve Compression Tool
Part No. RY19040-VCT
 Fits Kawasaki 1.5L 4-stroke & Yamaha 1.8L



GP PISTON KITS FOR KAWASAKI

Ultra 250X (2007-08), Ultra 260X (2009-10) Ultra 300X (2011-13)
 SuperCharged 4 stroke, DOHC inline 4 cylinder Stock CR: 8.4:1
 Stock Bore: 3.267 (83mm) Stock Stroke: 2.724 (69.2mm)

PISTON KIT	DESCRIPTION	RING #
M4049	83mm Standard Bore (1498cc) 2009 - 12 Kawasaki Ultra 260X 9.5:1 Turbo	CPN-3268
M4050	83mm Standard Bore (1498cc) 2009 - 12 Kawasaki Ultra 260X 10.5:1 Turbo	CPN-3386

Stock Bore: 3.267 (83mm)

*Sold as Kit (4 pistons per kit)

**Piston sold complete with: rings, piston pin and locks



JE PISTON KITS FOR KAWASAKI ULTRA 250X/260X/300X

MODEL	PISTON KIT #	DISP.	BORE SIZE	OVER SIZE	COMP. RATIO	RING #
250X/260X	274213	1498cc	83mm	STD	9.5:1	JG1001-3268
250X/260X	290051	1498cc	83mm	STD	10.5:1	JG1001-3268
300X	300271	1498cc	83mm	STD	9.5:1	JG1001-3268
300X	300272	1498cc	83mm	STD	10.5:1	JG1001-3268

*Sold as Kit (4 pistons per kit)

**Piston sold complete with: rings, piston pin and locks



WISCO PISTON KITS FOR KAWASAKI ULTRA 260LX/260X

Kawasaki Model	Years	Bore x Stroke (mm)	Piston Kit Number	Replacement Ring Set	Pins & Clips
ULTRA 260LX ULTRA 260X	2009-10 8.4:1 Compression	83.00 x 69.2	40048M08300*	8300XX	Wrist Pin S624 Circlips CW28
ULTRA LX STX 15-F STX	2009-10 2008-10 2009-10 10.6:1 Compression	83.00 x 69.2	40052M08300*	3268XG	Wrist Pin S561 Circlips CW21

ArmorGlide™ Skirt Coated

Piston sold complete with: rings, piston pin and circlips.

*Sold individually



CARRILLO CONNECTING RODS

Description Carrillo Connecting Rod Set
Part No. KA-STX15->8M4449S-04
 ULTRA 250/260/300 & STX-15F (sold 4 rods per set)

ULTRA 250/260/300/310 • ENGINE



GASKET KIT FOR KAWASAKI 4-STROKE

Description	Complete	Top End
STX-12F (2003-07), STX (2009-10)	007-645-05	007-645-06
STX-15F (2004-12), Ultra LX (2007-13)		
Ultra 250 (2007-08), Ultra 260 (2009-10)	007-646	007-646-01
Ultra 300X (2011-13), Ultra 300LX (2011-13)	007-646-02	007-646-03

INDIVIDUAL GASKETS FOR KAWASAKI 4-STROKE

Description	OEM Part No.	Our Part No.
Head 2007-10 250/260/300LX/300X Supercharged	11004-3723	3723
Head 2003-14 STX 12F/15F & Ultra LX	11004-3721	3721
Base - All Models	11061-3708	3708
Intake Manifold Grafoil (OEM) 2003-14 STX 12F/15F, Ultra 250/260, Ultra LX	11061-3716	3716-G
Intake Manifold Green Fiber 2003-14 STX 12F/15F, Ultra 250/260, Ultra LX		3716-P
Exhaust Manifold 2003-14 12F/15F	11061-3713	3713
Exhaust Pipe 2003-14 12F/15F, Ultra LX	11061-3714	3714
Muffler Ultra 300X	11061-3768	3768
Compressor 2011-14 Ultra 300X & LX / 310 All	11061-3763	3763
Compressor Intake 2007-10 Ultra 250/260X & LX	11061-3764	3764
Output Cover 2003-14 All Models	11061-0812	0812-1
Muffler 2007-14 Ultra 250/260/300LX/300X/310All		3768
Muffler 2007-10 Ultra 250/260X	11061-3760	3760
Exhaust Pipe 2007-14 250/260/300/310	11061-3762	3762
Exhaust Manifold 2007-14 250/260/300/310	11061-3742	3742
Valve Cover All Kawasaki 4-Stroke	11061-0090	0090-1
Oil Pan All Kawasaki 4-Stroke Grafoil	11061-3710	3710G
Oil Pan All Kawasaki 4-Stroke Green Fiber		3710P

Head Gasket No. 3721 OEM 11004-3721	Head Gasket No. 3723 OEM 11004-3723	Base No. 3708 OEM 11061-3708	Intake Manifold No. 3716G/P OEM 11061-3716	Exhaust Manifold No. 3713 OEM 11061-3713
			 3716G 3716P	
Exhaust Pipe No. 3762 OEM 11061-3762	Exhaust Pipe No. 3714 OEM 11061-3714	Muffler Ultra 300X No. 3768 OEM 11061-3768	Muffler 250/260 No. 3760 OEM 11061-3760	Output Cover No. 0812-1 OEM 11061-0812
Valve Cover No. 0090-1 OEM 11061-0090	Compressor No. 3763 OEM 11061-3763	Exhaust Manifold No. 3742 OEM 11061-3742	Compressor No. 3764 OEM 11061-3764	Oil Pan No. 3710G/P OEM 11061-3710
				 3710G 3710P

KAWASAKI
4 STROKE
INTAKE
SYSTEMS
ENGINE/
GASKETS
EXHAUST
DRIVE LINE
HANDLING
ELECTRICAL
WATERLINE
/BLGGE
& CONTROLS
BODY
ACCESSORIES
SERVICE TOOLS
/HARDWARE
CHEMICAL

KAWASAKI
4 STROKE
INTAKE
SYSTEMS
ENGINE/
GASKETS
EXHAUST
DRIVE LINE
HANDLING
ELECTRICAL
WATERLINE
/BILGE
STEERING
& CONTROLS
BODY
ACCESSORIES
SERVICE TOOLS
/HARDWARE
CHEMICAL



RIVA ULTRA PRO-SERIES STEERING SYSTEM

Introducing the ultimate race proven steering system for your Kawasaki Ultra. Fully adjustable design features a dual tube steering head for maximum strength & rigidity. Directly replaces bulky OEM mechanism with a stronger & lighter unit that provides variable height options. Delivers a precision feel and the confidence to push your craft to the limit with improved dependability and comfort. Bulletproof bar clamp will accept any 7/8" handlebar or 1 1/8" fat bars. Includes all necessary installation hardware and instructions.

Key Features:

- Superior strength & rigidity over OEM system.
- Cutting edge race styling.
- Variable height and handlebar tilt adjustment.
- Accepts both 7/8" bars & 1 1/8" Fat bars.
- Retains Off Throttle Steering system.
- Race tested & proven on 2010 IJSBA/APBA tours.
- All aluminum parts anodized to prevent corrosion.
- Standard 8 3/4" tubes provide adjustment.
- Optional 11 1/2" tube kit provides additional height choice.
- Fits Kawasaki Ultra 250/260/300/310 models.

NOTE: Requires use of **Aftermarket Handlebars**.

Description	Part No.
RIVA Ultra 250/260/300/310 Steering System	RK20090-U-8.75
RIVA 11.75" Tube Kit for RK20090	RK20090-RK-11.75



RIVA ULTRA 250/260 STEERING COLUMN COVER

This lightweight cover fills the large void left when the stock steering system is removed. Designed for use with UMI Steering System and highly recommend when using RIVA Pro-Series Power Filter Kit (part# RK13096).



Description	Part No.
RIVA Ultra 250/260 Steering Column Cover	RK5-SCC-090

RIVA ULTRA PRO-SERIES STEERING LOWER

RIVA's Steering System Lower replaces the inferior stock steering plate mount that wear out and fails over time. Constructed with billet aluminum and high quality stainless steel materials along with high quality sealed cartridge bearings ensuring smooth precise steering. Billet steering arm provides an infinite amount of steering ratio adjustment and incorporates a dampening effect enabling you to ride in any conditions with complete confidence and control. Supplied billet lower clamp provides additional tilt adjustment for increased comfort.

Key Features:

- Superior strength & rigidity over OEM system.
- Cutting edge materials and design.
- Variable tilt adjustment.
- Retains Off Throttle Steering system.
- Race tested & proven on 2011 IJSBA/APBA tours.
- All aluminum parts anodized to prevent corrosion.
- Requires **RIVA Ultra Pro-Series Steering System (part# RK20090-U-8.75)**
- Fits Kawasaki Ultra 250/260/300/310 models.

Description	Part No.
RIVA Ultra Lower System Steering Assembly	RK20090-L

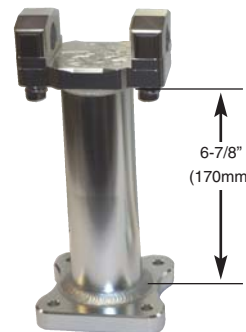

SE-027013



SE-027300

SE (SATO ENGINEERING) HANDLEBAR MOUNT

- Easy installation to replace stock steering part
- Accepts aftermarket handlebar
- Taper tube construction provides strength
- Improves handling
- SE-027300 is 26mm longer to avoid contact with the switch box in handlebar and reverse lever
- Made in Japan. Very popular item in Japan.

Description	Part No.
SE Handlebar Mount Ultra 250/260	SE-027013
SE Handlebar Mount Ultra 300/310	SE-027300



ULTRA 250/260/300 AFTERMARKET BILLET HANDLEBAR ADAPTER

This billet aluminum handlebar adapter was developed to allow a rider the ability to install aftermarket handlebars on the Kawasaki Ultra 250, 260, 300 and 310. This simple conversion will greatly improve steering and control.

Description	Part No.
Ultra 250/260/300/310 Billet Handlebar Adapter	DC-HA-KU



SE-101035SW



SE "SPEED MAGIC" ULTRA 250/260/300/310 SPONSON WITH FIN

Sponson Paddles

The sponsons are adjustable and have 4 positions

Backing plate:

- The backing plates are aluminum for maximum strength
- Standard backing plate was developed for the Ultra 250/260
- Wide backing plate was developed for the 300/310 and creates a more stable ride at speed

Backing plate adjustable lifter

- Both of the backing plates feature an adjustable rear lifter, by adjusting the lifter up you increase speed (photo A), lower the lifter and you will increase bow pressure thus creating more stability (photo B).



Stabilizer wing

- These sponsons feature an exterior horizontal adjustable wing, by adjusting it up you create straight line tracking, by adjusting it down you increase rough water stability and turning ability

Description	Part No.
Standard Back Plate - Silver Outside Plate	SE-101035
Standard Back Plate - Green Outside Plate	SE-101035GR
Wide Back Plate - Silver Outside Plate	SE-101035SW



RIVA RACING ULTRA 250/260/ 300/310 PRO-SERIES SPONSON KIT

Rear View of Backing Plate

Description	Part No.
RIVA Ultra 250/260/300/310 Pro-Series Sponson Kit	RK26090



R&D ULTRA 250/260/300/310 SPONSON KIT

Description	Part No.
R&D Ultra 250/260/300/310 Sponson Kit	121-25001



Description	Part No.
Worx Ultra 250/260 Ultra LX Sponson Kit	WR536
Worx Ultra 300/310 Sponson Kit	WR547



2015 Hot Products IJSBA MARK HAHN MEMORIAL HAVASU 300 ENDURANCE RACE OVERALL CHAMPIONS, RUNABOUT: JEAN BRUNO PASTORELLO & JEAN-BAPTISTE BOTTI, KAWASAKI ULTRA.

KAWASAKI
4 STROKE

INTAKE
SYSTEMS

ENGINE/
GASKETS

EXHAUST

DRIVE LINE
HANDLING

ELECTRICAL

WATERLINE
/BILGE

STEERING
& CONTROLS

BODY

ACCESSORIES
SERVICE TOOLS

/HARDWARE

CHEMICAL

KAWASAKI
4 STROKE

INTAKE
SYSTEMS

ENGINE/
GASKETS

EXHAUST

DRIVE LINE
HANDLING

ELECTRICAL

WATERLINE
/BILGE

STEERING
& CONTROLS

BODY

ACCESSORIES

SERVICE TOOLS
/HARDWARE

CHEMICAL



R&D ULTRA 250/260/300/310 AQUAVEIN SCOOP GRATE

Description	Part No.
R&D Ultra 250X/LX, 260X/LX(All years), Aquavein Scoop Grate	111-25000
R&D Ultra 300X/LX, 310X/LX Aquavein Intake Grate*	111-30000



R&D ULTRA 250/260/300/310 PUMP SHOE SEAL KIT

Model	Intake Grate	Pump Seal Kit
Ultra 250/260 All Years	111-25000	161-25000
Ultra 300/310 All Years	OEM	161-30000
Ultra 300/310 All Years	111-30000	161-30001

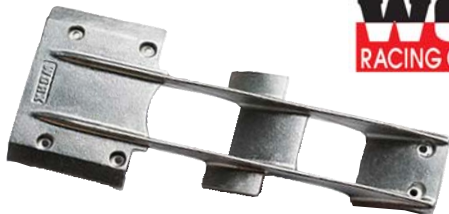

WORX
RACING COMPONENTS

WORX 250/260 INTAKE GRATE

Description	Part No.
Worx Ultra 250/260 Intake Grate	WR227
Worx Ultra 300/310 Intake Grate	WR236



SE-065026

SE "SPEED MAGIC" INTAKE GRATE

Description	Part No.
SE Intake Grate Ultra 300/310	SE-065026



RIVA ULTRA 300/310 TUNABLE TOP-LOADER INTAKE GRATE

Description	Part No.
RIVA Ultra 300/310 Tunable Top-Loader Intake Grate	RK22100



RIVA ULTRA 300/310 PERFORMANCE RIDE PLATE

Key Features:

- Improves Hook up & Handling
- Provides Quicker Planing
- Integrated Reverse Gate Brackets
- Powder Coated to Prevent Corrosion
- Reduces Porpoising
- IJSBA Race Legal
- Includes speedo sender block-off

Description	Part No.
RIVA Ultra 300/310 Performance Ride Plate	RK21100



R&D ULTRA 250/260/300/310 HIGH PERFORMANCE RIDE PLATE

- 2 plus MPH top speed improvement
- Unique industry first multi-step concept
- Improved straight line stability
- Significantly improved cornering
- Reduced chine walking on high speed sweepers
- Drives through chop with superior stability
- Retains reverse gate mounting and operation.

Description	Part No.
R&D Ultra 250/260 High Performance Ride Plate	121-25000
R&D Ultra 300/310 High Performance Ride Plate	121-30000

ULTRA 250/260/300/310 • IMPELLERS



KX CONCORD

PITCH	PART NUMBER
10/16	KX-CD-10/16
15/23	KX-CD-15/23
16/24	KX-CD-16/24

KR CONCORD

PITCH	PART NUMBER
14/21	KR-CD-14/21
15/22	KR-CD-15/22

RECOMMENDED SOLAS IMPELLER

Model	Year	Engine cc	Pump Dia.	Series	Stock Engine	Limited Engine	Modified Engine
Ultra 310X/310XSE/310LX/310R	14-15	1498	160mm	CONCORD	KR-CD-14/21	KR-CD-14/21 or KR-CD-15/22	KR-CD-15/22
Ultra 300X/300LX	11-13	1498	160mm	CONCORD	KR-CD-14/21	KR-CD-14/21 or KR-CD-15/22	KR-CD-15/22
Ultra 260X/260LX	09-10	1498	160mm	CONCORD	KX-CD-15/23	KX-CD-15/23 or KX-CD-16/24	KX-CD-16/24
Ultra 250X	07-08	1498	155mm	CONCORD	KX-CD-15/23 or KX-CD-16/21	KX-CD-15/23 or KX-CD-16/24	KX-CD-16/24
Ultra LX	07-14	1498	155mm	CONCORD	KX-CD-10/16	KX-CD-10/16	-----
STX 15-F	04-14	1498	148mm	CONCORD	KG-CD-14/21	KG-CD-14/21	KG-CD-15/21
STX 12-F	04-08	1199	148mm	CONCORD	KG-CD-13/19	KG-CD-13/19	KG-CD-14/20



ULTRA 250/260 LX/X 155-75-20 SWIRL

PITCH	PART NUMBER
13/18	SK557520SW1318
13/19	SK557520SW1319
14/19	SK557520SW1419
14/20	SK557520SW1420

ULTRA 300 LX/X 160-83-20 SWIRL

PITCH	PART NUMBER
16/21	SK608320SW1621
16/22	SK608320SW1622
16/23	SK608320SW1623

ULTRA 310 LX/X 160-83-20-2 SWIRL

PITCH	PART NUMBER
16/21	SK608320-2SW1621
16/22	SK608320-2SW1622
16/25	SK608320-2SW1623

RECOMMENDED SKAT-TRAK IMPELLER

Model	Year	Pump Dia.	Stock Engine	Limited Engine	Modified Engine
Ultra 310X/310R/310XSE	14-15	160mm	SK608320-2SW1621	SK608320-2SW1622	SK608320-2SW1623
Ultra 300X	11-13	160mm	SK608320SW1621	SK608320SW1622	SK608320SW1623
Ultra 300LX	11-13	160mm	SK608320SW1621	SK608320SW1622	SK608320SW1623
Ultra 260X	09-10	155mm	SK557520SW1419	Call for application	Call for application
Ultra 260LX	09-10	155mm	SK557520SW1419	Call for application	Call for application
Ultra 250X	07-08	155mm	SK557520SW1318	SK557520SW1318 or SK557520SW1319	SK557520SW1319 or SK557520SW1420
Ultra LX	07-14	155mm	SK557520SW1016	Call for application	Call for application
STX 12-F	04-08	148mm	*SK1100SW1319 or SK1100SW1319R**	SK1100SW1420	Call for application
STX 15-F	04-14	148mm	*SK1100SW1319 or SK1100SW1319R**	Call for application	Call for application

*Suggested for maximum bottom-to-mid range acceleration gains. **Suggested for maximum top speed gains.



Check Page 174-175
for Flyboard Impeller
Applications

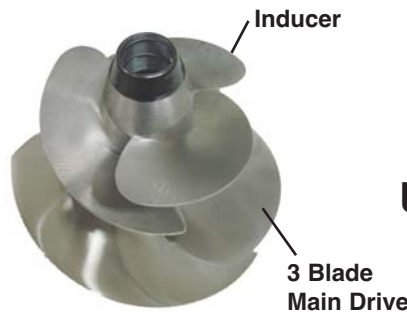

SKAT-TRAK TWIN IMPELLERS ULTRA 250/260/300/310

ULTRA 250X/260X

Engine Mods	Pitch	Part No.
Main Drive Stock	12/18	SK557520SWM1218
Main Drive Limited	12/20	SK557520SWM1220
Main Drive Supermod	13/23	SK557520SWM1323

Engine Mods	Pitch	Part No.
Inducer Stock	12/17	SK440ID1217
Inducer Limited	12/17	SK440ID1217
Inducer Supermod	14/18	SK440ID1418

ULTRA 300X

Engine Mods	Pitch	Part No.
Main Drive Stock	16/21	SK608320SWM1621
Main Drive Limited	16/22	SK608320SWM1622
Main Drive Supermod	16/23	SK608320SWM1623

Engine Mods	Pitch	Part No.
Inducer Stock	13/18	SK440ID1318
Inducer Limited	14/19	SK440ID1419
Inducer Supermod	15/20	SK440ID1520

KAWASAKI
 4 STROKE
 INTAKE SYSTEMS
 ENGINE/ GASKETS
 EXHAUST
 DRIVE LINE HANDLING
 ELECTRICAL
 WATERLINE /BILGE
 STEERING & CONTROLS
 BODY
 ACCESSORIES SERVICE TOOLS /HARDWARE
 CHEMICAL

KAWASAKI
4 STROKE

INTAKE
SYSTEMS

ENGINE/
GASKETS

EXHAUST

DRIVE LINE
HANDLING

ELECTRICAL

WATERLINE
/BILGE

STEERING
& CONTROLS

BODY

SERVICE TOOLS
ACCESSORIES

/HARDWARE

CHEMICAL



R&D ULTRA 250/260/300/310 1 DEGREE NOZZLE WEDGE KIT

The R&D 1 Degree Reduction Nozzle Wedge Kit for the Ultra 250/260/300/310 will add quicker acceleration and top speed performance as well as allow the bow to ride slightly higher which will significantly reduce annoying bow spray promoting a much dryer ride. Extensive testing has led our development team to wedge the reduction nozzle up 1 full degree which will inexpensively give better handling everywhere and provide a boost of up to 1 mph in top speed performance. The billet aluminum CNC machined 1 degree reduction nozzle wedge kit was specifically designed to work without compromising or removing the O.E.M. reverse gate. The R&D Pump Wedge Kit comes complete with all hardware and instructions for easy installation.

Description	Part No.
R&D Ultra 250/260 One Degree Nozzle Wedge Kit	141-25001
R&D Ultra 300/310 One Degree Nozzle Wedge Kit	141-30000



R&D ULTRA 250/260/300/310 DRIVESHAFT SHIM KIT

The R&D driveshaft shims install into the prop snout and removes the unwanted play or float the driveshaft has in the prop/pump assembly. Properly shimming the driveshaft will keep the driveshaft couplers fully engaged eliminating premature rubber dampener wear and failure.

Description	Part No.
R&D Ultra 250/260/300/310 Driveshaft Shim Kit	161-00810



TBM RACING ULTRA VANE EXTENDING TAIL CONE

With the four vane extenders integrated into the tail cone the turbulent water in the pump is controlled and straightened for a longer distance. They also centered the tip of the tail cone in the bore of the nozzle to even the pressures inside the compression nozzle. All this translates to improved hook up, acceleration and a noticeable gain in top speed.

Description	Part No.
TBM Racing Ultra 250/260/300/310X or LX Ultra Vane Extending Tail Cone	TBM120-UL



003-614

WSM ULTRA JET PUMP REPAIR KIT

Description	Part No.
12F (05-07), 15F (05-10), 250X (07-08), Ultra LX (07-10), STX-R (05)	003-614
15F (11-13), 260X (09-10), 300X (11-13)	003-614-01



R&D ULTRA 250/260/300/310 ANTI-CAVITATION PUMP CONE KIT

The R&D Anti-Cavitation Pump Cone is off-set 5 degrees and reshaped to match the O.E.M. reduction nozzle offset promoting even pressures, which will substantially reduce cavitation, increase pump hook up, boost acceleration, and increase top speed performance.

Description	Part No.
R&D Ultra 250/260/300/310 Anti-Cavitation Pump Cone Kit	161-25010



KAWASAKI COUPLER PULLER

Description	Part No.
Coupler Puller OEM #57001-1423 Housing 12F/15F/Ultra 150/250/260	003-310



TBM RACING KAWASAKI DRIVELINE BEARING HOUSING SUPPORT

The TBM driveline bearing housing support is 50% lighter. TBM uses these supports on every high performance competition and recreational Kawasaki stand-up and runabout they build to ensure the bearing housing doesn't self destruct from the increased stress and rpm of a modified craft. Fits JS650, 550SX, 750 and 800 stand-ups and every year and model Kawasaki runabout.

Description	Part No.
TBM Racing Kawasaki Driveline Bearing Housing Support	TBM141



003-109-02



003-109-03

WSM KAWASAKI REPLACEMENT PUMPSHAFT

Kawasaki	OEM No.	Part No.
Ultra 250 (07-08)	13107-3788	003-109-02
Ultra 260X & LX (2009)	13107-3809	
Ultra LX (07-11)		
Ultra LX 3 Pass (09-10)		
Ultra 300 LX (11-13)	13107-0728	003-109-03
Ultra 300 X (11-13)	13107-0764	
Ultra LX (12-13)		

ATLANTIS FLUSH KITS



SNAP CONNECT & FLOW CONTROL

This flush kit includes adapter and also includes a quick disconnect that features a on/off water valve to make flushing the watercraft a simple and easy process.

Description	Part No.
Snap Connect and Flow Control Set	SC-2900
A. Adaptor Only	SC-2905



Description	Part No.
Ultra 300/310X, LX.	A7005
One Plug for Drain Flush another for Intercooler.	



Description	Part No.
2003-10 4-Stroke	A2628
The Ultra 250X/260X, LX & the STX-15F flush fitting is located inside of the hood. A2628 Flush Kit provides a locking quick disconnect valve which can be installed and left on for continued use with the female locking quick disconnect fitting.	



VERSIPLUG "THE ORIGINAL" DRAIN SYSTEM

Versiplug is a self-bailing drain plug system produced using aircraft grade aluminum, water resistant plastic and stainless steel. Installation is simple, quick and easy. The kit will completely drain your PWC without you having to do anything.

Description	Color	Part No.
Versiplug Drain System	Silver	PD1300
Versiplug Drain System	Black	PD1301



RIVA RACING ULTRA 250/260/300/310 BLOCK-OFF KIT

Lightweight carbon coated epoxy plates cover openings left in hood when mirrors are removed for competition. Easy installation requires no special tools. Reverse Lever Block-off plate sold separately. Fits all Ultra 250/260/300 models.

Description	Part No.
Ultra 250/260/300/310 Mirror Blockoff Kit	RK5-U250X-MB
Ultra 250/260/300/310 Reverse Lever Blockoff Kit	RK5-U250X-RLB



BILLET QUICK DRAIN

Mounts to the transom of your Kawasaki Personal Watercraft with billet aluminum mounting plate.

Description	Part No.
Billet Drain System	57-4065

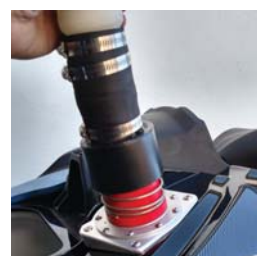

Filler Neck



SQUADRON ULTRA 250/260/300/310 OIL CAP

The Squadron Oil Cap features a clear window to allow you to see the internal parts of your engine. The oil cap comes in three color options and is anodized to prevent corrosion and wear.

Description	Part No.
Squadron Red with Silver Ring Billet Oil Cap	DCR-OIL-01

QUICK FILL ADAPTER PLATE FOR ULTRA

Allows the use of 2" Quick Fill Neck. This plate has been specifically developed and tested on Kawasaki Ultras. Allows for a clean, secure installation of a 2" quick fill. Quick Fill receiver not included.

Description	Part No.
Quick Fill Adapter Plate	PRP-U3QFP

KAWASAKI	4 STROKE
INTAKE SYSTEMS	
ENGINE/GASKETS	
EXHAUST	
DRIVE LINE HANDLING	
ELECTRICAL	
WATERLINE /BILGE	
STEERING & CONTROLS	
BODY	
ACCESSORIES	
SERVICE TOOLS /HARDWARE	
CHEMICAL	

RRP RICKTER

**FREESTYLE
FREERIDE**

**INTAKE
SYSTEMS**

**ENGINE/
GASKETS**

EXHAUST

**DRIVE LINE
HANDLING**

ELECTRICAL

**WATERLINE
/BILGE**

**STEERING
& CONTROLS**

BODY

ACCESSORIES

**SERVICE TOOLS
/HARDWARE**

CHEMICAL



All RRP poles are supplied with 26" tubes.*

- Extra Strong design using 6061 T6 aluminum tube.
- Quickly adjustable from +2 inches to -1 inches (total of 3" of adjustability) without cutting tube.
- Handlepoles are supplied with both Yamaha & Kawasaki pole bushings.
- Optional RRP handlepole bracket enables installation of 2-1/5" air intakes (engine breathes through the pole tubes and chin pad).
- Requires RRP or SuperJet (96+) Style Chin Pad

*RRP recommends cutting the tubes to a length of 23.5" for Kawasaki and Yamaha applications.



RRP SUPER LITE ADJUSTABLE HANDLEPOLE FOR RICKTER, KAWASAKI, YAMAHA AND OCTANE

RRP Super Lite Handlepoles are recommended for freestyle riding.

Description	Tube Color	Part No.
Super Lite Pole Green	Black	HP-BILLET-LITE-GN
Super Lite Pole Silver	Silver	HP-BILLET-LITE-SLV
Super Lite Pole Red	Black	HP-BILLET-LITE-RD
Super Lite Pole Black	Silver	HP-BILLET-LITE-BLK
Super Lite Pole Blue	Black	HP-BILLET-LITE-BLU

RRP BILLET ADJUSTABLE HANDLEPOLE FOR RICKTER, KAWASAKI, YAMAHA AND OCTANE

RRP Billet Handlepoles are recommended for racing and freeride.

Description	Tube Color	Part No.
Billet Pole-Green	Black	HP-YAM/KAW-BLT-GN
Billet Pole-Silver	Silver	HP-YAM/KAW-BLT-SLV
Billet Pole-Red	Silver	HP-YAM/KAW-BLT-RD
Billet Pole-Black	Silver	HP-YAM/KAW-BLT-BLK
Billet Pole-Blue	Black	HP-YAM/KAW-BLT-BLU



RRP CAST ADJUSTABLE HANDLEPOLE FOR RICKTER, KAWASAKI, YAMAHA AND OCTANE

Description	Tube Color	Part No.
Cast Pole Black	Silver	HP-YAM/KAW-CAST
Cast Pole White	Black	HP-YAM/KAW-CAST-WH



RRP BILLET ADJUSTABLE HANDLEPOLE FOR HYDROSPACE

Description	Tube Color	Part No.
Billet HydroSpace Pole	Silver	HP-HS-BLT-BLK



RRP ALUMINUM REPLACEMENT HANDLEPOLE TUBES

RRP Aluminum replacement tubes fit all RRP handlepoles. Tubes sold individually.

Description	Length	Tube Color	Part No.
RRP Aluminum Tube	26"	Green	AL-TUBE-26-GN
RRP Aluminum Tube	26"	Black	AL-TUBE-26-BLK
RRP Aluminum Tube	26"	Blue	AL-TUBE-26-BLU
RRP Aluminum Tube	26"	Red	AL-TUBE-26-RD
RRP Aluminum Tube	26"	Silver	AL-TUBE-26-SLV
RRP Aluminum Tube	23.5"	Silver	AL-TUBE-23.5-SLV

*RRP handlepole tubes sold individually



RRP CARBON TUBESS

New 100% carbon fiber tubes for that freestyle rider looking to build the lightest possible ski. These carbon tubes have a weight savings of appx 60% compared to the RRP standard aluminum tubes. Not recommended for Freeriding or Surf skis.

Description	Length	Part No.
RRP Carbon Tube	20"	CB-TUBE-20
RRP Carbon Tube	26"	CB-TUBE-26

*RRP handlepole tubes sold individually

RRP HANDLEPOLE CONVERSION EASY ORDERING RECOMMENDATIONS

Step #1 – HANDLEPOLE

Yamaha 96+ Superjet, Kawasaki SXR and RICKTER
 RRP Super Lite Pole (colors)**HP-BILLET-LITE-COLOR**
 Billet Pole (Colors).....**HP-YAM/KAW-BLT- COLOR**
 Cast Pole (Black).....**HP-YAM/KAW-CAST**
 Cast Pole (White).....**HP-YAM/KAW-CAST-WHT**
 Hydrospace
 Billet (Black).....**HP-HS-BLT-BLK**
 See page 76 for additional information

Step #2 – HANDLEPOLE BRACKET

All RRP Handlepoles work with OEM brackets.
 RRP Recommends:
 Yamaha 96+ Superjet.....**BR-YAM-L-2H**
 Kawasaki SXR.....**BR-KAW-2H**
 RICKTER.....**BR-RICKTER-BLK**
 See page 78 for additional information



Step #3 – HANDLEPOLE SPRING

RRP recommends a Yamaha OEM 96+ Superjet handlepole spring for RICKTER, Yamaha and Kawasaki applications. The OEM spring must be used with a RRP Spring Tensioner when using the RRP handlepole bracket.
 RICKTER and Yamaha 96+ Superjet.....**SP-BL-YAM**
 Kawasaki SXR.....**SP-BL-KAW**
 See page 78 for additional information
 Blowsion 96+ Superjet handlepole spring**03-04-012**
 Watercraft Werks Spring**58-5704**
 also will work on the RRP handlepoles.
 See page 253 for additional information
 • Riders and competitors looking for a tight handlepole setup and do not want to utilize a handlepole spring, see page 78 for RRP handlepole spacers.



Step #4 – STEERING SYSTEM

28.6mm RRP**STR-SYST-UNI-F-COLOR-S**
Fat Bar Steering System
 22.2mm RRP**STR-SYS-UNIV-KIT-COLOR**
Standard Bar Steering System
 See page 80-81 for additional information



Step #5 – HANDLEBARS

RRP Fat Bars 28.6mm for STR-SYST-UNI-F-COLOR-S
 RRP Straight Bars**ST-B-F**
 50mm RRP Riser Bars**50-B-F**
 75mm RRP Riser Bars**75-B-F**
 4 Degree RRP Bars**4DEG-B-F**
 RRP Standard Bars 22.2mm for STR-SYST-UNIV-KIT-COLOR
 RRP Straight Bars.....**ST-B**
 See page 81 for additional information
 Hot Products, Blowsion and RIVA Racing “V Bend” bars will also fit STR-SYST-UNIV-KIT-COLOR
 See pages 248-249 for additional information



Step #6 – CHIN PADS

RRP Ninja Carbon**RRP-NIN-PAD-COLOR**
 Chin Pad
 See page 79 for additional information
 RRP Standard**RRP-PAD-CB-L-COLOR**
 Carbon Chin Pad
 See page 79 for additional information



Step #7 – STEERING STOP

RRP Steering Stops ...**ST-STOP-UNIV-COLOR**
 also functions as a chin pad support
 *RRP Ninja Chin pads require the use of the RRP Steering Stop.
 See page 81 for additional information



Step #8 – PROTECTIVE PAD

RRP recommends**AST-PAD-COLOR**
 the AST Pad for all RRP Fat Bar Steering Systems
 See page 80 for additional information
 *The AST Protective pad is required for racing and freestyle freeride competitions when using the RRP Fat Bar Steering system (STR-SYST-UNI-F-COLOR-S)

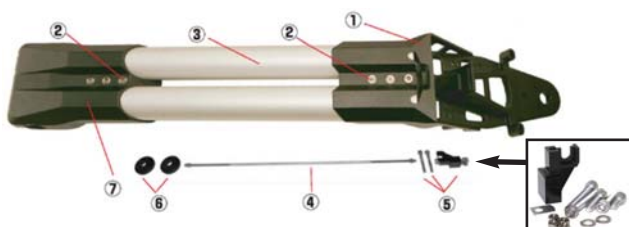

RRP REPLACEMENT PARTS FOR RRP HANDLEPOLES

Description	Part No.
1. RRP Cast Pole Replacement Upper Part for Part # HP-YAM/KAW-CAST (Black)	UPPER PART
2. RRP Cast Handlepole Bolt Kit (Set of 3 bolts with nuts)	RRP-HP-CST-BLT
3. RRP Replacement Tubes (Sold individually)	See Page 76

4. RRP Threaded Safety Rod for 26" Tube	TR-26
4. RRP Threaded Safety Rod for 23.5" Tube	TR-23.5
5. RRP 5mm Steering Cable Hardware	STR-BLK-5MM
5. RRP 6mm Heavy Duty Steering Cable Hardware	STR-BLK-6MM
6. RRP Yamaha Cast Pole Bushings (sold in pairs)	BU-YAM
6. RRP Kawasaki Cast Pole Bushings (sold in pairs)	BU-KAW
6. RRP Yamaha pre 1995 & FX-1 SuperJet Cast Pole Bushings (sold in pairs)	BU-YAM-92-95
6. RRP Hydrospace Bushings (sold in pairs)	BU-HYDRO
6. RRP Yamaha Billet Pole Bushings (sold in pairs)	BU-BILLET-YAM
6. RRP Kawasaki Billet Pole Bushings (sold in pairs)	BU-BILLET-KAW
7. RRP Cast Pole Replacement Bottom Part for Part # HP-YAM/KAW-CAST (Black) Includes the RRP-HP-CST-BLT (#2 in diagram above)	BOTTOM PART

**FREESTYLE
FREERIDE**

**INTAKE
SYSTEMS**

**ENGINE/
GASKETS**

EXHAUST

**DRIVE LINE
HANDLING**

ELECTRICAL

**WATERLINE
/BILGE**

**STEERING
& CONTROLS**

BODY

ACCESSORIES

**SERVICE TOOLS
/HARDWARE**

CHEMICAL

**RRP BILLET
HANDLEPOLE BRACKETS**



Yamaha 96+ Superjet lowered bracket features 2 air holes. Includes air tubes and billet front hood clips.

Description	Part No.
Yamaha SJ96+ (Black)	BR-YAM-L-2H



Kawasaki SXR bracket features 2 air holes and includes air tubes. Front hood hooks not included.

Description	Part No.
Kawasaki 800SXR (Black)	BR-KAW-2H



RICKTER bracket features 2 air holes and includes air tubes. Front hood hooks not included. Fits many of the aftermarket hulls available.

Description	Part No.
Rickter Hull (Black)	BR-RICKTER-BLK



RRP BREATHER AIR TUBE

Description	Part No.
RRP High Flow Breather Air Tube 2.5" OD x 24" length* *Flex hose only. Sold individually.	FL-HO-24

**SJ 90-95
HANDLEPOLE
CONVERSION
BRACKET**



WATCON handlepole mount conversion bracket. Run a 1996 & later Round Nose Super Jet pole, stock or aftermarket on an earlier 1990-95 Square Nose SJ.

Description	Part No.
SJ 90-95 Handlepole Conversion Bracket	HPM-SNRN1



**RRP LIGHTWEIGHT
ALUMINUM PIVOT BOLT**

RRP developed this lightweight aluminum bolt to fit the RRP handlepole brackets and OEM Superjet. Made from 7075 High Grade Aviation Aluminum.

Description	Part No.
Yamaha	AL-PIV-BLT-YAM
Kawasaki NEW	AL-PIV-BLT-KAW



**RRP POLE
SPRING STIFFENER**

When you install a RRP 2 hole air inlet bracket BR-YAM-L-2H, BR-RICKTER or a BR-KAW-2H and want to run the OEM handlepole spring you must use this part to create the proper tension and handlepole weight. This part only fits the RRP Handlepole Brackets.

Description	Part No.
RRP Yamaha and Rickter Pole Spring Stiffener	SP-BL-YAM
RRP Kawasaki Pole Spring Stiffener	SP-BL-KAW



Pad not included. PW-01-100

**PRO WATERCRAFT
SLASHER CHIN PAD**

Description	Part No.
For Original RRP Cast Handlepole (Black Finish)	PW-RR-100
For Latest RRP Cast Handlepole (Black Finish)	PW-RR-102
For RRP Billet Handlepole (Black Finish)	PW-RR-101

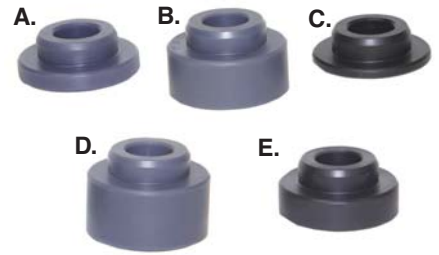

RRP HANDLEPOLE BUSHINGS

Sold in pairs.

Description	Part No.
A. RRP Yamaha SJ 96+ Cast Handlepole Bushing	BU-YAM
B. RRP Kawasaki SXR Cast Handlepole Bushing	BU-KAW
C. RRP Hydrospace Cast and Billet Handlepole Bushing	BU-HYDRO
D. RRP Kawasaki SXR Billet Handlepole Bushing	BU-BILLET-KAW
E. RRP Yamaha SJ96+ Billet Handlepole Bushing	BU-BILLET-YAM
RRP Yamaha SJ (95), FX-1 Cast Handlepole Bushing	BU-YAM-92-95



Installs on the RRP pivot bolt.

RRP HANDLEPOLE SPACER

For the rider that rides with a very tight pivot bolt. This spacer is designed to prevent failure of the RRP pole bottom piece.

If you use a RRP Spacer you can't use a handlepole spring.

Description	Part No.
RRP Cast Handlepole Spacer	AL-BP-SPC
RRP Billet Handlepole Spacer	AL-BP-SPC-B



BLOWSION CARBON CHIN PAD

Lightweight construction with unbreakable carbon construction. Fits 96+ Superjet, RRP and UMI 800SXR handlepole conversion systems. Chin Pad cover black top/black side only.

Description	Part No.
Blowsion Carbon Chin Pad	04-01-202

RIKTER RRP

RRP NINJA CHIN PAD

The new RRP Ninja design utilizes a new 3 bolt mounting system to avoid any steering system issues. This chin pad requires a RRP Universal Steering Stop based on the rear mounting location. Steering Stop part #ST-STOP-UNIV-COLOR (see page 81). RRP Ninja Chin Pads are compatible with all RRP Adjustable Handlepoles.

	WHITE BASE	BLACK BASE (CARBON LOOK)*
Yellow	RRP-NIN-PAD-WH/YW	RRP-NIN-PAD-BLK/YW
Green	RRP-NIN-PAD-WH/GN	RRP-NIN-PAD-BLK/GN
Red	RRP-NIN-PAD-WH/RD	RRP-NIN-PAD-BLK/RD
Blue	RRP-NIN-PAD-WH/BLU	RRP-NIN-PAD-BLK/BLU
Grey	NOT AVAILABLE	RRP-NIN-PAD-BLK/GREY
Orange	NOT AVAILABLE	RRP-NIN-PAD-BLK/ORG
White	NOT AVAILABLE	RRP-NIN-PAD-BLK/WH
Black	RRP-NIN-PAD-WH/BLK	NOT AVAILABLE

*These Ninja Chin Pads are "Carbon Look" not actual carbon fiber.



RRP-NIN-PAD-WH/GN



RRP-NIN-PAD-BLK/GN



RRP-NIN-PAD-BLK/RD



RRP-NIN-PAD-WH/RD



RRP-NIN-PAD-WH/BLU



RRP-NIN-PAD-BLK/BLU



RRP-NIN-PAD-BLK/ORG



RRP-NIN-PAD-BLK/GREY



RRP-NIN-PAD-BLK/WH



RRP-NIN-PAD-WH/BLK



RRP-NIN-PAD-WH/YW



RRP-NIN-PAD-BLK/YW

NEW

NEW

RRP CHIN PAD

These chin pads are the only chin pad that really matches the lines of a RRP handlepole. The design utilizes a front tongue mount and a two side rear mounting system to create a solid mounted chin pad. A RRP Universal Steering Stop is recommended. Steering Stop part #ST-STOP-UNIV-COLOR (see page 81). RRP Chin Pads are compatible with all RRP handlepoles.

	WHITE BASE	BLACK BASE (CARBON LOOK)*
Red	RRP-PAD-WH/RD	RRP-PAD-CB-L-RED
Blue	NOT AVAILABLE	RRP-PAD-CB-L-BLUE
Rickter	RRP-PAD-RICKTER-WH	RRP-PAD-RICKTER-RED
XFS	RRP-PAD-XFS-WHITE	NOT AVAILABLE

*These RRP Chin Pads are "Carbon Look" not actual carbon fiber.
Limited supply available



RRP-PAD-CB-L-BLUE



RRP-PAD-WH/RD



RRP-PAD-XFS-WHITE



RRP-PAD-RICKTER-RED



RRP-PAD-RICKTER-WH



RRP-PAD-CB-L-RED

FREESTYLE
FREERIDE

INTAKE
SYSTEMS

ENGINE/
GASKETS

EXHAUST

DRIVE LINE
HANDLING

ELECTRICAL

WATERLINE
/BILGE

STEERING
& CONTROLS

BODY

ACCESSORIES
/HARDWARE

SERVICE TOOLS

CHEMICAL



New Updated Fat Bar Steering Systems

The RRP fat bar steering systems have been updated for 2016 to have the RRP short base clamp (SH-BASE-CLP-BLK) included in the system which moves the rider forward 7/8" closer to the pivot bolt compared to RRP earlier systems.

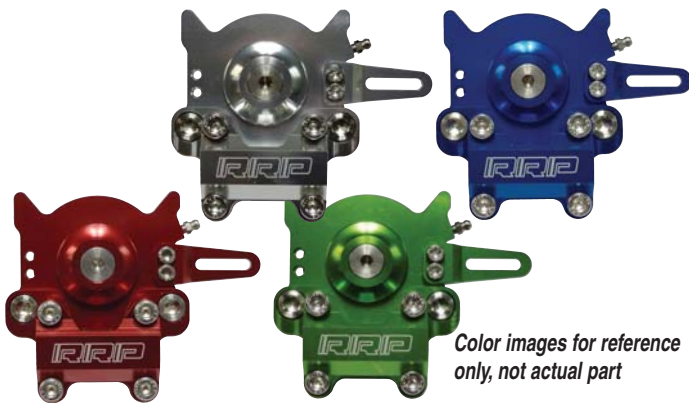

Color images for reference only, not actual part

RRP AST STEERING SYSTEM FOR 28.6MM FAT BARS

This RRP AST (Advanced Steering Technology) steering system has been designed for all types of riding from Freestyle to racing and from freeride to the recreational rider. Each rider will find benefits in this concept.

The concept behind this steering system has many features:

- To bring the rider closer to the pivot point
- Less movement to turn the bars (quicker steering ratio)
- Lowers the center of gravity
- Multiple bar position allowing the rider to perfect their riding style
- Fits all stand up watercraft due to the movable steering cable arm
- Slotted steering arm allows for extremely precise steering ratio adjustments
- Utilizes the fat bar 28.6 mm technology for better clamping surface
- The system uses bearings and is o-ring sealed
- Grease Zerk fitting to grease the bearing system for easy maintenance
- 100% Compatible with all RRP carbon chin pads

Description	Color	Part No.
RRP AST Steering System	Black	STR-SYST-UNI-F-BLK-S
RRP AST Steering System	Red	STR-SYST-UNI-F-RD-S
RRP AST Steering System	Silver	STR-SYST-UNI-F-SLV-S
RRP AST Steering System	Green	STR-SYST-UNI-F-GN-S
RRP AST Steering System	Blue	STR-SYST-UNI-F-BLU-S



AST-PAD-RD



AST-PAD-BLK

RRP AST PAD

RRP AST Pad was developed for use on the RRP Fat Bar Steering Systems based on Fat Handlebars do not have a cross bar and pad. These pads are required by the IJSBA for all racing and freestyle classes (IJSBA rule book • handle bar mount padding mandate in the stock class rule # 6.2.9)

Description	Color	Part No.
AST Protective Pad	Red	AST-PAD-RD
AST Protective Pad	Grey	AST-PAD-BLK



The RRP Short base clamp utilizes a center mounting hole
Handlebars are 1" from the pivot

RRP SHORT BASE CLAMP

RRP Fat Bar Steering Systems (STR-SYST-UNIV-F-COLOR) manufactured in 2015 and earlier were made with the extended base clamp shown below, this short clamp will move the handlebars 7/8" closer to the pivot point.

Description	Color	Part No.
RRP Shortened Base Clamp	Black	SH-BASE-CLP-BLK
RRP Shortened Base Clamp	Red	SH-BASE-CLP-RED
RRP Shortened Base Clamp	Blue	SH-BASE-CLP-BLU
RRP Shortened Base Clamp	Green	SH-BASE-CLP-GN



The RRP Extended base clamp utilizes an end mounting hole
Handlebars are 1 7/8" from the pivot

RRP EXTENDED BASE CLAMP

RRP Fat Bar Steering Systems (STR-SYST-UNI-F-COLOR-S) manufactured in 2016 are now made with the short base clamp shown above, this extended clamp will move the handlebars 7/8" away from the pivot point.

Description	Color	Part No.
RRP Extended Base Clamp	Black	EXT-BASE-CLP-BLK
RRP Extended Base Clamp	Red	EXT-BASE-CLP-RED
RRP Extended Base Clamp	Blue	EXT-BASE-CLP-BLU
RRP Extended Base Clamp	Green	EXT-BASE-CLP-GN



F.



G.

RRP BEARING AND O-RING REPAIR KIT FOR AST & UNIVERSAL STEERING SYSTEM

Description	Part No.
F. RRP Bearing and O-ring Repair Kit	SS-B
G. RRP O-Ring Repair Kit	SS-O



RRP UNIVERSAL STEERING SYSTEM

RRP has revised the RRP Universal Steering System and RRP Turnplate previously sold separately. This new and improved system will now be sold as a complete kit like the RRP AST Fat Bar Steering System. The turn plate has been shortened to move the rider closer to the pivot point and to create a more comfortable and improved steering system, eliminates steering slop, features an integrated grease fitting to maintain optimum lubrication and is much stronger than the OEM steering systems on standup watercraft. This kit will fit both RRP Straight (22.2mm) and aftermarket (V Bend) handlebars that are standard 22.2mm clamp compatible.

This system is not compatible with any other standard 22.2mm handlebar steering turnplates due to the stem/steering system pivot is larger than previous models.

Description	Color	Part No.
RRP Univ. Steering System	Black	STR-SYS-UNIV-KIT-BLK
RRP Univ. Steering System	Silver	STR-SYS-UNIV-KIT-SLV
RRP Straight Bars (22.2mm Clamping Surface)		ST-B
RRP Bearing and O-ring Repair Kit		SS-B
RRP O-Ring Repair Kit		SS-O



RRP HANDLEBAR EXTENDERS

Extend the width our your handlebars up to 4 inches (2" per side) with these simple and easy to install handlebar extenders.

Description	Part No.
RRP Handlebar Extenders	BAR-END-EX

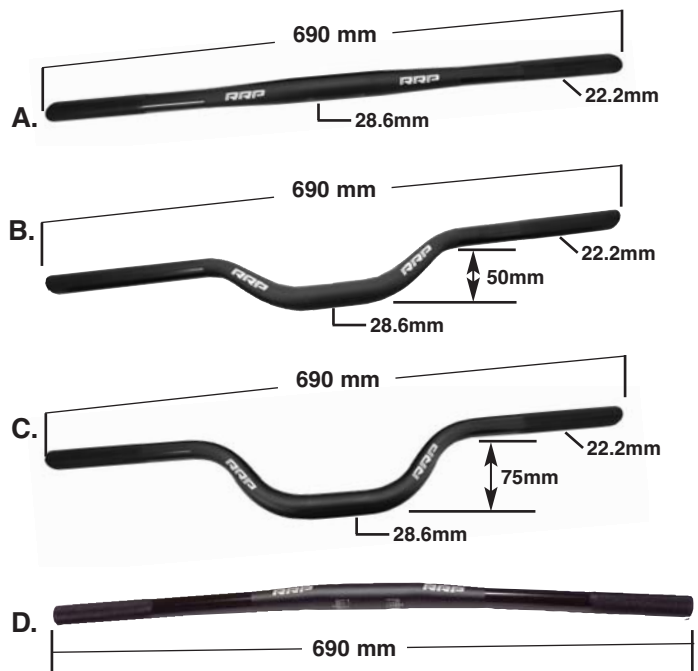

RRP "FAT" HANDLEBARS

RRP has developed these "Fat" bars (28.6mm clamping surface) to be extremely strong for freestyle, freeriding and racing.

Description	Part No.
A. RRP Straight Fat (28.6mm) Bars (690mm Length)	ST-B-F
B. RRP 50mm Fat (28.6mm) Bars (690mm Length)	50-B-F
C. RRP 75mm Fat (28.6mm) Bars (690mm Length)	75-B-F
D. RRP 4 Degree Racing Fat (28.6mm) Bars (690mm Length)	4DEG-B-F



RRP CHIN PAD SUPPORT & STEERING STOP

This steering stopper will also prevent the pole pad from crushing or getting ripped out from the handlepole. New universal design fits both RRP and SuperJet style chin pads.

Description	Color	Part No.
RRP Chin Pad Support & Steering Stop	Black	ST-STOP-UNIV-BLK
RRP Chin Pad Support & Steering Stop	Red	ST-STOP-UNIV-RD
RRP Chin Pad Support & Steering Stop	Green	ST-STOP-UNIV-GN
RRP Chin Pad Support & Steering Stop	Blue	ST-STOP-UNIV-BLU

FREESTYLE FREERIDE	INTAKE SYSTEMS	ENGINE/ GASKETS	EXHAUST	DRIVE LINE HANDLING	ELECTRICAL	WATERLINE /BLIGE	STEERING & CONTROLS	BODY	ACCESSORIES SERVICE TOOLS /HARDWARE	CHEMICAL
-------------------------------	---------------------------	----------------------------	----------------	--------------------------------	-------------------	-----------------------------	------------------------------------	-------------	--	-----------------

**FREESTYLE
FREERIDE**
**INTAKE
SYSTEMS**
**ENGINE/
GASKETS**
EXHAUST
**DRIVE LINE
HANDLING**
ELECTRICAL
**WATERLINE
/BILGE**
**STEERING
& CONTROLS**
BODY
**SERVICE TOOLS
ACCESSORIES**
CHEMICAL

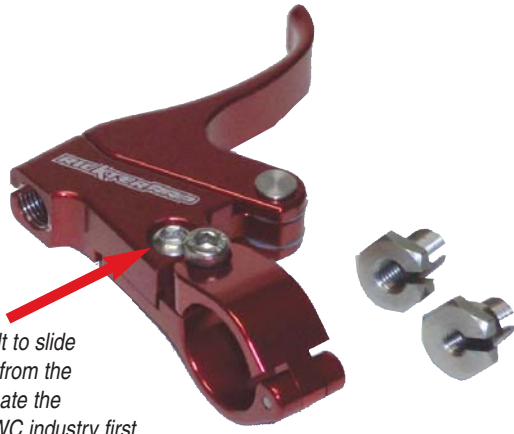

Loosen this bolt to slide the lever away from the grip/bars to create the perfect fit, a PWC industry first



RRP ADJUSTABLE THROTTLE LEVER

This lever is the first adjustable offered that allows you to adjust the distance of the finger lever to the grips/bars in a second to fit the rider's finger size. Everyone has a preference when it comes to throttle finger, hand size is also a factor, that's why RRP designed one that can fit everyone. Ergonomically designed to give the rider a good grip and good feeling. Comes with Yamaha and Kawasaki stainless steel cable adaptors.

Description	Part No.
Green	RRP-TH-LEVER-GN
Red	RRP-TH-LEVER-RD
Black	RRP-TH-LEVER-BLK
Blue	RRP-TH-LEVER-BLU



RRP NINJA PUMP FLOW GUARD

The RRP Ninja Flow Guard is a performance part that was designed by Hiro "Ninja" Ogino in Japan specifically for freestyle watercraft applications.

- Prevents water from entering the pump between the restriction nozzle and steering nozzle which disrupts the flow water inside of the pump. Result: Loss of power
 - Prevents back spray when turning the steering nozzle and loss of internal pump pressure. Result: Gain of power
 - Stops the pumps to spray into the exhaust causing engine bog on acceleration during turning and maneuvers. Result: Gain of power
- Tested and approved by Rick Roy, Rok Florjancik and Nac Florjancik.

144 MM Pump	Part No.
Carbon - 144 Yamaha	FL-GD-NIN1-CB (144-YAM)

155 MM Pump	Part No.
Carbon - 155 Yamaha	FL-GD-NIN1-CB (155-YAM)
Fiberglass -Black 155 Yamaha	FL-GD-NIN1-F-BLK (155-YAM)



RRP TRIM SYSTEM

The RRP trim system is a super easy top pull trim system and was designed to be effortless and allowing for better rider control during maneuvers and tricks. The trim design features increased water

flow while minimizing pressure loss during turning and trimming, this was achieved with a all new trim ring design that features a tight clearance between the exit nozzle, the trim ring and the steering nozzle. The top pull mounting point on the trim ring is slotted to adjust the amount of trim the rider desires and creates the perfect rider feel.

Kit includes: reduction nozzle, steering nozzle, trim ring, cable, billet RRP lever and hardware. RRP trims are manufactured with thick exit and steering nozzles to allow for boring to larger sizes.

144mm	Part No.
Green	RRP-TRIM-144-GN
Silver	RRP-TRIM-144-SLV
Red	RRP-TRIM-144-RD
Black	RRP-TRIM-144-BLK
Blue	RRP-TRIM-144-BLU

155mm	Part No.
Green	RRP-TRIM-155-GN
Silver	RRP-TRIM-155-SLV
Red	RRP-TRIM-155-RD
Black	RRP-TRIM-155-BLK
Blue	RRP-TRIM-155-BLU

RRP TRIM SYSTEM REPLACEMENT PARTS

Description	Part No.
RRP Trim Cable	RRP-TRIM-CABLE
144mm Steering Nozzle	RRP-TRIM-NOZ-144
155mm Steering Nozzle	RRP-TRIM-NOZ-155



RRP BILLET TRIM LEVER

Rick Roy tried and tested many shapes and styles of trim levers to suit the extreme riders' needs. Produced from CNC machined 6061 T6 Aluminum. Ergonomically designed to fit the rider's fingers and also to give maximum pull on the cable. Trim cable adjuster is included.

Description	Part No.
Green	RRP-TRIM-LEVER-GN
Red	RRP-TRIM-LEVER-RD
Black	RRP-TRIM-LEVER-BLK
Blue	RRP-TRIM-LEVER-BLU

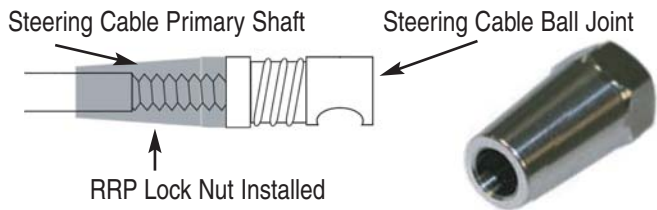

RRP STEERING CABLE STRENGTHENING LOCK NUT

Are you tired of breaking steering cables? The RRP design moves the load on your steering cable from the threaded part of the cable to the main smooth part of your steering cable where it has more strength. RRP recommend you put these on both the pump end and the steering end of the cable for maximum protection. Sold Individually.

Description	Part No.
Lock Nut For 5mm Cable (Stock Cable)	RRP-SC-STN-5MM
Lock Nut For 6mm Cable (Blowsion, Skat-Trak and OEM 6mm Steering Cables)	RRP-SC-STN-6MM



RRP YAMAHA QUICK STEERING ADAPTER

This quick steering adapter fits the stock superjet nozzle. It will give you the option to adjust with the quickness of the steering from really aggressive to really smooth. It will also give you a lot more turning ratio for free style. Color: Black

Description	Part No.
RRP Yamaha Quick Steering Adapter	QU-ST-YAM



RICKTER PUMP SHOE

The RRP 155 pump shoe is CNC machined to create a great fitting and easily installed pump shoe. The pump shoe lip has been increased to create an extra large sealing area and boring to handle the biggest pumps on the market. Intake grate mounting holes are not predrilled on the 155 pumps shoe, this allows for the shoe to be placed exactly

where you need it with out creating a intake grate mounting/installation issue. The RRP 144 shoe is a direct OEM replacement plastic shoe.

Description	Material	Part No.
Rickter Pump Shoe 155mm	Aluminum	PM-SH-AL-155
Rickter Pump Shoe 144mm	Plastic	PM-SH-PLAS-144

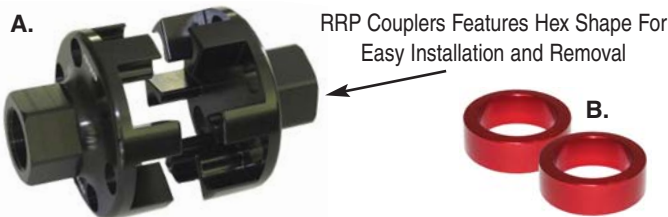

RRP ENGINE COUPLER AND SPACERS

Description	Part No.
A. RRP Aluminum Engine Coupler Set (Black)	RRP-EG-CPL
B. RRP Coupler Spacer (Red & sold in pairs)	CPL-SPC
RRP Coupler Dampener (Not pictured)	RRP-EG-DAMP



RICKTER ENGINE PLATE

RRP engine plates are sold in pairs, no hardware included.

Description	Part No.
Aluminum Adjustable Engine Plate - Red	ADJ-ENG-PLT
Aluminum Adjustable Engine Plate - Black	ADJ-ENG-PLT-BLK



C. *Fuel pumps are not included

D.



E.

F.

RRP/RICKTER CARBON ACCESSORIES

Description	Part No.
C. RRP Ninja Carbon fiber Gas Plate	NINJA-GAS-PLT-CB
D. RRP Ninja Carbon fiber Hood Air Scoop	NJ-HOOD-SC
E. RRP Carbon fiber Electric Plate for MSD Total Loss Component (2 Piece)	EL-PLT-MSD
F. RRP Carbon fiber Yamaha Electric Plate (Glue on Side of Wall of Hull)	EL-PLT-YAM



RRP ALUMINUM ELECTRIC BOX

Designed specifically for the MSD Total Loss Kit Part# 42380 (page 218)

Description	Color	Part No.
RRP Alum. Electric Box	Black	RRP-AL-EL-BOX-BLK
RRP Replacement Cover	Clear Lexan	RRP-AL-EL-BOX-CVR
RRP Replacement O-ring	-----	RRP-AL-EL-BOX-ORING



RICKTER FLYWHEEL COVER

Description	Part No.
Rickter Yamaha Flywheel Cover (Red)	RICKTER-FW-CVR

FREESTYLE
FREERIDE

INTAKE
SYSTEMS

ENGINE/
GASKETS

EXHAUST

DRIVE LINE
HANDLING

ELECTRICAL

WATERLINE
/BLIGE

STEERING
& CONTROLS

BODY

ACCESSORIES

SERVICE TOOLS
/HARDWARE

CHEMICAL

**FREESTYLE
FREERIDE**

**INTAKE
SYSTEMS**

**ENGINE/
GASKETS**

EXHAUST

**DRIVE LINE
HANDLING**

ELECTRICAL

**WATERLINE
/BILGE**

**STEERING
& CONTROLS**

BODY

**SERVICE TOOLS
ACCESSORIES**

**SERVICE TOOLS
/HARDWARE**

CHEMICAL



RRP ADJUSTABLE BINDING SYSTEM

The RRP AB (Adjustable Binding) System is the industry leading and revolutionary binding system and was developed for the Rickter Hulls.

This system allows you install the RRP Adjustable Binding System on any SuperJet with a limited amount of modifications.

The systems features the ability to move the bindings both vertically and horizontally to achieve that perfect position for the rider.

This system is a must for any freestyle or freerider.

Description	Part No.
A-1. RRP Adjustable Binding System to Install on SuperJet	RRP-AB-SYST
A-2. RRP AB Binding Only (sold in pairs)	AB-BINDING
B-1. RRP Ninja Complete Adjustable Binding System to Install on SuperJet	RRP-AB-SYST-NINJA
B-2. RRP AB Ninja Binding • Fiberglass (sold in pairs) No Hardware Included	AB-NINJA-F
B-2. RRP AB Ninja Binding • Carbon Fiber (sold in pairs) No Hardware Included	AB-NINJA-CB
C. RRP AB Foot Plate Kit (Aluminum)-Red (sold in pairs) No Hardware Included	AB-F-PLT-RD
C-2. RRP AB Foot Plate Kit (Aluminum)-Black (sold in pairs) No Hardware Included	AB-F-PLT-BLK
D. RRP AB Exterior Plastic Washer (sold individually)	AB-PL-WSH
E. RRP Version 2* (Small) AB Foot Plate Kit (Aluminum)-Black (sold in pairs) No Hardware Included *Version 2 Plates fit: 2015-2016 XFS, 2015-2016 XFS Competition, 2016 XFR, 2016 XFR LT	AB-F-PLT2-BLK



RRP RICKTER SCUPPER VALVE

Description	Part No.
F. RRP Rickter Scupper Valve	RRP-SCU-V
G. RRP Rickter Replacement Scupper Flap	RRP-SCU-V-FLAP



RRP REAR FUEL TANK, HOOK & FUEL FILLER

Description	Part No.
H. RRP Rear Fuel Tank Only-Black All Rickter & SuperJet Models - tank capacity 1.5 US gallons	RRP-RFL-TK-BLK
I. RRP Replacement Fuel Line and Vent Fitting with Grommet (Fitting Anodized Red)	FU-LI-FIT
J-1. Fuel Tank/Battery/Water Box Hook - Red	AL-HOOK-A-RD
J-2. Fuel Tank/Battery/Water Box Hook - Black	AL-HOOK-A-BLK
K. Billet Internal Fuel Filler with Cap - Red *Includes Rubber Block-off Cap for Yamaha Superjet Fuel Tank	RRP-YIFF-DI

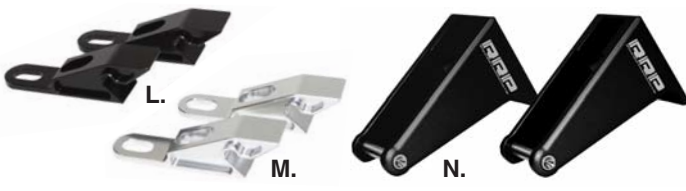

RRP BILLET HOOD CLIPS AND HOOD PRONGS

RRP hood clips and prongs are sold in pairs.

Description	Part No.
L. Yamaha Billet Hood Clip - Black	BL-HC-YAM
M. Yamaha Billet Hood Clip - Silver	BL-HC-YAM-SLV
N. Rickter & Yamaha Hood Prong - Black Rickter Billet Hood Clip - Black (Not pictured)	RKT-HD-FRK-BLK BL-HC-RICKTER-BLK



RRP BILLET HOOD LATCH

The new RRP Billet adjustable hood latch is extremely strong and allows you to adjust the amount of pressure on the hood seal in seconds, thus ensuring your ski always has a tight seal.

Description	Part No.
RRP Adjustable Hood Latch - Black	RRP-HOOD-LATCH-BLK
RRP Adjustable Hood Latch - Red	RRP-HOOD-LATCH-RD
RRP Adjustable Hood Latch - Blue	RRP-HOOD-LATCH-BLU
RRP Adjustable Hood Latch - Green	RRP-HOOD-LATCH-GN



RRP WATER FITTINGS

RRP water fitting and manufactured using Delrin and is the only aftermarket water fitting that will not corrode and jam along with they are lightest fittings available in the PWC Industry.

Description	Material	Part No.
A. 3/4" Bilge Outlet - 45 Degree	Delrin Black	PL-45-BILGE
B. 1/2" Bypass Outlet - 45 Degree	Delrin Black	PL-1/2 OUT
C. 3/8" Bypass Outlet - 45 Degree	Delrin Black	PL-3/8-OUT

Description	Material	Part No.
D. 1/8" NPT to 3/8" Barb	Aluminum-Black	90-1/8-NPT-BLK
E. 1/8" NPT to 3/8" Barb	Aluminum-Red	90-1/8-NPT-RED



RICKTER HULL HOOD SEAL

Fits all Rickter models.

Description	Part No.
Hood Seal for Rickter Hulls - 2.5 meters	RRP-HD-SCL



RICKTER HOOD PAD

Description	Part No.
Rickter Hood Pad - Black	RKT-HD-PAD-BLK



RICKTER LIFE JACKET BLACK

Rickter wetsuits, tour coats and life jackets are manufactured by Jet Pilot.

Description	Part No.
Life Jacket Black - Small/Medium	RKT-LFJ-RD-S/M
Life Jacket Black - Large/Extra Large	RKT-LFJ-RD-L/XL

Rickter wetsuits and life jackets will be discontinued once sold out.



**NEW
UPDATED DESIGN**

RICKTER T-SHIRT, HOODIES & CAP

T-Shirt (2016 Design)	Part No.	Hoodies (2016 Design)	Part No.
Small	RKT-TS-BLK-S	Small	RKT-HDI-BLK-S
Medium	RKT-TS-BLK-M	Medium	RKT-HDI-BLK-M
Large	RKT-TS-BLK-L	Large	RKT-HDI-BLK-L
X-Large	RKT-TS-BLK-XL	X-Large	RKT-HDI-BLK-XL

Caps	Part No.	Mesh Cap (2016 Design)	Part No.
Medium	RKT-FF-HAT-BLK-M	One Size	RKT-LM-HAT
Large	RKT-FF-HAT-BLK-L	Fits All Mesh Cap	

2014 RICKTER WET SUIT RED

Rickter wetsuits, tour coats and life jackets are manufactured by Jet Pilot.



Description	Part No.
Race John and Jacket Black - Large	RKT-JJ-RD-L
Race John and Jacket Black - Extra Large	RKT-JJ-RD-XL

Rickter wetsuits and life jackets will be discontinued once sold out.



RICKTER TOUR COAT

Rickter wetsuits, tour coats and life jackets are manufactured by Jet Pilot.

Description	Part No.
Tour Coat-Small	RKT-TCOAT-S
Tour Coat-Extra Large	RKT-TCOAT-XL



Full Finger Glove



Phantom Glove

JET PILOT GLOVES

Glove:	Color:	Type:
Full Finger Glove	Black/White	Thick
Phantom Glove	Black/White	Lightweight - Thin

Full Finger Glove	Part No.	Phantom Glove	Part No.
Small	JP-FFG-BLK-S	Small	JP-PHG-BLK/WH-S
Medium	JP-FFG-BLK-M	Medium	JP-PHG-BLK/WH-M
Extra Large	JP-FFG-BLK-XL		

**FREESTYLE
FREERIDE**

**INTAKE
SYSTEMS**

**ENGINE/
GASKETS**

EXHAUST

**DRIVE LINE
HANDLING**

ELECTRICAL

**WATERLINE
/BILGE**

**STEERING
& CONTROLS**

BODY

ACCESSORIES

**SERVICE TOOLS
/HARDWARE**

CHEMICAL

RICKTER

2016 Models

XFR **XFR-U**



Fiber - Black Base, Carbon Look or 100% Carbon



EDGE FS-FR



Fiber - White Base



Carbon Look or 100% Carbon

**TRASH
LOOK**



EDGE FS-FR



Fiber - White Base



Carbon Look or 100% Carbon

**CLASSIC
LOOK**



XFS

XFS



100% Carbon



Fiber - Black Base, Carbon Look or 100% Carbon



RICKTER HULLS

Rickter hulls and parts are the premier products for the aftermarket PWC industry, the quality, fit, finish and performance is superior to any other aftermarket brand available. All Rickter hulls and parts are manufactured to the high standards and tolerances at the Rickter Factory located in Thailand under the direction and guidance of Rick Roy the founder of RRP (Rick Roy Products).

Based on the great success and sales of all the RRP products, Rick utilized this success and momentum to take the next step in his PWC manufacturing career. He followed his dream and vision to create and produce the most fun stand up ski. Rick's 20+ years of competing, riding, R&D, manufacturing and teaching, along with his knowledge and information about what it takes to make a great hull, he created the Rickter hull.

Since the first Rickter was produced the Rickter hull development and production has evolved into a hull line that has over 15 different models that allows the rider play at the lake, carve buoys, rip flat water freestyle, Rickter has by far the most overall and versatile hull line available in the aftermarket PWC hull industry.

Rickter hulls are not just for the Pro Rider and competition, they are great hulls for the all-around riders all the way to a beginner.

The 2016 Models are:

- Edge FS
- Edge FR
- XFS
- XFR
- XFR-LT
- XFS NINJA Competition
- RC-1

Rickter offers all of the previous production models on a special order basis.

Rickter hulls are offered in fiberglass, carbon look, carbon fiber and the new TeXtreme® carbon fiber.

Rickter hulls come with "Classic Rickter" graphics are available in 5 colors. The Rickter Edge is available in the "Classic Rickter" and the Rickter "Trash Style" graphics along with the choice of the 5 colors.



Please visit www.RickRoy.com for most up to date information and details on all of the Rickter Products available.

STANDARD EQUIPMENT ON RICKTER HULLS



RRP Handle Pole Bracket & Hood Hook



RRP Handlepole Pad



XFS Ninja Adj. Binding
Optional for other models



RRP Adjustable Binding System



Rickter Turf Kit



RRP Adjustable Engine Mount



RRP Adjustable Engine Mount



RRP Hood Seal



RRP XFS Competition Pole Bracket & Hood Hooks



RRP Scupper Valve



Fully Painted & Rickter Graphics Applied

RICKTER INTAKE GRATES

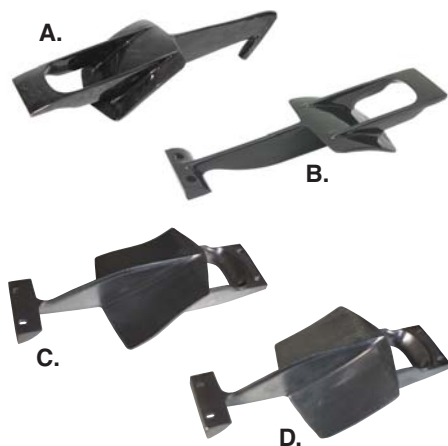

Rickter Intake Grate	Part No.
A. Full Carbon (Hook Style)	INT-GR-NIN1-CB
B. Full Carbon (Wing Trim)	INT-GR-NIN2-CB
C. Aluminum (Wing Trim)	INT-GR-AL
D. Aluminum (Wing Untrim)	INT-GR-AL-UN

Supplied with an untrimmed wing to allow the rider the ability to customize the intake grate.

RICKTER RIDE PLATES

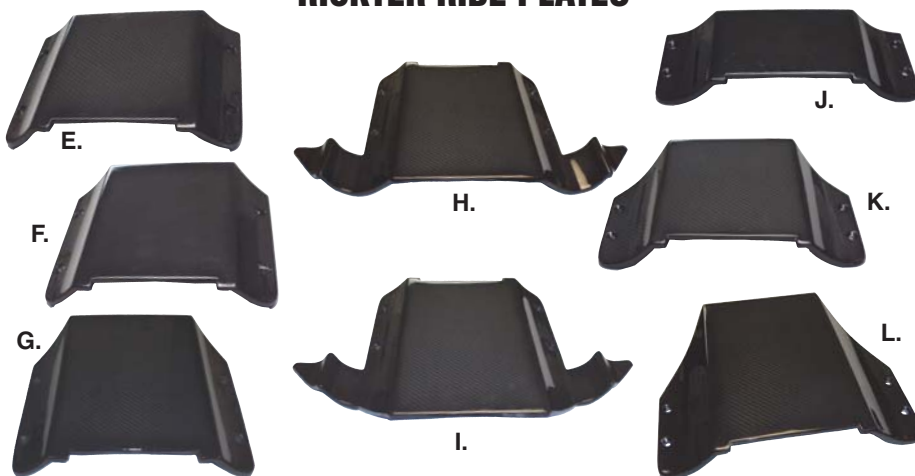

FS/FR and EVO	Part No.	XFS/XFR/XFS Ninja Competition (2015 and Earlier)	Part No.
Short	FS-2-RD-PLT-S	Short	XFS/XFR-RD-PLT-S
Medium	FS-2-RD-PLT-M	Medium	XFS/XFR-RD-PLT-M
EDGE	Part No.	XFS/XFR/XFS Competition (2016)	Part No.
E. Short	EDGE-RD-PLT-S	J. Short	XFS2-RD-PLT-S
F. Medium	EDGE-RD-PLT-M	K. Medium	XFS2-RD-PLT-M
G. Long	EDGE-RD-PLT-L	L. Long	XFS2-RD-PLT-L
H. Bat Wing - Long	EDGE-RD-BPL-L		
I. Bat Wing - X-Long	EDGE-RD-BPL-XL		

FREESTYLE
FREERIDE

INTAKE
SYSTEMS

ENGINE/
GASKETS

EXHAUST

DRIVE LINE
HANDLING

ELECTRICAL

WATERLINE
/BILGE

STEERING
& CONTROLS

BODY

SERVICE TOOLS
ACCESSORIES

SERVICE TOOLS
/HARDWARE

CHEMICAL

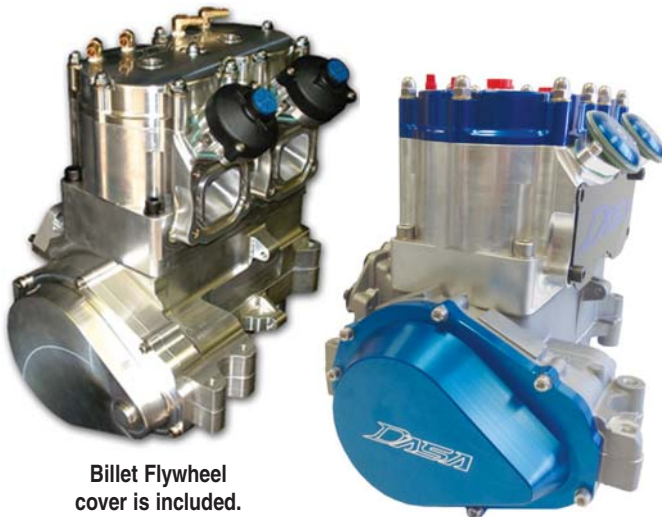

Billet Flywheel cover is included.

DASA COMPLETE ENGINE

Contains: cylinder kit, cylinder porting, crankcase (stock or billet), stroker case plate, crankshaft (hot rod or billet), OEM crank seals, all hardware and seals.

Engine CC	Piston Size	Crank Stroke	Crank	Engine Cases	Part No.
772cc	85mm	Stock	Hot Rods	Stock	WCE-SS85
846cc	89mm	Stock	Hot Rods	Stock	WCE-SS89
828cc	85mm	5mm	Billet	Stock	WCE-0585
840cc	85mm	6mm	Billet	Stock	WCE-0685
863cc	85mm	8mm	Billet	Stock	WCE-0885
863cc	85mm	8mm	Forged	Stock	WCE-0885F
885cc	85mm	10mm	Billet	Stock	WCE-1085
885cc	85mm	10mm	Forged	Stock	WCE-1085F
901cc	85mm	12mm	Billet	Stock	WCE-1285
920cc	89mm	6mm	Billet	Stock	WCE-0689
945cc	89mm	8mm	Billet	Stock	WCE-0889
945cc	89mm	8mm	Forged	Stock	WCE-0889F
970cc	89mm	10mm	Billet	Stock	WCE-1089
970cc	89mm	10mm	Forged	Stock	WCE-1089F
995cc	89mm	12mm	Billet	Stock	WCE-1289
1045cc	89mm	16mm	Billet	Billet	WCE-1689
1198cc	94mm	16mm	Billet	Billet	WCE-1694

Dasa Standard Recommended Engine Configurations



DASA BILLET STROKER CRANKSHAFT

Description	Part No.
5mm Billet Stroker Crankshaft	WC-0530
6mm Billet Stroker Crankshaft	WC-0630
8mm Billet Stroker Crankshaft	WC-0830
10mm Billet Stroker Crankshaft	WC-1030
12mm Billet Stroker Crankshaft	WC-1230
16mm Billet Stroker Crankshaft	WC-1630



Stroke Size	Piston Size					
	85mm	89mm	90mm	91mm	94mm	95mm
Stock Stroke	772cc	846cc	865cc	885cc	944cc	964cc
5mm	828cc	N/A	N/A	N/A	N/A	N/A
6mm	840cc	920cc	941cc	963cc	1027cc	1050cc
8mm	863cc	945cc	967cc	988cc	1055cc	1077cc
10mm	885cc	970cc	992cc	1014cc	1082cc	1105cc
12mm	901cc	995cc	1018cc	1040cc	1100cc	1135cc
16mm	N/A	1045cc	1069cc	1093cc	1165cc	1190cc



DASA PISTON KITS

The Wiseco Pistons are custom made for Dasa Racing to their proprietary specifications. All pistons are sold individually.

Flat Top Pistons	Part No.	Piston Kits	Part No.
85mm	WC-8500	89mm	WC-8900
85.50mm	WC-8550	89.50mm	WC-8950
86mm	WC-8600	90mm	WC-9000
86.50mm	WC-8650	90.50mm	WC-9050
		91mm	WC-9100
		94mm	WC-9400
		95mm	WC-9500

DASA PISTON PARTS

Below is a Dasa Piston parts reference chart, when ordering pistons you must use the Dasa part number (Wiseco No. is for reference only)

Dasa Part#	Size	Wiseco No.	Ring	Circlips	Wrist Pin	Bearings
WC-8500	85mm	11455M08500	3347KC	CW20*	S650	50-3302
WC-8550	85.5mm	11455M08550	3367KA	CW20*	S650	50-3302
WC-8600	86mm	11455M08600	3385KA	CW20*	S650	50-3302
WC-8650	86.5mm	11455M08650	3405KD	CW20*	S650	50-3302
WC-8900	89mm	11066M08900	3504TD	CW20*	S512	B1004
WC-8950	89.5mm	11066M08950	3524TD	CW20*	S512	B1004
WC-9000	90mm	11066M09000	3544TD	CW20*	S512	B1004
WC-9050	90.5mm	871M09050	3564KD	CW20*	S512	B1004
WC-9100	91mm	871M09100	3584KD	CW20*	S512	B1004
WC-9400	94mm	11896M09403	3701KD	CW20*	S512	B1004
WC-9500	95mm	11896M09508	3740KD	CW20*	S512	B1004

*Note: Part # CW20 is sold in pairs (2 per part number)



DASA CYLINDER KITS

DASA Cylinder Kits are supplied ported, ready to assemble and include:

- Power Valve Cylinder • Head & Domes • Complete Power Valve Assembly • Pistons
- All Necessary Hardware, Gaskets & O-rings



85mm Cylinder Kit	Part No.	89mm Cylinder Kit	Part No.	94mm Cylinder Kit	Part No.
Stock Stroke	WC-SS85	Stock Stroke	WC-SS89	Stock Stroke	WC-SS94
5mm Stroker	WC-0585	5mm Stroker	WC-0589	6mm Stroker	WC-0694
6mm Stroker	WC-0685	6mm Stroker	WC-0689	8mm Stroker	WC-0894
8mm Stroker	WC-0885	8mm Stroker	WC-0889	10mm Stroker	WC-1094
10mm Stroker	WC-1085	10mm Stroker	WC-1089	12mm Stroker	WC-1294
		12mm Stroker	WC-1289	16mm Stroker	WC-1694
		16mm Stroker	WC-1689		

DASA DOMES



7 Port Cylinder Dome	Part No.	5 Port Cylinder Dome	Part No.	5 Port Cylinder Dome	Part No.
85mm Flat Top Domes		89mm Domes		95mm Domes	
24cc Dome	WC-2485	37cc Dome	WC-3789	42cc Dome	WC-4295
26cc Dome	WC-2685	39cc Dome	WC-3989	44cc Dome	WC-4495
28cc Dome	WC-2885	42cc Dome	WC-4289	46cc Dome	WC-4695
30cc Dome	WC-3085	44cc Dome	WC-4489	48cc Dome	WC-4895
32cc Dome	WC-3285	46cc Dome	WC-4689	50cc Dome	WC-5095
34cc Dome	WC-3485	48cc Dome	WC-4889	*All domes are sold individually	
		50cc Dome	WC-5089		
		52cc Dome	WC-5289		



DASA SLEEVES

*All sleeves are sold individually

Description	Bore	Cylinder Ports	Part No.
Stock Stroke	85mm	7 Port	WC-1707
Stroker	85mm	7 Port	WC-1404
Stock Stroke	85mm	5 Port	WC-1811-S
Stock Stroke	89mm	5 Port	WC-1811
16mm Stroker	89mm	5 Port	WC-1811-16
Stock Stroke	94mm	5 Port	WC-1811-S-B
Stroker	94mm	5 Port	WC-1811-B
16mm Stroker	94mm	5 Port	WC-1811-16-B



DASA BILLET FLYWHEEL COVER

Flywheel O-ring kit is included with flywheel cover

Description	Part No.
Silver	FW-C701-SIL
Red	FW-C701-RED
Blue	FW-C701-BLU
Black	FW-C701-BLK
Green	FW-C701-GRN
Dark Gray	FW-C701-DGY
Replacement O-ring for Flywheel Cover	FW-ORING

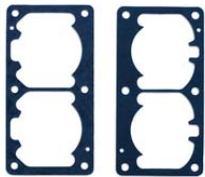

DASA CYLINDER BASE GASKETS

Base Gasket	Part No.
89mm-95mm 5 Port Cyl.	DL-003B
85mm-86.50mm 7 Port Cyl.	DL-004



DASA HEAD & DOME O-RING KITS

O-Ring Kit	Part No.
89mm-95mm 5 Port Cyl.	WC-7003
85mm-86.50mm 7 Port Cyl.	WC-7004



DASA CASE PLATE

Dasa stroker billet case reinforcement plate for 6mm to 12mm billet stroker crank applications.

Description	Part No.
Dasa Billet Case Plate	CP-7001



DASA CARBURETORS

See page 112 for more information



DASA INTAKE MANIFOLDS

See pages 114-115 for more information

**FREESTYLE
FREERIDE**

**INTAKE
SYSTEMS**

**ENGINE/
GASKETS**

EXHAUST

**DRIVE LINE
HANDLING**

ELECTRICAL

**WATERLINE
/BILGE**

**STEERING
& CONTROLS**

BODY

ACCESSORIES

**SERVICE TOOLS
/HARDWARE**

CHEMICAL

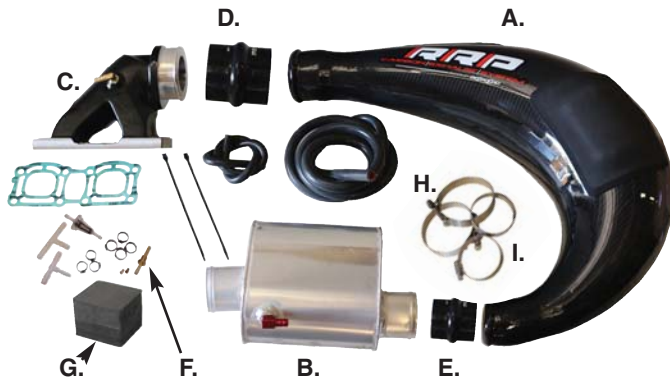

RRP NINJA CARBON FIBER EXHAUST SYSTEM

The RRP Ninja Carbon Fiber Exhaust System, by far the most innovative exhaust system on the market, this water injected system will give you explosive bottom end power and a huge power gains throughout the entire powerband.

This ultra-light carbon system is a huge weight savings compared to a regular dry pipe using a water jacket. A weight savings of appx 12lbs.

The carbon finish is second to none, Eva padding is included for durability and prevent any damage to the RRP Ninja carbon chamber.

This complete exhaust system features an innovative RRP water box that minimizes back pressure and features a 3/8" water input line allowing the waterbox temperature and exhaust noise be controlled.

RRP recommends this exhaust system for all Yamaha 701 2 Cylinder engine configurations from 850cc and up.

This RRP Ninja Carbon Fiber Exhaust System was a key factor in Rok Florjancik's Pro Freestyle World Championship at the 2012 Hot Products IJSBA World Finals.

Description	Part No.
RRP High Performance Complete Exhaust System for Yamaha Base 701 2 Cylinder Compatible Engine	RRP-CRB-PIPE

Individual Part	Part No.
A. RRP Carbon Exhaust Chamber	RRP-CRB-CHMB
B. RRP Aluminum Water Box	RRP-WTR-BOX
C. RRP Exhaust Manifold for Carbon Exhaust	RRP-EX-MLFD
D. RRP 3-1/2" Mnfld to Chmbr Hump Coupler	RRP-EX-CPL
E. RRP 2-1/2" Waterbox Hump Coupler	RRP-EX-CPL-WB
F. RRP Exhaust Water Injector Threaded for Mikuni High Jet	RRP-WTR-INJ
G. EVA Block 100mm x 120mm x130mm with Radius Corners for Carbon Pipe Seating	PIPE-BLOCK-EVA
H. RRP Exhaust Manifold to Chamber Clamp (1" wide by 3-1/2" diameter T-Bolt Clamp)	HOSE-CLMP-3.5
I. RRP Chamber to Waterbox Clamp (1" wide by 2-1/2" diameter Clamp)	HOSE-CLMP-2.5



POWERFACTOR YAMAHA FREESTYLE EXHAUST SYSTEM WITH POWER BOX

The ultimate freestyle exhaust system. Designed for flat water freestyle and free ride, the PFP exhaust optimizes the power band of most modified jet ski engines. The exhaust manifold bolts up to any Yamaha 701 exhaust bolt pattern. PFP also produces an adapter plate that bolts to any Polaris 700/800 exhaust pattern.

The PowerFactor dry exhaust, is designed so nothing interferes with the engines top end. This allows for any combination of top ends (Bore, Stroke, and Exhaust Valves, etc). It also allows easy access to engine components. The exhaust will fit most hulls, Yamaha SuperJet, Polaris Octane, XScream Hulls, Lenzi Hulls, RRP Hulls, and EME Hulls.

Chambers and manifolds are not sold separately. Chambers come in silver, no powder coating. If a customer would like their chamber painted black, a special request needs to be made and additional charges will apply.



Description	Part No.
PowerFactor Yamaha Freestyle Exhaust System with Power Box	PFPFINEXSJ1-WB
J. High Torque Hose Clamp & Hardware Kit	PFPCLPEXH03
K. Power Factor Power Box	PFPFINWB01
L. Power Factor Silicon Hose Kit	PFPHOSEXH04
M. Power Factor Exhaust Manifold	PFPEXMNFLD



BULLETT RACING CARBON FIBER NOSE COWL



Description	Part No.
Carbon Fiber Nose Cowl for 800 SXR & Bullett Hull	SXR-003



BULLETT RACING LIGHTWEIGHT SXR HOOD

Bullett's lightweight SXR hood is extremely strong and very durable all while coming in 12lbs lighter than a OEM Kawasaki SXR hood. The hood is predrilled for installation

of the OEM hardware and utilizes the OEM hood seal. Feature additional clearance for installation of a Factory Pipe. Gloss gel coated finish.

Description	Part No.
Lightweight SXR Hood-Black	HOOD-KB-BLK
Lightweight SXR Hood-White	HOOD-KB-WHT



BULLETT RACING CARBON FIBER RIDE PLATE

Bullett's ride plate will improve overall speed & handling of your water-craft making your riding experience the best possible. Carbon compressed molded to retain the plate shape and design and not bend like aluminum ride plates. Improves lean angle, straight line tracking and overall grip

Description	Part No.
800 SXR Carbon Fiber Ride Plate	RP-KAW
SuperJet 08+ Carbon Fiber Ride Plate	RP-YAM+08



BULLETT RACING BEARING KEEPER K1100/1200

Bullett Racing bearing keeper was designed for high RPM output 1100/1200 Kawasaki engines. The keeper is to keep the front bearing in place and not push out the front seal on the flywheel side of the cases.

Description	Part No.
Bearing Keeper K1100/1200	BUL-K1301

JETTRIM MAT SET

Description	Part No.
Bullett V2 Mat Set	B101
Bullett Hydrospace Mat Set	B102
Bullett Wave Blaster Mat Set	B103



BULLETT RACING V2 RACE HULL

The Bullett Racing V2 WideBoy Hull is the winningest hull in recent years, in just 4 years Bullett Racing has collected every championship that they have raced in. 3 Kings Cups, 8 World Titles, 4 US National Championships, 3 European Championships, and countless other series championships. Bullett Racing has proven time and time again that if you want to be on the podium you are going to need a Bullett Racing Race Hull. No internet propaganda just race proven results!! This hull was built around the intake system of this boat with no compromises in race conditions. Bullett Racing only uses the highest quality materials on the market; all of our composite products are built with AME 6000 Pure Epoxy Vinyl Ester resins. The hull comes with a composite deck and bottom, composite bulkhead, carbon fiber ride plate for rigidity and memory retention, Bullett racing proprietary intake tubes inside the hood, tucked high up in the hood making it the most water tight hood on the market. The hull also comes with bow eyes front and rear, 2.5 inch exhaust, hull extensions, bond flange wedges, steering cable tube, 2 each 1/2" water lines, 5/8" trim cables tube, motor mount holes pre-drilled for either 800 or 1100 motor configuration, and last of all the deck and bottom are glued together with a high strength bonding glue, and all hulls are pre-finished on the inside with white gel-coat and black splatter.

Includes: Top Deck, Bottom Hull, Hood, Carbon Nose Cowl, Carbon Hull Extensions, Ride Plate, Pump Shoe, Intake Grate, Drive Shaft, dual cooling lines, trim cable tube, 2.5" exhaust. Hulls are pre-drilled for Motor Mounts, Carrier Bearing, Pump, Gas Cap, Handle Pole Bracket, and drain plugs. Gas Tank and water box tabs are also installed.

Hull Options

Material Options: Fiberglass is with epoxy resin for weight saving is standard. Carbon Fiber is an option for an additional cost.

Color Options: Black and White Standard, Metal Flake Colors are option with an additional cost.

Graphics Included: The Bullett Racing Graphic kits are optional

Matting Included: Pre-Installed Jettrim Mats are optional

Intended Fuel Tank: Standard Kawasaki OEM SXR Fuel Tank

Intended Intake Grate: Bullett Racing Single bar intake grate

Intended Ride Plate: Bullett Racing Carbon Fiber Ride Plate

Scupper Valve: Pre-Drilled

Trim Tube: Yes

Number of Cooling Lines: 2

Exhaust Size: 2.5"

Description	Part No.
V2 Race Hull Wideboy Deck	BUL-K1102-2
X-2 Sport Hull with V2 Bottom	BUL-K1103-2
Hydrospace Hull w/ V2 Wideboy Molded Tubbies	BUL-H1101-2
Wave Blaster V2 Hull	BUL-K1105-2

* See page 330 for more information on V2 Blaster Hull and V2 Widebody Hydrospace Hull

ENGINE CONVERSION	1
INTAKE SYSTEMS	1
ENGINE/GASKETS	1
EXHAUST	1
DRIVE LINE HANDLING	1
ELECTRICAL	1
WATERLINE /BILGE	1
STEERING & CONTROLS	1
BODY	1
ACCESSORIES SERVICE TOOLS /HARDWARE	1
CHEMICAL	1



KAWASAKI 1100/1200 SXR CONVERSION



Kawasaki 1100 Non-Girdle Head



*Domes are sold separately, not included with the head shell.

Kawasaki 1100 Girdle Head & Girdle Kit



*Domes are sold separately, not included with the head shell.

ADA RACING KAWASAKI 1100 BILLET HEAD

All ADA Racing billet heads are made from 6061-T6 aluminum and CNC machined for consistency and performance. Anodized for protection against corrosion. All ADA Racing head shells include orings and brass fittings.

Description	Color	Part No.
K1100 Non-Girdle Billet Head Shell	Silver	KA900/1100
K1100 Non-Girdle Billet Head Shell	Black	KA900/1100-BLK
K1100 Girdle Billet Head Shell	Silver	KA1100M
K1100 Girdle Billet Head Shell	Black	KA1100M-BLK
K1100 Girdle Kit for KA1100M		KA1100G
K1100 22cc Dome (215 lbs. - 112 Octane) 82mm		KD1222
K1100 24cc Dome (200 lbs. - 108 Octane) 82mm		KD1224
K1100 26cc Dome (185 lbs. - 105 Octane) 82mm		KD1226
K1100 28cc Dome (170 lbs. - 95 Octane) 82mm		KD1228
K1100 30cc Dome (155 lbs. - 91 Octane) 82mm		KD1230
K1100 32cc Dome (145 lbs. - 89 Octane) 82mm		KD1232
K1100 O-Ring Kit		ORKITK1100

*All ADA Racing Domes are sold individually

Special Race Dome with a 3° squish angle and a wider squish band (closer to 50% of the bore size)

Description	Bore Size	Dome Size	Part No.
K1100 Race Dome	82mm	22cc	KD8222
K1100 Race Dome	82mm	24cc	KD8224
K1100 Race Dome	82mm	26cc	KD8226
K1100 Race Dome	82mm	28cc	KD8228
K1100 Race Dome	82mm	30cc	KD8230
K1100 Race Dome	82mm	32cc	KD8232
K1200 Race Dome	85mm	22cc	KD8522
K1200 Race Dome	85mm	24cc	KD8524
K1200 Race Dome	85mm	26cc	KD8526
K1200 Race Dome	85mm	28cc	KD8528
K1200 Race Dome	85mm	30cc	KD8530
K1200 Race Dome	85mm	32cc	KD8532



KAW 1100 BASE GASKETS

Solid aluminum core with high density fiber facing.

Kawasaki Base Basket	Thickness	Part No.
1100 Base	.025" - .64mm	7615.025
1100 Base	.030" - .75mm	7615.030
1100 Base	.040" - 1.00mm	7615.040
1100 Base	.050" - 1.25mm	7615.050
1100 Base	.060" - 1.50mm	7615.060
1100 Base	.065" - 1.65mm	7615.065



KOMMANDER KAW TRIPLE 1100/1200 HEAD

Billet Aluminum Head & Domes, Fits all 1100 triple Kawasaki motors. Kommander Industries billet aluminum domes are made for racing, utilizing custom dome architecture for maximum fuel burn and horsepower gains, these domes are ready for the races. Domes are sold individually.

Description	Part No.
Kommander 1100 Billet Girdle Head Black (O-Ring Kit and Two 90° Head Water Fittings Included)	KOM-110-GZXI
Kommander 1100 Billet Head O-Ring Kit	KOM-110-O-RING
Kommander Girdle Head Hardware Kit	KOM-110-HARDWARE

Description	Bore Size	Dome Size	Part No.
K1100 Dome	82mm	24cc	KOM-822400-ZXI
K1100 Dome	82mm	26cc	KOM-822600-ZXI
K1100 Dome	82mm	28cc	KOM-822800-ZXI
K1100 Dome	82mm	30cc	KOM-823000-ZXI
K1100 Dome	82mm	32cc	KOM-823200-ZXI
K1200 Dome	85mm	24cc	KOM-852400-ZXI
K1200 Dome	85mm	26cc	KOM-852600-ZXI
K1200 Dome	85mm	28cc	KOM-852800-ZXI
K1200 Dome	85mm	30cc	KOM-853000-ZXI

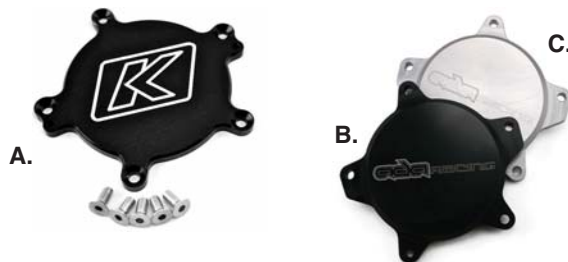

KAWASAKI 1100 ENGINE OIL INJECTION PUMP BLOCK OFF PLATE

Billet aluminum oil injection block off plate for Kawasaki 1100. Stainless allen bolts and O-ring included.

Description	Part No.
A. Kommander Industries Oil Injection Pump Block Off Plate - Black	KOM-1100-FBO
B. ADA Front Oil Injection Cover - Black	31-453000
C. ADA Front Oil Injection Cover - Silver	31-453090



TBM RACING 1100 TOTAL LOSS FLYWHEEL

Weighing in at 2.2 pounds (stock is 4.0 pounds) you will gain a tremendous increase in acceleration and midrange powder simply by bolting this masterpiece on.

Description	Part No.
TBM Racing 1100 Total Loss Flywheel	TBM124-1100

KAWASAKI 1100/1200 SXR CONVERSION



DASA KAW 1100/1200 BILLET INTAKE MANIFOLD

Dasa's billet intake manifold for Mikuni 44mm to 50mm carbs, featuring a carb speed plate and developed for V-Force 3 reed applications (V3150-794-3). Supplied with all required hardware, gaskets and both a pump and diaphragm throttle cable brackets.

Description	Part No.
DASA Kaw 1100/1200 Billet Intake Manifold	KA-1101
Replacement O-ring (Sold individually)	137V



DASA CARBURETOR

Description	Part No.
DASA 48mm Triple Carburetor	BN-4803

See page 112 for more information about DASA Carburetors



NOVI-TEC CARBURETOR KIT

Description	Part No.
Novi-Tec 48mm Triple Carburetor Kit	TK48XRF-S/S

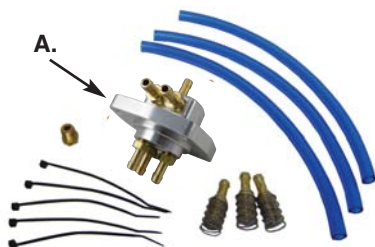

FUEL PICKUP FOR 1100 SXR CONVERSION & ZXI/STX-R

Provides maximum fuel flow to triple carbs applications.

Used by the top Professional Racers for conversion Race Ski applications. This is a complete kit that includes all required parts.

Description	Color	Part No.
1100 SXR/ZXI/STX-R Fuel Pickup Kit	Silver	53-9957
1100 SXR/ZXI/STX-R Fuel Pickup Kit	Black	53-9958
A. Billet Fuel Pick Up Top Only	Silver	31-452090
Billet Fuel Pick Up Top Only	Black	31-452000



KOMMANDER KAWASAKI 1100/1200 INTAKE MANIFOLD



The new Kommander Kawasaki 1100 Triple intake manifold now features a speed plate for easier removal of the carbs. Designed to fit all 44mm thru 49mm Mikuni carbs. Supplied with all required hardware and gaskets.

Description	Part No.
Kommander Kaw 1100/1200 Intake Manifold	KOM-107-SP
Replacement O-ring (Sold individually)	KOM-HWN70-226



CARBURETORS SUPPORT RAIL

Description	Part No.
Kommander Triple Carburetor Support Rail	KOM-250-CBAR



KOMMANDER 1100/1200 SXR EXHAUST CONVERSION KIT (EXHAUST SIDE)

Comes with all required hoses and clamps for installation.

Description	Part No.
Kommander Kaw 1100/1200 Exhaust Conversion Kit (Exhaust Side)	KOM-130-ZXI



KOMMANDER 1100/1200 SXR EXHAUST ROUTING KIT (INTAKE SIDE)

Comes with all required hoses and clamps for installation.

Description	Part No.
Kommander Kaw 1100/1200 Exhaust Routing Kit (Intake Side)	KOM-135-ZXI



KOMMANDER 1100/1200 SXR TRIPLE HIGH FLOW EXHAUST GASKET

Description	Part No.
Kommander Kaw 1100/1200 Triple High Flow Exhaust Gasket (Sold Individually)	KOM-13-ZXI

ENGINE CONVERSION
INTAKE SYSTEMS
ENGINE/GASKETS
EXHAUST
DRIVE LINE HANDLING
ELECTRICAL
WATERLINE /BILGE
STEERING & CONTROLS
BODY
ACCESSORIES
SERVICE TOOLS /HARDWARE
CHEMICAL

KAWASAKI 1100/1200 CONVERSION



ADA RACING 1100 SXR DRIVE COUPLER CONVERSION

Billet aluminum drive coupler for the Kawasaki 900/1100 that uses the 750/800 damper. This coupler is for putting a 900/1100 engine into a 750/800 hull.

The threads are 24-1.5mm and fit the Kawasaki 1100 crankshaft. This coupler makes light work of coupling the 1100 motor to the SXR drive shaft. Kawasaki style coupler for crank side only of the 1100 motor.

Description ADA Racing 1100 SXR Drive Coupler Conversion
Part No. 31-700390



RHAAS SXR 1100 CONVERSION BEARING

Bearing and seals are moved forward 1/2". Made from anodized aluminum. Comes pre-assembled with bearing and seals.

Description SXR1100 Conversion Bearing
Part No. SXRBEARING

ENGINE CONVERSION



ADA BILLET ENGINE MOUNT YAMAHA 3 CYL CONVERSION TO WAVE BLASTER

Billet engine mount brackets to allow the Yamaha 1100/1200 (non-power valve) engine to drop right into a WaveBlaster. Sets the rear of the engine in the same spot as the stock, so you still use the stock mid-shaft. Only modification required is to remove the waterbox and grind part of the rib from the waterbox tray.

Description Billet Engine Mount
Part No. 34-550190



WATCON ENGINE CONVERSION PLATE KAWASAKI 440/550 TO 650/750/800 ENGINES

This engine conversion plate allows you to easily install a Kawasaki 650/750/800 engine to Kawasaki 440/550 Hull.

Description Engine Conversion Plate
Part No. 550-CONV

ENGINE CONVERSION

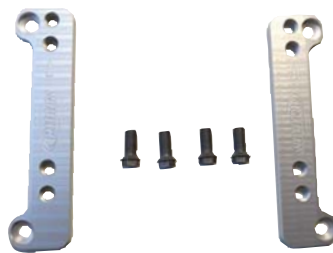

RHAAS CONVERSION KITS FOR KAWASAKI 440/550

Put a Kawasaki 650/750/800 in your Kawasaki 440/550 hull. Allows two engine mounting positions to allow use of a re-tapped 550 coupler. Comes with all hardware.

Description Engine Conversion Kit
Part No. 550-650-CONV

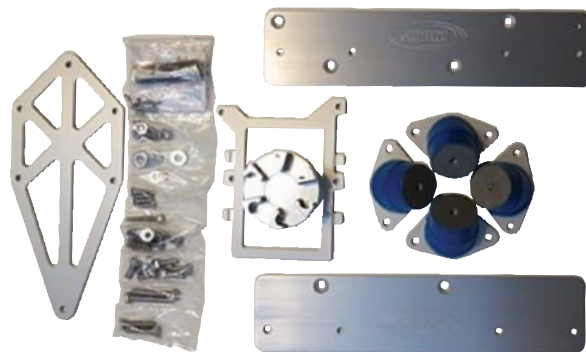

RHAAS CONVERSION KITS FOR KAWASAKI 440/550

Put a Yamaha 650/701/760 in your Kawasaki 440/550 hull. Comes with everything needed to make the swap.

Description Engine Conversion Kit
Part No. 550-701-CONV



RHAAS CONVERSION KITS FOR KAWASAKI 650/750/800

Put a Yamaha 650/701/760 in your Kawasaki hull. Comes with motor plates, motor mounts and all hardware.

Description Engine Conversion Kit
Part No. 650-701-CONV



RHAAS 550 CONVERSION BEARING

Converts early hulls to run the 550SX driveline. Made from anodized aluminum. Comes pre-assembled with bearing and seals.

Description 550 Conversion Bearing
Part No. 550BEARING

HYDROSPACE S4



PROX PISTONS

Forged Pistons. Kit includes:
Piston, Rings, Clips and Pins.
Standard Compression: 9.0:1

Description	Size	Part No.
Hydrospace S4 (2005-09)	84.94	01.7705.A
Hydrospace S4 (2005-09)	84.95	01.7705.B
Hydrospace S4 (2005-09)	84.96	01.7705.C



WAVE S.R.L. BILLET INTAKE ADAPTER

New turbo air intake adapter for S4, this adds 1.4 mph at top speed on the 140hp Kit, and a better throttle response. Recommended for use with Hot Products Tornado 2 1/2" Filters.

Description	Part No.
Wave S.R.L. Billet Intake Adapter	S4-BLTINTADA
2 1/2" Hot Products Tornado Filter*	53-4274-SIL

*Black, Blue, Red and Green filters also available, see page 127



RHAAS MOTOR MOUNT

These mounts are made from 6061 aluminum and anodized for corrosion protection and a long life. The urethane is locked into

the base and the threaded insert to provide a one piece, mechanical lock on all components. These mounts do not rely on glue to hold things together, the mount is molded at one time with the billet threaded insert and the billet aluminum base. Motor mounts sold individually.

Description	Part No.
Hydrospace S4 Motor Mount	HYDROMOUNT

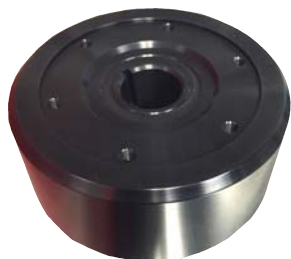

TBM BILLET CHARGING FLYWHEEL FOR HYDROSPACE

Description	Part No.
Hydrospace S4 Charging Flywheel	TBM124-HS

* Hydrospace flywheel uses the same puller as Kawasaki charging flywheel (TBM152). Please see page 224.

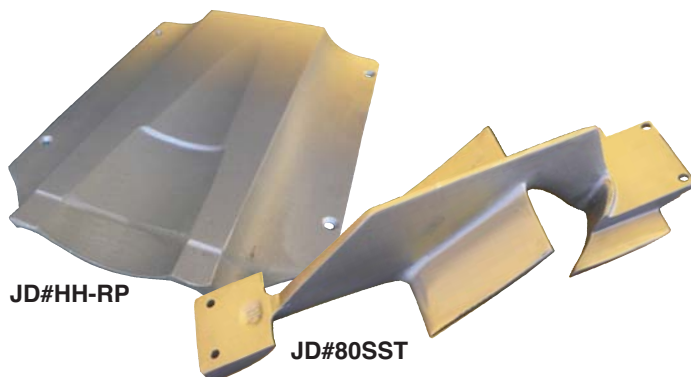

JET DYNAMICS INTAKE GRATE AND RIDE PLATE

Description	Part No.
Hydrospace S4 Intake Grate (Deep)	JD#80SST
Hydrospace S4 Ride Plate	JD#HH-RP



PRO WATERCRAFT RIDE PLATE

*HFC is Hybrid Flex Composite

Description	Part No.
Hydrospace HFC Ride Plate	PW-02-300-T2-HFC



WAVE S.R.L. FRONT SPONSONS

New full material molding compressed polyurethane. These front sponsons allow for faster turns, no submarining in turns, better and easier control in race conditions. Used by some of the top Pro Racers on Kawasaki SX-Rs and Hydrospace S4s: Alberto Monti (2008 Pro Ski Open World Champion), Steve Dauliach (2011/2012 IJSBA Pro Ski World Champion), Renaud Urbain, Alessia Ida, Macc, Goodchild, Bossche and many other Pro Racers. These sponsons will change and improve the handling of the SX-R and Hydrospace dramatically! Made in Italy.

Short version of Front Sponson is legal for Ski Stock, Ski Limited, Ski Superstock and Ski GP.

Long version of Front Sponson is legal for Ski Limited, Ski Superstock and Ski GP (No Ski Stock for 2013 IJSBA rules).

Description	Part No.
Wave S.R.L. Front Sponsons Black Short Version - 90cm Length	FFS101
Wave S.R.L. Front Sponsons Black Long Version - 126.5cm Length	FFS-L



TBM RACING RACE BUMPERS

Description	Part No.
TBM Racing Hydrospace Race Bumpers	TBM117-HSR

HYDROSPACE SYSTEMS	INTAKE	ENGINE/GASKETS	EXHAUST	DRIVE LINE HANDLING	ELECTRICAL	WATERLINE /BILGE	STEERING & CONTROLS	BODY	ACCESSORIES SERVICE TOOLS /HARDWARE	CHEMICAL
--------------------	--------	----------------	---------	---------------------	------------	------------------	---------------------	------	-------------------------------------	----------

HYDROSPACE S4



Actual product may be different from this image.

SOLAS COMPLETE PUMP ASSEMBLY FOR HYDROSPACE S4

Description	Part No.
Pump Assembly for Hydrospace S4	HS-PM-140/74T



SKAT-TRAK HYDROSPACE 140-75 SWIRL

Pitch	Part No.	Pitch	Part No.
9/17	SHY4075SW917	13/18	SHY4075SW1318
9/17R	SHY4075SW917R	13/18R	SHY4075SW1318R
10/18	SHY4075SW1018	14/19	SHY4075SW1419
10/18R	SHY4075SW1018R	14/19R	SHY4075SW1419R
12/17	SHY4075SW1217	14/22	SHY4075SW1422
12/17R	SHY4075SW1217R	14/22R	SHY4075SW1422R



HYDROSPACE BILLET DRIVE COUPLER SET

Billet drive coupler set for the Hydro-space watercraft. These couplers use

the Kawasaki 4-stroke rubber damper (Part #003-209). They will not work with the stock Hydro rubber damper! Thread pitch is 24-2.0mm The diameter is 4.34 inches and the overall length of each coupler is 2.775 inches. Approximate assembly length with rubber damper is 4.48 inches.

Description	Part No.
ADA Drive Coupler Set	35-700190
Rubber Damper	003-209



DRIVE COUPLER REMOVAL TOOL

For all Hydrospace S4, Polaris MSX and Weber Power Billet Drive Couplers.

Description	Part No.
Hydrospace Drive Coupler Removal Tool	DC-1200



HYDROSPACE REPLACEMENT DRIVE SHAFT

Description	Part No.
Wave s.r.l. Hydrospace Driveshaft	HSR000521001



PRO WATERCRAFT CHIN PADS

Description	Part No.
Chin Pad for the Hydrospace OEM Handle Pole	PW-02-100



HYDRO-TURF & JETTRIM MAT KITS

Description	Part No.
Hydrospace S4 with 2" Kick Tail Mat Kit - Black	HT100-BLK
Jettrim Hydrospace Bottom Mat	HS101
Jettrim S4 8 Piece Mat Set	HS102



PRO WATERCRAFT HYDROSPACE KICKER TRAY EXTENSION

Description	Part No.
Hydrospace S4 Kicker Tray Extension - Black	PW-02-610



VERSIPLUG "THE ORIGINAL" DRAIN SYSTEM

Versiplug is a self-bailing drain plug system produced using aircraft grade aluminum, water resistant plastic and stainless steel. Installation is simple, quick and easy. The kit will completely drain your PWC without you having to do anything.

Description	Color	Part No.
Versiplug Original - Hydrospace	Black	PD1151

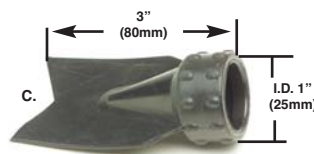

HYDROSPACE DUCK BILL

The replacement for the OEM Duck Bill Flapper.

Description	Part No.
Hydrospace Replacement Duck Bill	57-4055

HYDROSPACE
INTAKE SYSTEMS
ENGINE/GASKETS
EXHAUST
DRIVE LINE HANDLING
ELECTRICAL
WATERLINE/BILGE
STEERING & CONTROLS
BODY
SERVICE TOOLS ACCESSORIES
CHEMICAL/HARDWARE

CARBURETOR REBUILD & FILTER ADAPTOR APPLICATIONS

Manufacturer	Stock Carb Type	Carb Qty.	OEM Carb Rebuild Kit Part #	Adapter Part #
SEA-DOO				
580GTX 92-94	38M SBN	2	MK-BN38/44 SPR	53-4460
580GT 90-96	38M SBN	1	MK-BN38/44 SPR	53-4460
580GTS 93-96	38M SBN	2	MK-BN38/44 SPR	53-4460
580SP 88-96	38M SBN	1	MK-BN38/44 SPR	53-4460
580SPX 92-94	38M SBN	2	MK-BN38/44 SPR	53-4460
580 SPI 88-96	38M SBN	1	MK-BN38/44 SPR	53-4460
650XP 94	40M"1"	2	MK-BN38/44 SPR	53-4465
650XP 93	40M"1"	2	MK-BN38/44 SPR	53-4465
650GTX 95	40M"1"	2	MK-BN38/44 SPR	53-4465
650SPX 95	40M"1"	2	MK-BN38/44 SPR	53-4465
720XP 95	40M"1"	2	MK-BN38/44 SPR	53-4465
720GTI 97-99	40M"1"	1	MK-BN38/44 SPR	53-4465
720GTI 96	40M"1"	2	MK-BN38/44 SPR	53-4465
720GTS 97-00	40M"1"	1	MK-BN38/44 SPR	53-4465
720SP 97	40M"1"	1	MK-BN38/44 SPR	53-4465
720SPX 96	40M"1"	2	MK-BN38/44 SPR	53-4465
720HX95-97	40M"1"	2	MK-BN38/44 SPR	53-4465
720GS 97-00	40M"1"	1	MK-BN38/44 SPR	53-4465
720GSI 97	40M"1"	1	MK-BN38/44 SPR	53-4465
800GTX 96-97	40M"1"	2	MK-BN38/44 SPR	53-4465
800GSX 96-97	40M"1"	2	MK-BN38/44 SPR	53-4465
800XP 95-97	40M"1"	2	MK-BN38/44 SPR	53-4465
800SPX 97-99	40M"1"	2	MK-BN38/44 SPR	53-4465
950GSX LTD 97-99	46M"1"	2	MK-BN46I	Not Required
950XP LTD 98-00	46M"1"	2	MK-BN46I	Not Required
950GTX LTD 98-99	46M"1"	2	MK-BN46I	Not Required

YAMAHA				
W/Jammer 500 88-89	38M BN	1	MK-BN38/44	53-4460
W/Runner 500 88-89	38M BN	1	MK-BN38/44	53-4460
W/runner 650 90-95	44M BN	1	MK-BN38/44	53-4480
W/Runner III 650 90-95	44M SBN	1	MK-BN38/44 SPR	53-4480
VXR 650 91-95	44M SBN	1	MK-BN38/44 SPR	53-4480
SuperJet 650 90-93	44M SBN	1	MK-BN38/44 SPR	53-4480
W/Raider 701 94-95	38M SBN	2	MK-BN38/44 SPR	53-4460
W/Raider 701 96-97	44M SBN	1	MK-BN38/44 SPR	53-4480
W/Venture 701 95-98	38M SBN	2	MK-BN38/44 SPR	53-4460
W/Blaster 701 96-97	38M SBN	2	MK-BN38/44 SPR	53-4460
W/Blaster 701 93-95	44M SBN	1	MK-BN38/44 SPR	53-4480
SuperJet 701 94-95	44M SBN	1	MK-BN38/44 SPR	53-4480
SuperJet 701 96-13	38M SBN	2	MK-BN38/44 SPR	34-120290
FX1 701 94-95	44M SBN	1	MK-BN38/44 SPR	53-4480
XL700 95-00	38M SBN	2	MK-BN38/44 SPR	53-4460
GP760 97-00	44M SBN	2	MK-BN38/44 SPR	53-4480
XL760 98-99	44M SBN	2	MK-BN38/44 SPR	53-4480
W/Raider 760 96	44M SBN	2	MK-BN38/44 SPR	53-4480
W/Blaster II 760 96-97	44M SBN	2	MK-BN38/44 SPR	53-4480
W/Venture 760 96-98	44M SBN	2	MK-BN38/44 SPR	53-4480
GP800 98-00	44M"1"	2	MK-BN44I-YAM	34-120190
W/Raider 1100 95-06	38M SBN	3	MK-BN38/44 SPR	53-4460
W/Venture 1100 96-98	38M SBN	3	MK-BN38/44 SPR	53-4460
XL1200 98	44M"1"	3	MK-BN44I-YAM	34-120190
GP1200 97-99	44M SBN	3	MK-BN38/44 SPR	53-4480
GP1200R 00-02	44M"1"	3	MK-BN44I-YAM	34-120190
SUV 99-03	44M SBN	3	MK-BN38/44 SPR	53-4480
GR800R 00-05	44M"1"	2	MK-BN44I-YAM	34-120190
XL800 01	44M"1"	2	MK-BN44I-YAM	34-120190
XLT800 02-04	44M"1"	2	MK-BN44I-YAM	34-120190
XLT1200 01-05	44M"1"	3	MK-BN44I-YAM	34-120190
GP1300R	44M"1"	3	MK-BN44I-YAM	34-120190

TIGER SHARK				
Daytona Tigershark 93	44M SBN	1	MK-BN38/44 SPR	53-4480
Tigershark 93	44M SBN	1	MK-BN38/44 SPR	53-4480
Barracuda 94-95	46M SBN	1	MK-BN38/44 SPR	53-4490
Daytona 94	46M SBN	1	MK-BN38/44 SPR	53-4490
Monte Carlo 94-95	46M SBN	1	MK-BN38/44 SPR	53-4490
Montego 640 94-95	44M SBN	1	MK-BN38/44 SPR	53-4480
Montego Deluxe 94-96	44M SBN	1	MK-BN38/44 SPR	53-4480
Daytona 95	38M SBN	2	MK-BN38/44 SPR	53-4460
Montego 95	46M SBN	1	MK-BN38/44 SPR	53-4490
Tigershark 95	44M SBN	3	MK-BN38/44 SPR	53-4480
Daytona 770 96-97	38M SBN	2	MK-BN38/44 SPR	53-4460
Monte Carlo 770 Blue 96	38M SBN	2	MK-BN38/44 SPR	53-4460
Monte Carlo 770 Red 96	38M SBN	2	MK-BN38/44 SPR	53-4460
Monte Carlo 900 96	38M SBN	3	MK-BN38/44 SPR	53-4460
Daytona 1100 97	40M"1"	3	MK-BN38/44 SPR	53-4465
Monte Carlo 640 97	38M SBN	1	MK-BN38/44 SPR	53-4460
Monte Carlo 770 97	40M"1"	2	MK-BN38/44 SPR	53-4465
Monte Carlo 1100 97	40M"1"	3	MK-BN38/44 SPR	53-4465
Montego 97	38M SBN	1	MK-BN38/44 SPR	53-4460
Montego Deluxe 97	38M SBN	1	MK-BN38/44 SPR	53-4460
TS 640 98	40M"1"	1	MK-BN38/44 SPR	53-4465
TS 770 98	40M"1"	1	MK-BN38/44 SPR	53-4465

Manufacturer	Stock Carb Type	Carb Qty.	OEM Carb Rebuild Kit Part #	Adapter Part #
TIGER SHARK				
TS-L 640 98-99	38M SBN	1	MK-BN38/44 SPR	53-4460
TS-L 770 98-99	38M SBN	2	MK-BN38/44 SPR	53-4460
TS-L 1100 98	40M"1"	3	MK-BN38/44 SPR	53-4465
TS-R 770 98-99	38M SBN	2	MK-BN38/44 SPR	53-4460
TS-R 1100 98	40M"1"	3	MK-BN38/44 SPR	53-4465
TS 770L 99	40M"1"	1	MK-BN38/44 SPR	53-4465
TS 900L 99	40M"1"	3	MK-BN38/44 SPR	53-4465
TS 1100R 99	42M"1"	3	MK-BN38/44 SPR	

KAWASAKI				
JS300 86-91	38M BN	1	MK-BN38/44	53-4460
JS400 74-76	38M BN	1	MK-BN38/44	53-4460
JS440 77-90	38M BN	1	MK-BN38/44	53-4460
JS440 91-92	42K	1	53-2103	53-4440
JS550 82-85	38M BN	1	MK-BN38/44	53-4460
JS550 86-90	44M BN	1	MK-BN38/44	53-4480
JS550SX 91-95	38K	1	53-2103	53-4440
650X2 86-90*	28K	1	53-2100	Not Available
<i>*This model utilizes an External Fuel Pump - Fuel Pump Rebuild Kit Part# 53-2105</i>				
650X2 91-94	38K	1	53-2103	53-4440
JS650SX 87-90*	28K	1	53-2100	Not Available
<i>*This model utilizes an External Fuel Pump - Fuel Pump Rebuild Kit Part# 53-2105</i>				
JS650SX 91-94	38K	1	53-2103	53-4440
650TS 89-96	38K	1	53-2103	53-4440
650SC 90-95	38K	1	53-2103	53-4440
750SX 92-95	40K	1	53-2103	53-4440
750SX1 95	40K	2	53-2103	53-4440
750SX1 96-97	40M"1"	2	MK-BN38/44 SPR	53-4465
750SX1 PRO 98-00	40M"1"	2	MK-BN38/44 SPR	53-4465
750SS 92-98	40K	1	53-2103	53-4440
750X1 93-97	40K	2	53-2103	53-4440
750XIR 94	40K	2	53-2103	53-4440
750ST 93-95	40K	1	53-2103	53-4440
750STS 95-97	40K	2	53-2103	53-4450
750ZXI 95-98	40K	2	53-2103	53-4450
800SX-R 03-12	40M"1"	2	MK-BN38/44 SPR	53-4465
900ZXI 95-97	38K	3	53-2103	53-4450
900STX 97-99	38K	3	53-2103	53-4450
1100ZXI 96-97	38K	3	53-2103	53-4450
1100STX 97-99	38K CDCV	3	Not Available	Not Available
ULTRA150 99-00	40K CDCV	3	Not Available	Not Available

POLARIS				
SL650 92-95	38M SBN	3	MK-BN38/44 SPR	53-4460
SL650 STD 95	38M SBN	3	MK-BN38/44 SPR	53-4460
SL700 96	KEIHIN	2	53-2103	53-4450
SL700 97	42K	1	53-2103	53-4440
SL700 DELUXE 97	KEIHIN	2	53-2103	53-4450
SLT700 96-97	KEIHIN	2	53-2103	53-4450
SL750 93-95	38M SBN	3	MK-BN38/44 SPR	53-4460
SLT750 95	38M SBN	3	MK-BN38/44 SPR	53-4460
SLT 94	38M SBN	3	MK-BN38/44 SPR	53-4460
SL780 96-97	38M SBN	3	MK-BN38/44 SPR	53-4460
SL900 96-97	KEIHIN	2	53-2103	53-4450
SL1050 97	KEIHIN	2	53-2103	53-4450
SLH 98-99	KEIHIN	2	53-2103	53-4450
SLH-2 Pass 00	KEIHIN	2	53-2103	53-4450
SLH-2 Pass 01	KEIHIN		53-2103	53-4450
SLT780 96-97	38M SBN	3	MK-BN38/44 SPR	53-4460
SLTH 98-99	KEIHIN	2	53-2103	53-4450
SLX 99	KEIHIN	2	53-2103	53-4450
SLX 2-Pass 00-01	KEIHIN	2	53-2103	53-4450
SLTX 96-99	KEIHIN	2	53-2103	53-4450
SLTX-B 99	MIKUNI "I"	3	MK-BN38/44 SPR	53-4465
SLX780 95-96	38M SBN	3	MK-BN38/44 SPR	53-4460
SLX Pro785 97-98	MIKUNI SBN	3	MK-BN38/44 SPR	
SLXH 98	KEIHIN	2	53-2103	53-4450
SLXH Euro 98	KEIHIN	2	53-2103	53-4450
Hurricane 96-97	KEIHIN	2	53-2103	53-4450
Pro 785 99	MIKUNI SBN	3	MK-BN38/44 SPR	
Pro 785 2-Pass 00	MIKUNI SBN	3	MK-BN38/44 SPR	
Pro1200 2-Pass 00-01	KEIHIN	2	53-2103	53-4450
Genesis 99	KEIHIN		53-2103	53-4450
Genesis 4-Pass 00-02	KEIHIN	2	53-2103	53-4450
Virage 3-Pass 00-03	KEIHIN		53-2103	53-4450
Virage TX 3-Pass 00,02	KEIHIN	2	53-2103	53-4450
Freedom 3-Pass 02-03	KEIHIN		53-2103	53-4450
Freedom DA 04	KEIHIN		53-2103	53-4450
Freedom IA 04	KEIHIN		53-2103	53-4450
Octane 02-03	KEIHIN	2	53-2103	53-4450

AFTERMARKET RACING CARBS:
 NOVI-TEC, DASA Racing, RIVA Powerbomb, Blackjack, Full Spectrum.
 All use rebuild kit: **MK-BN38/44 SPR**

FOUR STROKE
 INTAKE SYSTEMS
 ENGINE/GASKETS
 EXHAUST
 DRIVE LINE HANDLING
 ELECTRICAL
 WATERLINE /BILGE
 STEERING & CONTROLS
 BODY
 ACCESSORIES SERVICE TOOLS /HARDWARE
 CHEMICAL



MIKUNI CARBURETORS

HI-PERFORMANCE SUPER BN

Extended Throttle Shaft Without Choke Shaft



38MM
Part # BN38-34-8113



44MM
Part # BN44-40-8067



44MM
Part # BN44-40-8052



46MM
Part # BN46-42-8002

Carburetor gasket information available on page 99 in the Mikuni carburetor chart



OEM REPLACEMENT SUPER BN

Regular Throttle Shaft With Choke Shaft

*** Direct replacement of OEM Carburetors at a fraction of OEM cost. ***

MAG-SIDE



40MM – I-SERIES

MAG-SIDE (FRONT)

Part # BN40I-38-26

PTO-SIDE (REAR)

Part # BN40I-38-27

Sea-Doo 720 GTI, GTS, GS, GSI '98, 800 GTX, GSX '96-'00, 800 SPX 97-99, 800 XP '95-'99, 951 GSX LTD '97

PTO-SIDE



38MM

Part # BN34-28-8010

Yamaha

Wave Runner 500 88-89

Wave Jammer 500 88-89



40MM – I-SERIES

Part # BN40I-38-24

Sea-Doo 720,
GTI, GTS, GS, GSI, '97



44MM

Part # BN44-40-43

Single Carb Yamaha

SJ 650 (90-93), SJ 701 (94-95),

Wave Blaster 701 (93-95),

Tigershark Monte Carlo 650 (96)

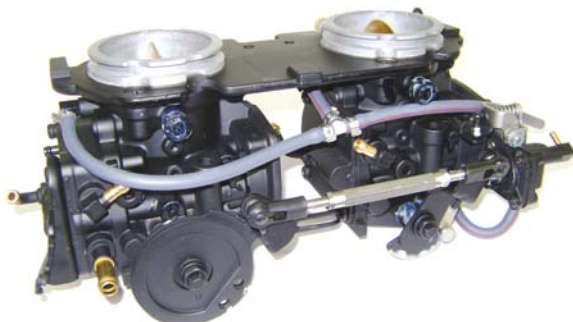

DUAL CARBURETOR SET

46MM – I-SERIES

Part # BN46I-42-B4

Sea-Doo 951,
GSX, GTX, XP-LTD, '98-01, XP'00, RX, LRV

Note: Sold as a fully assembled dual carburetor set.

Carburetor gasket information available on page 99 in the Mikuni carburetor chart



GENUINE CARBURETOR REBUILD KITS

Kits include all necessary gaskets, diaphragms, and hardware required to disassemble and rebuild Mikuni carburetor.

See page 97 for Applications of Rebuild Kits

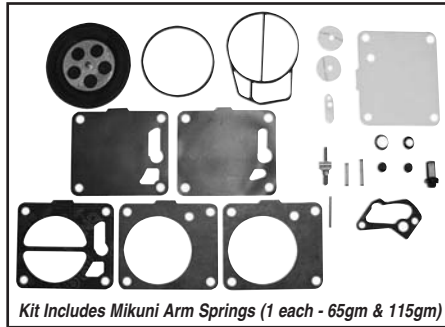

Kit Includes Mikuni Arm Springs (1 each - 65gm & 115gm)

Mikuni **Diaphragm Cover** **Part No.**
Super BN Square **MK-BN38/44-SPR**
38mm, 44mm, 46mm and I Series 38/40

*Sea-Doo Pre 97, Kawasaki 750 98-02, 800 SX-R 03-08 and ALL Mikuni Performance Super BN Square Body 38mm, 44mm and 46mm carbs

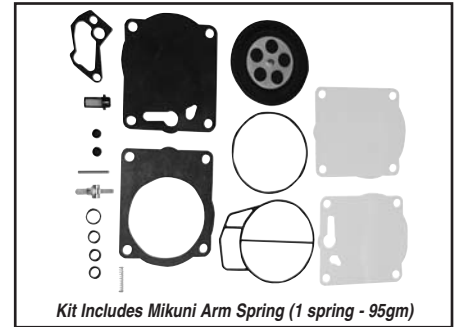

Kit Includes Mikuni Arm Spring (1 spring - 95gm)

Mikuni **Diaphragm Cover** **Part No.**
I Series 46mm Square **MK-BN461**
 *Sea-Doo 951 (98 and newer)

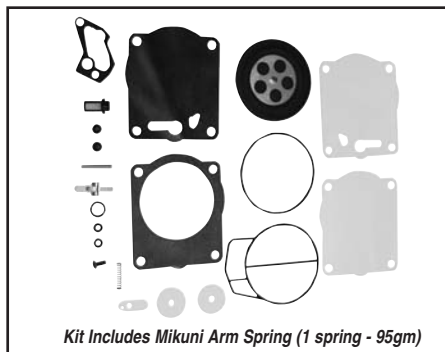

Kit Includes Mikuni Arm Spring (1 spring - 95gm)

Mikuni **Diaphragm Cover** **Part No.**
I Series 44mm/46mm Square **MK-BN441-YAM**

*Yamaha GP800 98-99, GP 800R 00-05, XL 800 01, XLT 800 02-04, GP 1200R 00-02, XL1200 Limited 99-00 and XLT 1200 01-05 **Yamaha Engine Type 60T, 66E, 66V, 67X, 68N**

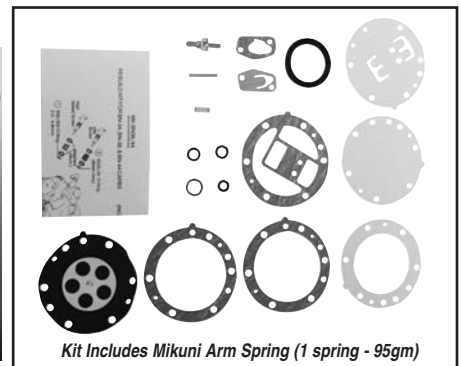

Kit Includes Mikuni Arm Spring (1 spring - 95gm)

Mikuni **Diaphragm Cover** **Part No.**
BN 38mm, 44mm Round **MK-BN38/44**

*BN carbs are "Old Style/Round Body" with round diaphragm covers

MIKUNI SUPER BN SPECIFICATIONS

Carb Type	Mikuni Part No.	Low Speed Jet	High Speed Jet	Needle Valve	Arm Spring (Grams)	Choke Carb Primer	Carb Color	Standard Carb Base Gasket	Green Carb Base Gasket
SBN38	BN38-34-8113	65	107.5	2.0	115 grams	Primer	Silver	5030	9230
SBN44	BN44-40-8052	100	125	2.3	65 grams	Primer	Black	5460	9240
SBN44	BN44-40-8067	120	140	2.5	80 grams	Primer	Silver	5460	9240
SBN46	BN46-42-8002	120	150	2.5	80 grams	Primer	Silver	9245	9250
OEM Yamaha SBN44	BN44-40-43	120	115	1.5	115 grams	Choke	Black	5460	9240
OEM Yamaha SBN38	BN34-28-8010	77.5	80	1.5	65 grams	Choke	Black	5030	9230
I Series 44	BN40I-38-24	70	167.5	1.5	95 grams	Choke	Black	6107	-
I Series 40 (Mag-Side Front)	BN40I-38-26	67.5	140	1.5	95 grams	Choke	Black	6107	-
I Series 40 (PTO-Side Rear)	BN40I-38-27	67.5	142.5	1.5	95 grams	Choke	Black	6107	-
Sea-Doo Dual I Series 46	BN46I-42-B4	77.5	162.5	2.0	95 grams	Choke	Black	-	6740

FOUR STROKE
 INTAKE SYSTEMS
 ENGINE/GASKETS
 EXHAUST
 DRIVE LINE HANDLING
 ELECTRICAL
 WATERLINE /BILGE
 STEERING & CONTROLS
 BODY
 ACCESSORIES SERVICE TOOLS
 /HARDWARE
 CHEMICAL



SUPER BN38 / BN44 / BN46

Socket Bolt Kit

59-9131

See bottom of page

- * Super BN38 and Late Super BN44
- ** Early Super BN44

MIKUNI GENUINE PARTS

Diagram No.	Description	Mikuni Part No.
1.	Gasket Pump (2)	BN38/547
1a.	O-Ring*	.616-72001
2.	Diaphragm, Pump (Clear)	BN34/97
3.	Check Valve (2) (Clear)	BN34/124
4.	Grommet, Check Valve (2)	BN34/125
5.	Diaphragm, Damper (large hole)**	BN34/100
5a.	Diaphragm, Damper (small hole)*	BN34/129
6.	Gasket, Damper**	BN34/101
6a.	O-Ring*	.616-92007
7.	Filter	BN44/146
8.	O-Ring, Hi Speed	B30/305
9.	O-Ring, Low Speed	MD12/16
10.	O-Ring, Needle Valve	KV/10
11.	Gasket Valve Body	BN34/123
12.	Check Valve (Clear)	BN34/107
13.	Spring, Arm (115 grams)	<i>see pg 102</i>
13a.	Spring, Arm (65 grams)	<i>see pg 102</i>
13b.	Spring, Arm (95 grams)	<i>see pg 102</i>
14.	Pin, Arm	VM30/97
15.	Arm (Stainless)	BN38/534
16.	Diaphragm Assembly	BN44/145

MK-BN38/44 SPR REBUILD KIT

18.	Cover Pump	
19a.	Body Assembly Pump (Must use w/O-Ring 1A)	BN34/128
20.	Stop Screw, Idle**	BN44/109
20a.	Stop Screw, Idle*	BN34/82
21.	Washer (Aluminum - Same as #26)	BN38/39
22.	Spring, Idle**	BN38/341
22a.	Spring, Idle (Same as #25)*	BN38/344
24.	Adjuster, Hi Speed (with Cross Bar)	BN44/167
25.	Spring, Hi Speed (Same as #22a)	BN38/344
26.	Washer, Hi Speed (Aluminum - Same as #21)	BN38/39
27.	Washer, Low Speed (Aluminum)	BN38/172
28.	Spring, Low Speed	BN38/343
29a.	Adjuster, Low Speed (with Cross Bar) 38mm	BN38/477
29b.	Adjuster, Low Speed (with Cross Bar) 44mm	BN38/166
33.	Plate, N.V. Retainer	BN34/117-GG
34.	Screw with washer	CW2=0307-G
35.	Low Jet, 30-160 in increments of 5 (See page 102)	N100.606-SIZE
36.	Main Jet, 30-240 in increments of 5 (See page 102)	N102.221-SIZE
37.	Screw	BV15/121-05-GG
38.	Plate, Valve	BN34/108-GG
39.	Valve Body Assembly	BN44/165
40.	Screw (2 pcs)	C5=0414-G
41.	Screw	C6=0308-K
42.	Cover (Stainless)	BN44/147

*Super BN38 and Late Super BN44
**Early Super BN44

Pump Cover
BN34-95B.....No Paint
999-642-002-1A ...Black
999-642-002-1B ...Silver

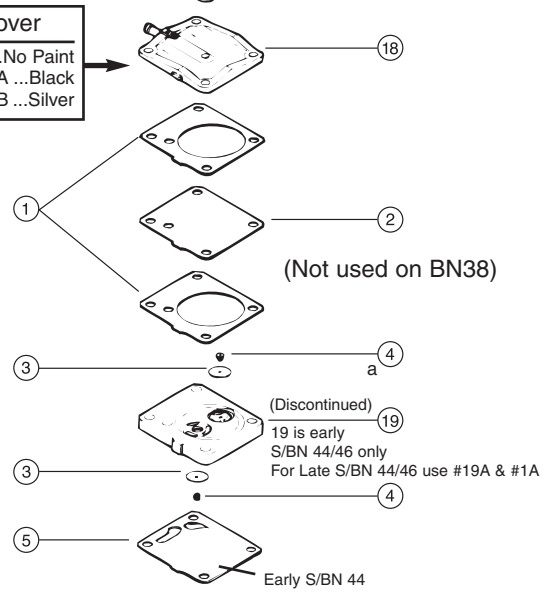

Needle and Seat See Page 102

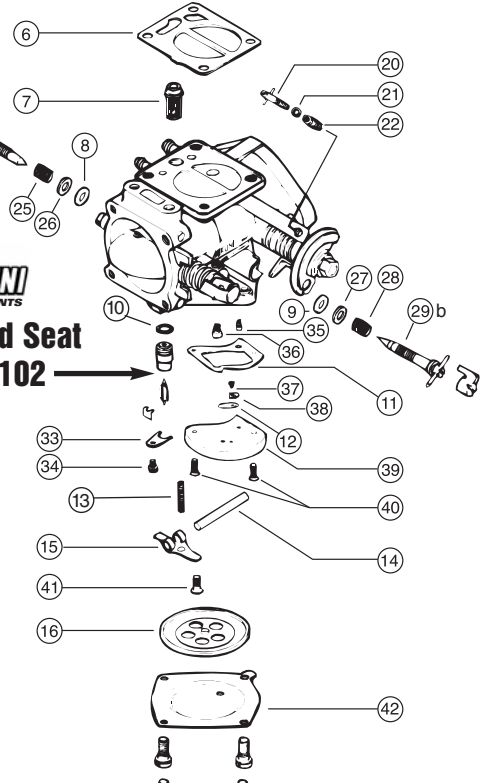

SBN CARBURETOR PUMP BODY AND DIAPHRAGM COVER SOCKET BOLT KIT

Replace the stock phillips bolts on carbs with stainless steel socket head bolts.

Description	Part No.
Mikuni Super BN Bolt Kit (Set of 8)	59-9131
Spring washers not included	



SUPER BN CARBURETOR TUNING MANUAL

For the watercraft tuner working with Super BN series carburetors.

Description	Part No.
Mikuni Tuning Manual	MK-BN/004

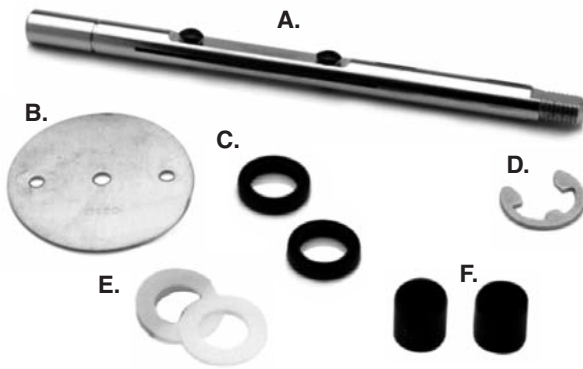

MIKUNI THROTTLE VALVE KIT (A, B, C, D, E & F)

Description	Part No.
Throttle valve (#150) kit for 38mm	MK-BN/038 TV
Throttle valve (#120) kit for 44mm	MK-BN/044 TV
Throttle valve (#120) kit for 46mm	MK-BN/046 TV

THROTTLE SHAFTS AND VALVES (ALL PARTS SOLD INDIVIDUALLY - PER PIECE)

Description	Part No.
A. Super BN 44/46mm Throttle Shaft (Extended)	703-89004
B. Super BN 44mm #120 Throttle Valve	BN44/06-120
B. Super BN 46mm #120 Throttle Valve	818-46009-120
C. Super BN 38mm Throttle Shaft Seal	N127.036
C. Super BN 44/46mm Throttle Shaft Seal	N167.126
D. Super BN 38/44/46mm Throttle Shaft Clip (Heavy Duty)	MK-BN/005
E. Super BN 38/44/46mm Throttle Shaft Washer (Nylon)	N114.077
F. Super BN 38mm Throttle Shaft Bushing (Short)	BN38/514
F. Super BN 38mm Throttle Shaft Bushing (Long)	BN38/539
F. Super BN 44/46mm Throttle Shaft Bushing	BN38/569

All parts sold individually - per piece



Super BN 38

Also used in late style Super BN 44

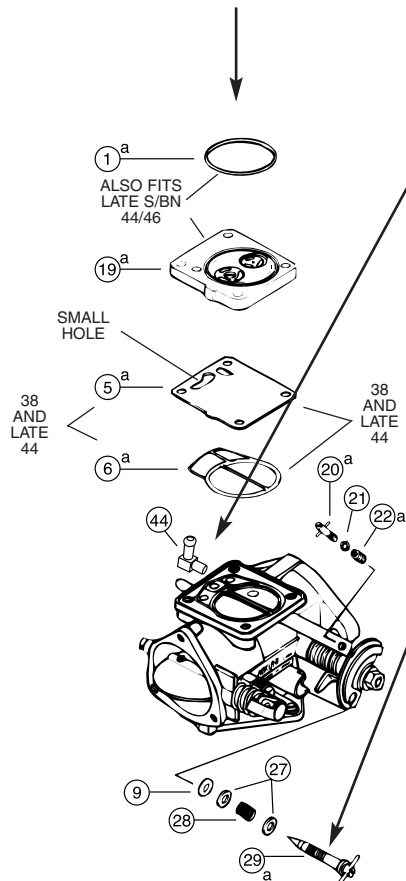

90° FUEL INLET FITTING (PRESS IN)

Description	Diag. #	Part No.
90° Fuel Inlet Fitting	44	DF44-2/70

Sold individually - per piece



ADJUSTER WITH CROSS BAR

Description	Diag. #	Part No.
High Speed 38/44/46	24	BN44/167
Low Speed 38	29a	BN38/477
Low Speed 44/46	29b	BN38/166

(Does not fit Yam OEM 44mm carb)



MK-BN38/44 FUEL INLET COVER

Description	Part No.
MK-BN 38/44 Fuel Inlet Cover	BN38/11



DIAPHRAGM AND FILTER

Description	Diag. #	Part No.
G. Diaphragm Assembly	16.	BN44/145

Super BN 38/44/46

Super BN Diaphragm Dealer 10-Pack BN44/145-10PK

H. Super BN Filter	7.	BN44/146
--------------------	----	----------

Diaphragm Assembly BN38/02 for "Old Style/Round Body"

BN 38/44 series

All parts sold individually - per piece or 10/pkg



SUPER BN I-SERIES ACCELERATOR PUMP DIAPHRAGM

Description	Part No.
Accelerator Pump Diaphragm	BN40I/22
Super BN 38/44/46	

FOUR STROKE	INTAKE SYSTEMS	ENGINE/GASKETS	EXHAUST	DRIVE LINE HANDLING	ELECTRICAL	WATERLINE /BILGE	STEERING & CONTROLS	BODY	ACCESSORIES	SERVICE TOOLS /HARDWARE	CHEMICAL
-------------	----------------	----------------	---------	---------------------	------------	------------------	---------------------	------	-------------	-------------------------	----------



GENUINE MIKUNI CARB COMPARTMENT KIT



PARTS STAMPING This marking on a jetting part is your quality assurance guarantee it is a genuine Mikuni component. **DO NOT ACCEPT SUBSTITUTES.**

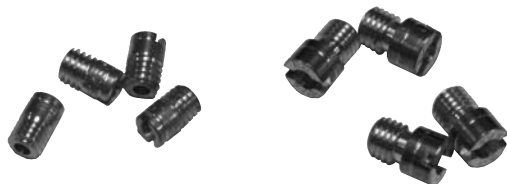

CARBURETOR JETS

Mikuni Low Jets
P/# (N100.606-size)

Size:	30	95
32.5	97.5	
35	100	
37.5	102.5	
40	105	
42.5	107.5	
45	110	
47.5	112.5	
50	115	
52.5	117.5	
55	120	
57.5	122.5	
60	125	
62.5	127.5	
65	130	
67.5	132.5	
70	135	
72.5	137.5	
75	140	
77.5	142.5	
80	145	
82.5	147.5	
85	150	
87.5	155	
90	160	
92.5		

CARBURETOR JETS

Mikuni Main Jets
P/# (N102.221-size)

Size:	30	95	160
32.5	97.5	162.5	
35	100	165	
37.5	102.5	167.5	
40	105	170	
42.5	107.5	172.5	
45	110	175	
47.5	112.5	177.5	
50	115	180	
52.5	117.5	182.5	
55	120	185	
57.5	122.5	187.5	
60	125	190	
62.5	127.5	195	
65	130	200	
67.5	132.5	205	
70	135	210	
72.5	137.5	215	
75	140	220	
77.5	142.5	230	
80	145	240	
82.5	147.5		
85	150		
87.5	152.5		
90	155		
92.5	157.5		

Description

Description	Part No.
Dealer Standard Compartment Kit	53-2120
Performance Compartment Kit	53-2121
Compartment only*	53-2122

*Additional storage/compartment boxes available. See page 107

Dealer Compartment Kit contents:

4 Each of Needle and Seat
1.5/2.0/2.3/2.5
4 Each of Arm Spring
65/80/95/115gm
5 Each of Low Jets
70/72.5/75/77.5/80/82.5/85/87.5/90
92.5/95/97.5/100/102.5/105/110
5 Each of Main Jets
105/110/115/120/125/130/135/140
145/150/155/160

Performance Compartment Kit contents:

4 Each of Needle and Seat
2.0/2.3/2.5
4 Each of Arm Spring
80/95/115gm
5 Each of Low Jets
105/110/115/120/125/130/135/140
145/150/155/160
5 Each of Main Jets
135/140/145/150/155/160/165/170
175/180/185/190

OLD TYPE NEEDLES & SEATS

ROUND DIAPHRAGM COVER STANDARD BN OLD TYPE, STANDARD METAL TIP

— Screw in Type —



Description	Part No.
1.5	VM26/26-1.5
2.0	VM26/26-2.0
2.3	VM26/26-2.3
2.5	VM26/26-2.5
2.8	VM26/26-2.8

NEW TYPE NEEDLES & SEATS

SQUARE DIAPHRAGM COVER SUPER BN (NEW TYPE)

— Push in Type —



Description	Part No.
O-Ring of Seat	KV/10
10/pk O-Rings	KV/10-10

VITON TIP

Recommended for Gas Fuel Applications

Description	Part No.
1.2	—
1.5	786-35015-1.5
1.8	786-35015-1.8
2.0	786-35015-2.0
2.3	786-35015-2.3
2.5	786-35015-2.5

VITON TIP WITH COATING

With Alcohol Protective Coating. Recommended for Alcohol and Ethanol Fuel Applications.

Description	Part No.
1.2	786-35018-1.2
1.5	786-35018-1.5
1.8	786-35018-1.8
2.0	786-35018-2.0
2.3	786-35018-2.3
2.5	786-35018-2.5



MIKUNI ARM SPRINGS

Description	Color	Length		Part No.
		mm	inches	
65 grams	Platinum	14.95	19/32"	730-03030
80 grams	Black	15.1	19/32"	730-03033
95 grams*	Platinum	16.4	41/64"	730-03034
*This 95gm spring is for Sea-Doo BN 46l Carbs Only!				
95 grams	Dull Silver	15.85	5/8"	730-03027-T
115 grams	Shiny Silver	16.85	21/32"	730-03027

POP-OFF PRESSURE CHART

Part. No.	730-03027	730-03027-T	730-03033	730-03030
Arm Springs	115 grams	95 grams	80 grams	65 grams
Needle Valve Size	1.5	55 p.s.i.	43 p.s.i.	38 p.s.i.
	2.0	32 p.s.i.	25 p.s.i.	21 p.s.i.
	2.3	22 p.s.i.	20 p.s.i.	17 p.s.i.
	2.5	19 p.s.i.	17 p.s.i.	14 p.s.i.
Color	Platinum*	Dull Silver	Black	Shiny Silver

*The new color "platinum" color is due to increasing emission regulations in Japan. The new treatment process of the springs creates the new color.

MIKUNI GENUINE PARTS SUPER BN 46 "I"

Diagram No.	Description	Mikuni Part No.
4.	Grommet, Check Valve (2)	BN34/125
7.	Filter	BN44/146
8.	O-Ring, Hi Speed (2)	B30/305
9.	O-Ring, Low Speed (2)	MD12/16
11.	Gasket Valve Body	BN34/123
12.	Check Valve (Clear)	BN34/107
14.	Pin, Arm	VM30/97
15.	Arm (Stainless)	BN38/534
16.	Diaphragm Assembly	BN44/145
61.	Gasket, Pump	BN46I/13
62.	Diaphragm, Pump (Clear)	BN46I/14
63.	O-Ring	616-73002
64.	Check Valve (2)	BN46I/11
66.	Diaphragm, Damper	BN46I/34
67.	Diaphragm, Damper (clear)	BN46I/15
68.	O-Ring	616-73003
69.	O-Ring, Needle Valve	KV/10

MK-BN46I Rebuild Kit

21.	Washer, Aluminum (3)	.BN38/39
25.	Spring (2)	.BN38/344
27.	Washer, Aluminum (2)	.BN38/172
28.	Spring, Low Speed	.BN38/343
29b.	Adjuster, Low Speed	.BN38/166
33.	Plate, Needle Valve Retainer	.BN34/177-GG
34.	Screw with Washer	.CW2=0307-G
37.	Screw	.BV15/121-05-GG
38.	Plate, Valve	.BN34/108-GG
39.	Valve Body Assembly	.BN44/165
40.	Screw (2)	.C5=0414-G
41.	Screw	.C6=0308-K
42.	Cover (Stainless)	.BN44/147
70.	Screw with 2 Washers (4)	.BN34/120-35
73.	Stop Screw, Idle	.BN38I/40
76.	Screw (4)	.C2S=0514
77.	Diaphragm, Accelerator. Pump	.BN40I/22
79.	Body Assembly, Pump	.BN46I/49



ADJUSTER WITH CROSS BAR

This allows simple tuning adjustments, which is not possible with OEM screw.

"I" series 44/46, OEM Yam GP800 & SD 951 Part No.
High Speed cross bar screw SA-100

OEM Yamaha Carb, XL1200LTD, XLT1200, GP1200R Part No.
Low Speed cross bar screw SA-200
High Speed cross bar screw SA-300

OEM Kawasaki Carb, Kawasaki 800SX-R, HX720 Part No.
Low Speed cross bar screw SA-500
High Speed cross bar screw SA-100

OEM Yamaha Carb, Superjet 2004+ Part No.
Low Speed cross bar screw* SA-700
High Speed cross bar screw* SA-800

*Choke must be removed and brass plugs drilled out to install SA-700 and SA-800

MIKUNI GENUINE COMPONENTS SUPER BN 46 "I" TYPE CARB

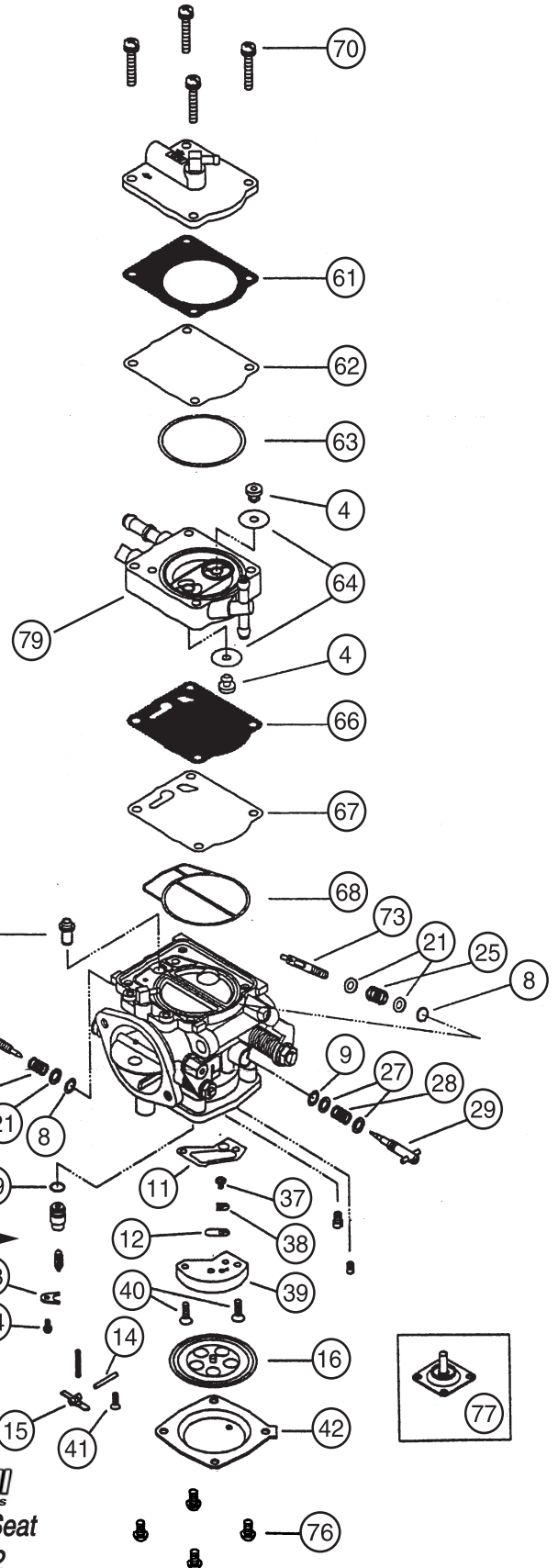

Needle and Seat
See Page 102

For Yamaha GPR Mikuni Carb Repair Kit, see page 104

FOUR STROKE
INTAKE SYSTEMS
ENGINE/GASKETS
EXHAUST
DRIVE LINE HANDLING
ELECTRICAL
WATERLINE /BILGE
STEERING & CONTROLS
BODY
ACCESSORIES SERVICE TOOLS /HARDWARE
CHEMICAL

FOUR STROKE
INTAKE SYSTEMS
ENGINE/GASKETS
EXHAUST
DRIVE LINE HANDLING
ELECTRICAL
WATERLINE /BILGE
STEERING & CONTROLS
BODY
ACCESSORIES
SERVICE TOOLS /HARDWARE
CHEMICAL

Diagram No.	Description	Mikuni Part No.
1.	Gasket, Pump	BN461/13
2.	Diaphragm, Pump (Clear)	BN461/14
3.	O-Ring	616-92014
4.	Check Valve (2 pcs)	999-815-071
5.	Grommet (2 pcs)	BN34/125
6.	Diaphragm, Damper	BN461/34
7.	Diaphragm, Damper (clear)	BN461/15
8.	O-Ring	616-92015
9.	Filter, Fuel	BN44/146
10.	O-Ring, High Speed	B21/156
11.	O-Ring, Low Speed	B21/156
12.	O-Ring, Needle Valve	KV/10
13.	Gasket, Valve Body	BN34/123
14.	Check Valve (clear)	BN34/107
15.	Pin, Arm	VM30/97
16.	Spring, Arm 115 gram	730-03027
17.	Arm (Stainless)	BN38/534
18.	Diaphragm Assembly, Main	BN44/145
39.	Screw	C6=0308-K

MK-BN 44I-YAM

SBN44I/SBN46I REPLACEMENT PARTS

- 19. Screw with 2 Washers (4)**BN34/120-35
- 20. Cover, Pump*Not Available*
- 21. Body Assembly, PumpBN461/49
- 22. Stop Screw, IdleBN38/140
- 23. Washer, Aluminum (3)BN38/39
- 24. Spring (2)BN38/344
- 25. Cap, High Speed Adjuster*Not Available*
- 26. Adjuster, High Speed604-25017
- 27. Washer, Aluminum (2)BN38/172
- 28. Spring, Low SpeedBN38/343
- 29. Adjuster, Low SpeedBN38/477
- 30. Main Jet, 30-240 in increments of 5 (See pg 102) N102.221-SIZE
- 31. Low Jet, 30-160 in increments of 5 (See pg 102) N100.606-SIZE
- 32. ScrewBV15/121-05-GG
- 33. Plate, ValveBN34/108-GG
- 34. Valve, Body AssemblyBN44/165
- 35. Screw (2)C5=0414-G
- 36. **Needle Valve Assembly****SEE PAGE 102**
- 37. Plate, Needle Valve RetainerBN34/117-GG
- 38. Screw w/WasherCW2=0307-G
- 39. ScrewC6=0308-K
- 40. Cover, (stainless, unpainted)BN44/147
- 41. Screw (4)**C2S=0514
- 42. Diaphragm, Accelerator PumpBN40I/22

**Tightening Torque:
Part No. 19: 4.5 N•m (45 kg•cm)
Part No. 42: 3.5 N•m (35 kg•cm)

Note: DO NOT use gasket sealant during assembly.



ULTIMATE CARB GASKETS

Thick "Green" gaskets.

Mikuni	Part No.	Mikuni	Part No.
38mm	9230	48mm	9252
40mm "I" Series*	9235	50mm	9257
44mm	9240	50mm SD951	6740
46mm	9250	"I" Series	

* Does not have OEM alignment holes.



SUPER BN 44I/46I FOR YAMAHA

Rebuild kit for one Super BN44I or BN 46I carburetor.

FITS ONLY: Yamaha Watercraft engine with Power Valve System (Type 60T, 66E, 66V, 67X, 68N)

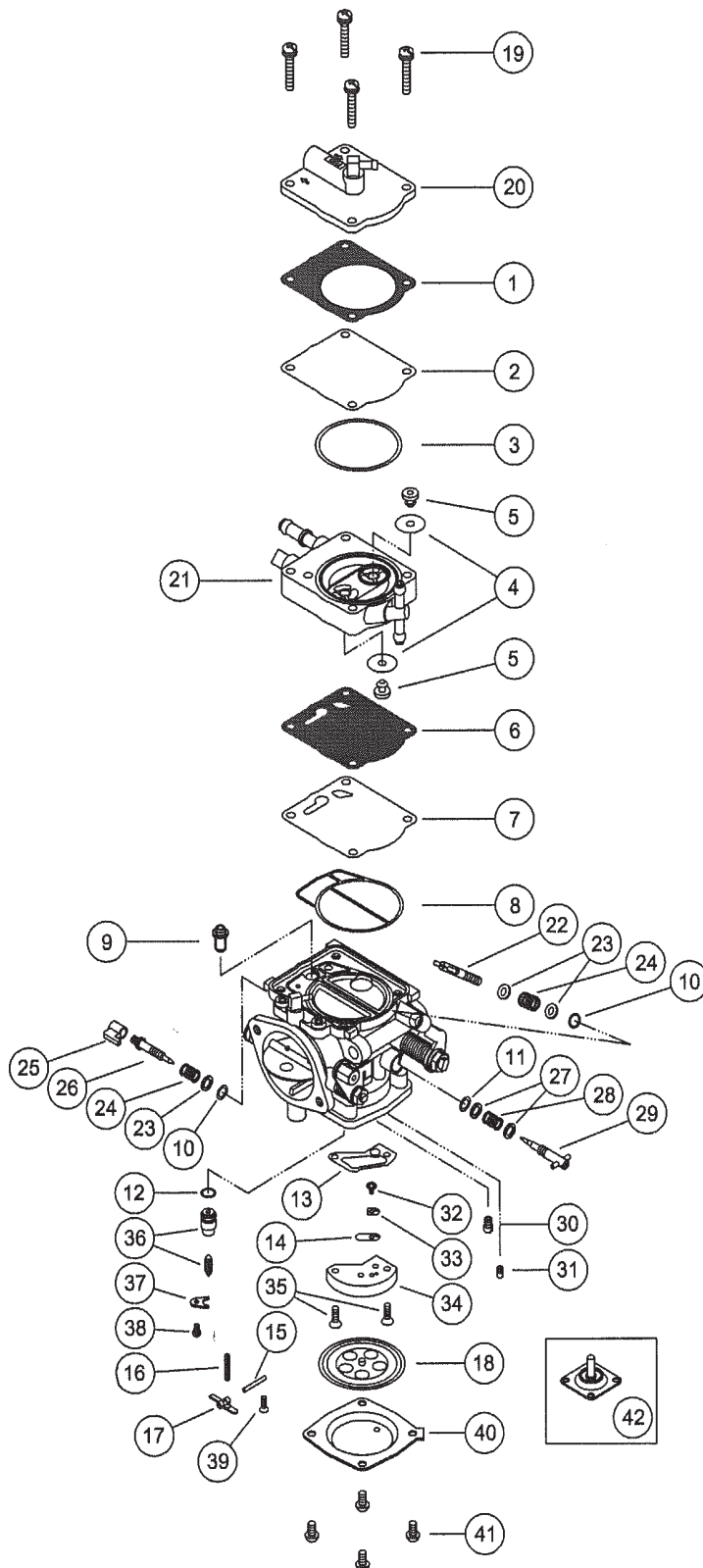



MINI FUEL PUMP BLOCK OFF

Block off plates sold individually, one block off plate only.



DF62-702

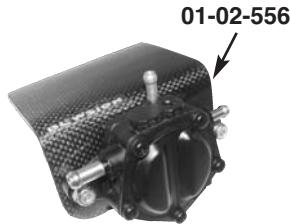

01-02-556

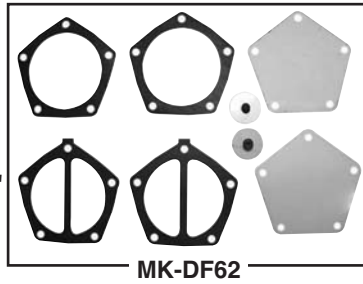

MK-DF62



Description

Mikuni Fuel Pump Block Off
(No bolts are included with the block off)
Blowson Mikuni Fuel Pump Block Off
(Billet aluminum and includes all stainless hardware)

Part No.

BN34/126

01-02-557

MIKUNI HIGH VOLUME FUEL PUMP

16 gallons/65 Liters per hour

Description

Mikuni Fuel Pump (2 outlet) **DF62-702**
Mikuni Fuel Pump Repair Kit **MK-DF62**
Fuel Pump Bracket (Fuel pump is not included) **01-02-556**

Part No.



EXTREME THROTTLE MIKUNI CARB BILLET ADJUSTER KNOBS

Description

Adjuster Knob
for Mikuni Carb (Sold in pairs)

Part No.

SINGLE-CARB-ADJ



MIKUNI PULSE FUEL PUMPS

Mikuni MK Pulse Fuel Pumps are available for use as OEM original equipment in many motorsports applications, including snowmobiles. The benefits of using the Mikuni MK pumps range from fuel-pumping capabilities to freedom of placement on custom powersports vehicles.

The fuel pumps employ an engine's fluctuating crankcase pressure when running to pump fuel from a remote fuel tank to an engine carburetor. In addition, they allow the builder the option of placing the fuel tank in any location not requiring a gravity fuel feed, and there is no need for an auxiliary electric fuel pump.

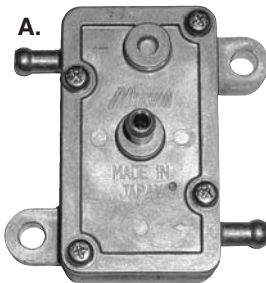

A.

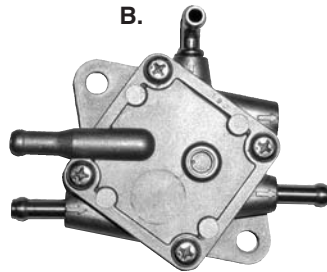

B.

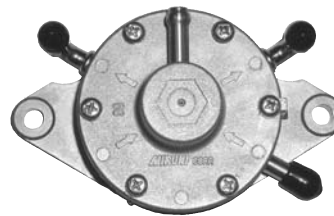

C.

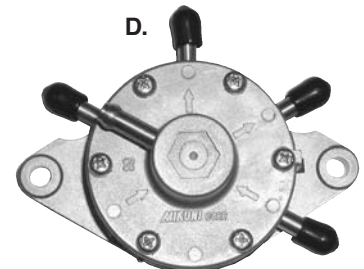

D.

Number of Outlets	Style	Mounting	Flow Rate Liters/HR	Part Number
A. 1	Rectangle	Flush	14	DF44-227
B. 2	Square	Flush	31	DF52-136
C. 2	Round	Flush	35	DF52-73
D. 3	Round	Flush	35	DF52-92

MIKUNI PULSE FUEL PUMP REPAIR KIT

Contents	Description	Quantity	Remarks	Part Number
CW2-0416	Screw	4	w/Washer	MK-DF44 (For DF44-227)
DF44-201/03	Gasket	1	Fiber	
DF44-201/04	Diaphragm	1	Clear	
DF44-201/05	Membrane	1	Thin Rubber	
DF52/105	Gasket	1	Thick Fiber	MK-DF52 (For DF52-73 & DF52-92)
DF52-48/10	Diaphragm	2	Transparent Film	
DF52-48/05	Gasket	1	Thin Rubber	
DF52/113	Gasket	1	Thin Rubber	
DF52/36A	Gasket	1	Thick Fiber	
DF52/27A	Valve	2	Clear	
DF44/26	Grommet	2	Black	

* Mikuni currently does not offer a repair kit for the DF52-136 Pulse Fuel Pump

FOUR STROKE
INTAKE SYSTEMS
ENGINE/GASKETS
EXHAUST
DRIVE LINE HANDLING
ELECTRICAL
WATERLINE /BILGE
STEERING & CONTROLS
BODY
ACCESSORIES
SERVICE TOOLS
HARDWARE
CHEMICAL

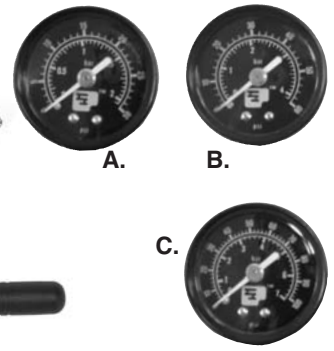

SPIGOT MOUNT FLANGE FOR MIKUNI CARBURETOR

For easier removal and installation of carburetor for jetting and maintenance. Recommended to use with side draft manifold only.

Description	Part No.
Spigot Mount Flange Sea-Doo 800 (Silver Band)	M-VM40-200K

MIKUNI POP-OFF GAUGE

For Accurate adjustment of pop off pressure levels for fine tuning requirements.

Description	Part No.
A. Mikuni 30 lbs. Guage	MK-BN PMP
B. Mikuni 60 lbs. Guage	MK-BN PMP-60
C. Mikuni 100 lbs. Guage	MK-BN PMP-100
D. Replacement Special Thread Brass Fitting	MK-BN/054



MIKUNI TOOL KIT

This handy little kit contains all the tools necessary to make jetting change, perform normal maintenance as well as disassemble and rebuild any Mikuni carburetor.

Description	Part No.
Mikuni Tool Kit	MK-404



MIKUNI POCKET TUNER

A handy pocket-size slide calculator which can be used to determine required jetting changes in Mikuni carburetors due to ambient temperature, altitude or both.

Description	Part No.
Mikuni Pocket Tuner	MK-550-TNR

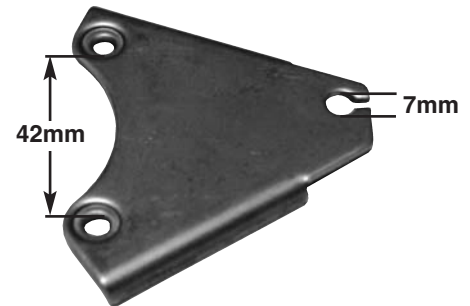

MIKUNI CARBURETOR DIAPHRAGM OR PUMP MOUNT THROTTLE BRACKET

Description	Part No.
Throttle Bracket	BN381/42

HOT PRODUCTS MIKUNI CARBURETOR REPAIR PARTS KIT



Description	Part No.
Mikuni Carburetor Repair Parts Kit	53-2130

Description	Quantity Included	Part No.
Valve Body Assembly	2	BN44/165
Mikuni Carb Screw	10	BV15/121-05-GG
Plate	5	BN34/108-GG
Mikuni Carb Screw	10	C6=0308-K
Clip, SBN38/44/46 Throttle Shaft	5	MK-BN/005
Washer, SBN38/44/46 Throttle Shaft	10	N114.077
Plate, NV Retainer	5	BN34/117-GG
Mikuni Screw w/Spring Washer	10	CW2=0307-G
O Ring Sq BN 35mm	5	616-72001
Mikuni Carb Screw	10	C5=0414-G
O Ring, SBN Dampner	5	616-92007
Mikuni Check Valve	10	BN34/107
Mikuni Stainless Carb Arm	5	BN38/534
Pin	5	VM30/97
Seal, SBN38/44/46 Throttle Shaft	10	N167.126
Mikuni Carb Screw	10	C2S=0514
O Ring	10	KV/10
Check Valve Clear	5	BN34/124
Grommet Check Valve	5	BN34/125
O Ring	10	B30/305
O Ring	10	MD12/16
BN461 O Ring	4	616-73002
BN461 O Ring	4	616-73003
Mikuni Valve Body Gasket	5	BN34/123
Mikuni SBN Carb Fuel Filter	10	BN44/146

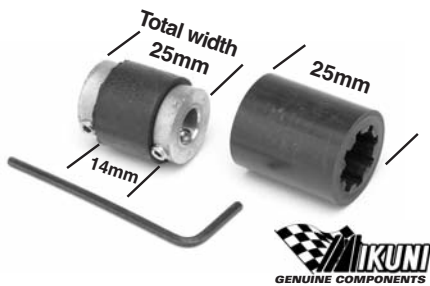

MIKUNI DUAL CARBURETORS LINKAGE KIT

The Mikuni Dual linkage kit includes all items as pictured: One complete linkage, one allen wrench and two dampners (14mm & 25mm) are included.

Description	Part No.
Mikuni Dual Linkage Kit	MK-BN/001



HOT PRODUCTS CARBURETORS LINKAGE

Linkage Kit	Part No.
Mikuni Carburetor Linkage	53-0622



HOT PRODUCTS CARBURETORS LINKAGE SLEEVES

Sleeve Only	Part No.
3/4"	19mm 53-9906
1"	25mm 53-9916
2-3/16"	56mm 53-9917
6"	152mm 53-9918



JETWORKS LINKAGE

Using 120mm center to center aftermarket dual S/BN carburetor applications. It is made to have zero backlashes and will not compress after age.

Description	Part No.
120mm center to center	LK-2



TBM CARBURETOR SHAFT COLLARS

Designed to replace the e-clips that commonly break allowing the carburetor shaft to vibrate side to side damaging the butterfly's and carburetor bodies. Manufactured from stainless steel for corrosion prevention, the two-piece design allows installation without disassembling the carburetors.

Description	Part No.
Carburetor shaft collars	TBM108

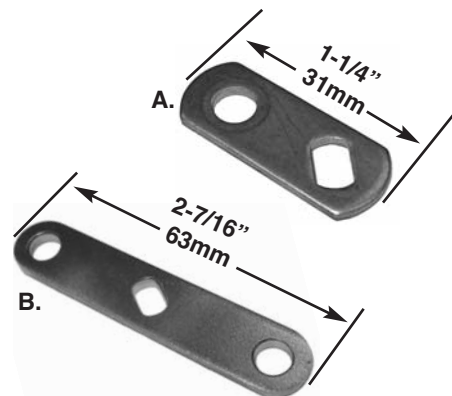

THROTTLE LINKAGE ARM

Description	Part No.
A. Throttle Arm	53-0609
B. Throttle Linkage Arm	53-0608

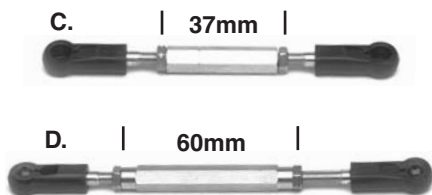

MIKUNI GENUINE OEM STYLE LINKAGE RODS

Description	Part No.
C. Sea-Doo XP800	BN38/573-1A
D. Sea-Doo 951	BN38/573-1C

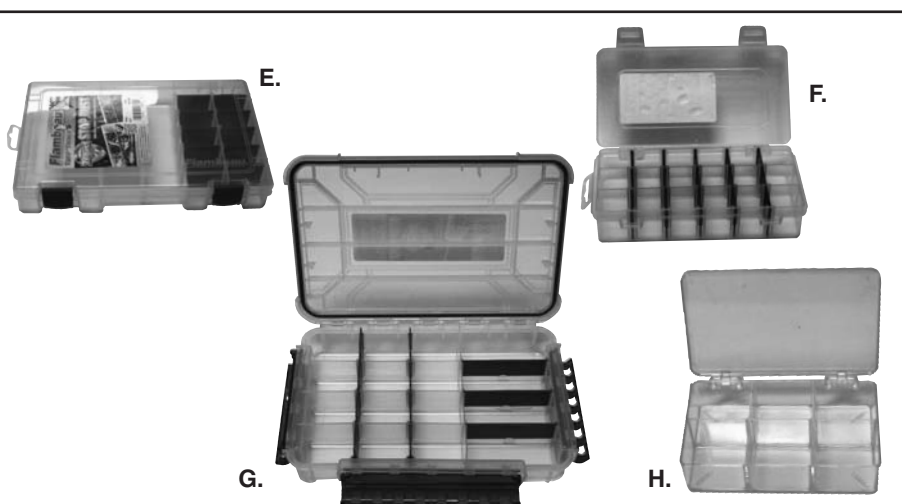

HOT PRODUCTS COMPARTMENT BOXES (STORAGE BOXES)

Use for valve shim storage, small parts, electrical connectors and carburetor jets. Sold each.

Compartments	Box Material	Width	Height	Depth	Part No.
E. 36	Translucent Polypropylene	10-5/8"	1-9/16"	6 5/8"	53-2122*
F. 18	Translucent Polypropylene	6-11/16"	3-5/16"	1-5/16"	53-2123*
G. 16	Translucent Polypropylene	11"	6-1/4"	1-1/2"	53-2143*
Tuff 'tainer Waterproof Box - features a triple locking lid to prevent any spills					
H. 6	Clear Hard Plastic	4-1/2"	2-3/4"	1"	53-2144

*Features Blue "Zerust" Corrosion Protection Dividers/Tabs



ADA RACING THROTTLE CABLE DRUM FOR MIKUNI

ADA Racing billet throttle drum for Mikuni carburetors allows the use of any throttle cable and bracket on Mikuni carburetors. 9 positions, 18mm throw.

Description	Color	Part No.
ADA Racing Cable Drum 18mm Throw	Black	30-110100
ADA Racing Cable Drum 18mm Throw	Silver	30-110190
ADA Racing Cable Drum 18mm Throw	Red	30-110120
ADA Racing Cable Drum 18mm Throw	Blue	30-110110

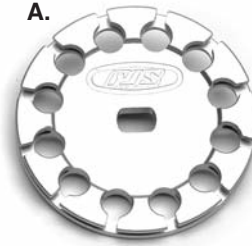

PJS THROTTLE CABLE DRUM FOR MIKUNI

PJS Drums features a center web thin enough to allow use of nut with lock washer. "D" slot match the throttle shaft for a perfect fit. 12 positions and available in 20mm or 25mm throws, anodized clear.

Description	Part No.
A. Standard Size (20mm throw)	CB-00200
B. Oversized (25mm throw) for Oil Injection and Stock Carburetors of Yamaha GP/XL	CB-00205

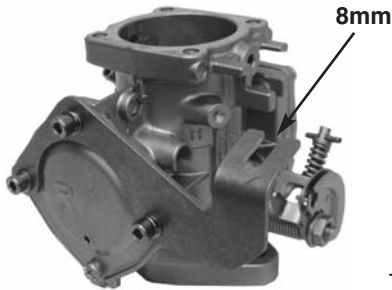

PJS UNIVERSAL DIAPHRAGM MOUNT THROTTLE CABLE BRACKET

The PJS carb diaphragm side throttle bracket was developed with a 8mm cable mount for Yamaha and created with additional material to allow for modification to 10mm for Kawasaki throttle cables. Recommended to be used with a ADA Racing Cable Drum shown above.

Description	Cable Size	Part No.
Universal Throttle Cable Bracket	8mm	CB-00210

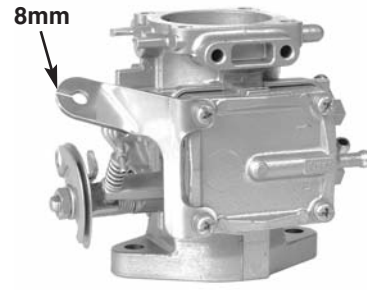

HOT PRODUCTS UNIVERSAL PUMP MOUNT THROTTLE CABLE BRACKET

This carb pump side throttle bracket was developed with a 8mm cable mount for Yamaha and created with additional material to allow for modification to 10mm for Kawasaki throttle cables. Recommended to be used with a ADA Racing Cable Drum shown above.

Description	Cable Size	Part No.
Pump Mount Universal Throttle Cable Bracket	8mm	53-3315



MIKUNI THROTTLE PULL CABLE CONVERSION

This piece will allow you to convert a Mikuni carb from the old pull style cable to a barrel cable. Kit includes: Mikuni half moon barrel cable pull, Mikuni lock washer and Mikuni throttle shaft nut. Color: Silver.

Description	Part No.
Mikuni Throttle Pull Arm Cable Conversion	53-0630



MOTOINE SOFT SPRING FOR MIKUNI CARBS

New Motoine Mikuni spring is 2/3 softer than original spring and reduces thumb and/or finger throttle fatigue.

Description	Part No.
Motoine Soft Spring	MR-00013



ADA RACING CABLE BRACKET FOR OEM CARBS

Kawasaki 750/800 throttle cable/choke cable bracket. For use with stock carbs when using the ADA Racing billet girdle head kit. This bracket has the throttle cable mount moved up, so it does not interfere with the girdle bracket.

Description	Part No.
ADA Bracket	KA800BRK-CARB

THROTTLE CABLES

Manufacturer	Year	O.E. No.	Part No.
KAWASAKI			
440 JS	1977-1986	54012-3001	58-3121
550 JS	1982-1986	54012-3001	58-3121
550 SX	1991-1995	54012-3725	002-032
650 SX	1988-1990	54012-3711	002-066
		54012-3706	
650 SX	1991-1993	54012-3727	002-028
		54012-3731	
650 TS	1989-1990	54012-3719	002-030
650 TS	1991-1995	54012-3733	002-035
650 X2	1986-1987	54012-3704	002-062
650 X2	1988-1990	54012-3715	002-063
650 X2	1991-1995	54012-3728	002-033
750 SS_XI	1996-1997	54012-3744	002-034-01
750 SS_XI	1993-1995	54012-3738	002-029
750 STS	1995-1997	54012-3744	002-034-01
750 STX	1998	54012-3744	002-034-01
750 SX	1992-1995	54012-3732	002-034
750 SXI	1995	54012-3743	002-031-01
750 SXI	1996	54012-3748	002-032-01
750 SXI Pro	1998-2002	54012-3753	002-032-01
750 XI Sport	1998-1999	54012-3744	002-034-01
750 ZXI	1995-1997	54012-3747	002-033-02
		54012-3754	
800 SX-R	2003-2011	54012-3773	002-032-02
900 STS	2001-2002	54012-3756	002-034-02
900 STX	1997-1998	54012-3744	002-034-01
900 STX	1999-2003	54012-3756	002-034-02
900 STX	2004-2006	54012-3769	002-034-04
900 ZXI	1995-1997	54012-3754	002-033-02
		54012-3747	
1100 STX	1998	54012-3756	002-034-02
1100 STX DI	2000-2002	54012-3765	002-034-03
1100 STX DI	2003	54012-3769	002-034-04
1100 Ultra 130	2001-2002	54012-3767	002-097-02
1100 Ultra 130	2003-2004	54012-3770	002-097
1100 ZXI	1996-1997	54012-3747	002-033-02
		54012-3754	
1100 ZXI	1998-2003	54012-3758	002-033-03
1200 STX-12F	2003-2007	54012-3771	002-034-05
1200 STX-R	2002-2004	54012-3768	002-097-01
1200 Ultra 150	1999-2002	54012-3764	002-097-03
1200 Ultra 150	2003-2005	54012-3768	002-097-01
1500 STX	2009-2010	54012-3771	002-034-05
1500 STX-15F	2004-2013	54012-3771	002-034-05
1500 Ultra 250X	2007-2008	54012-3771	002-034-05
1500 Ultra 260LX	2009-2010	54012-3771	002-034-05
1500 Ultra 260X	2009-2010	54012-3771	002-034-05
1500 Ultra 300LX	2011-2012	54012-3777	002-034-06
1500 Ultra 300X	2011-2012	54012-3777	002-034-06
1500 Ultra LX	2007-2013	54012-3771	002-034-05
SEA-DOO			
580 GT	1990-1991	277000098	002-037
580 GTS	1992-1993	277000144	002-039
580 GTS	1994-1995	277000271	002-039-01
580 GTX	1992-1993	277000137	002-038
580 GTX	1992-1993	277000144	002-039
580 SP	1991	277000098	002-037
580 SP	1992-1993	277000137	002-038
580 SP	1992-1993	277000144	002-039
580 SP	1994	277000275	002-038-01
580 SP	1994-1996	277000252	002-039-02
580 SP	1995	277000253	002-039-05
580 SP	1996	277000468	002-039-03
580 SPI	1993	277000137	002-038
580 SPI	1993	277000144	002-039
580 SPI	1994	277000275	002-038-01
580 SPI	1994-1996	277000468	002-039-02
		277000252	
580 SPI	1995	277000253	002-039-05
580 SPX	1993	277000137	002-038
580 SPX	1993	277000144	002-039
580 XP	1991	277000098	002-037
580 XP	1992	277000137	002-038
580 XP	1992	277000144	002-039
650 GTX	1994-1995	277000271	002-039-01
650 SPX	1994	277000275	002-038-01
650 SPX	1994-1995	277000252	002-039-02
		277000468	
650 SPX	1995	277000253	002-039-05
650 XP	1994	277000275	002-038-01
650 XP	1994	277000253	002-039-05
650 XPI	1994	277000275	002-038-01
650 XPI	1994	277000253	002-039-05
720 GS	1997	277000614	002-038-03
720 GS	1998-2001	277000727	002-038-04
720 GSI	1997	277000614	002-038-03
720 GTI	1997	277000649	002-038-05
720 GTI	1997	277000614	002-038-03
720 GTI	1998-2001	277000727	002-038-04
720 GTS	1997	277000614	002-038-03
720 GTS	1997	277000649	002-038-05
720 GTS	1998-2000	277000710	002-038-06
720 GTS	2001	277000727	002-038-04
720 SP	1997	277000252	002-039-02
		277000468	
720 SP	1997	277000468	002-039-03
720 SPI	1996	277000468	002-039-03
720 SPX	1996-1997	277000252	002-039-02
		277000468	
720 SPX	1996-1997	277000468	002-039-03
720 XP	1995	277000252	002-039-02
		277000468	
800 GSX	1996-1997	277000596	002-039-04
800 GTI LE RFI	2003-2005	277000847	002-036-02
800 GTI RFI	2004-2005	277000847	002-036-02
800 GTX RFI	1999-2002	277000847	002-036-02

Manufacturer	Year	O.E. No.	Part No.
SEA-DOO continued			
800 SPX	1998-1999	277000252	002-039-02
		277000468	
800 SPX	1998-1999	277000468	002-039-03
800 XP	1995-1996	277000252	002-039-02
		277000468	
800 XP	1995-1996	277000468	002-039-03
951 GSX	1998	277000781	002-036-01
951 GTX DI	2000-2003	277000851	002-036-03
951 GTX Ltd.	1998	277000781	002-036-01
951 RX DI	2000-2003	277000851	002-036-03
1503 GTI	2006-2007	277001170	002-036-04
1503 GTI 130	2008-2010	277001083	002-036-04
1503 GTI 155	2010	277001122	002-036-04
1503 GTS Pro 130	2011	277001122	002-036-04
1503 GTX 155	2008-2010	277001122	002-036-04
1503 GTX 4-Tec	2003-2007	277001122	002-036-04
1503 Wake 155	2008-2010	277001122	002-036-04
1503 GTX 215	2008-2009	277001121	002-036-05
1503 GTX BVIC	2007	277001121	002-036-05
1503 GTX Ltd. SC	2003-2006	277001121	002-036-05
1503 RXT	2005-2006	277001121	002-036-05
1503 RXT 215	2008	277001121	002-036-05
1503 RXT BVIC	2007	277001121	002-036-05
1503 Wake 215	2008-2009	277001121	002-036-05
1503 RXP	2005-2006	277001070	002-036-06
1503 RXP 215	2008-2009	277001070	002-036-06
1503 RXP BVIC	2007	277001070	002-036-06
1503 RXP Supercharged	2004	277001070	002-036-06
YAMAHA			
500 Wave Jammer	1989-1990	EW3-67252-00-00	002-052
		EW3-67252-01-00	
		EW3-67252-02-00	
500 Wave Runner	1989	EU0-U7252-01-00	05-0226
500 Wave Runner	1991-1993	EU0-U7252-00-00	05-0226
650 LX	1991-1993	EU0-U7252-00-00	05-0226
650 Super Jet	1990-1993	EU0-U7252-00-00	05-0226
650 VXR	1991-1993	EU0-U7252-00-00	05-0226
650 VXR	1995	EU0-U7252-00-00	05-0226
650 Wave Runner III	1990-1996	EU0-U7252-00-00	05-0226
700 FX1	1994-1995	EU0-U7252-00-00	05-0226
700 Super Jet	1995	EU0-U7252-00-00	05-0226
700 Super Jet	1996-2012	GM6-67252-00-00	002-055-06
700 VXR	1993-1994	EU0-U7252-00-00	05-0226
700 Wave Blaster	1993-1995	EU0-U7252-01-00	05-0226
700 Wave Blaster	1996	GH1-67252-01-00	002-053
		GH1-67252-00-00	
700 Wave Raider	1995	GJ1-U7252-00-00	002-057
700 Wave Raider	1996-1997	EU0-U7252-00-00	05-0226
		EU0-U7252-01-00	
700 Wave Runner Deluxe	1995	GJ1-U7252-00-00	002-057
700 Wave Runner	1994	GH1-67252-00-00	002-053
		GH1-67252-01-00	
700 Wave Runner III	1994-1996	EU0-U7252-00-00	05-0226
		EU0-U7252-01-00	
700 Wave Venture	1995-1998	GJ1-U7252-00-00	002-057
700 XL	1999-2004	F0M-U7252-00-00	002-055-05
760 GP	1999-2000	GP7-U7252-00-00	002-053-01
760 Wave Raider	1996	GP2-U7252-00-00	002-055-07
760 Wave Runner	1997-1998	GP7-U7252-00-00	002-053-01
760 Wave Venture	1997	GP2-U7252-00-00	002-055-07
760 XL	1998-1999	GP2-U7252-00-00	002-055-07
800 GP	1998-2000	66E-67252-00-00	002-055-02
800 GP	2001-2005	68A-67252-00-00	002-055-04
800 XL	2000-2001	66E-67252-00-00	002-055-02
800 XLT	2002-2003	66E-67252-00-00	002-055-02
1000 FX	2005	6B6-26311-00-00	002-055-10
		6B6-26311-02-00	
1000 FX	2006-2008	6B6-26311-11-00	002-055-11
		6B6-26311-12-00	
1000 FX 140	2002-2004	60E-26311-00-00	002-055-01
1000 FX Cruiser	2005	6B6-26311-02-00	002-055-10
		6B6-26311-00-00	
1000 FX Cruiser	2006-2008	6B6-26311-12-00	002-055-11
		6B6-26311-11-00	
1100 FX Cruiser HO	2004-2005	6B6-26311-00-00	002-055-10
		6B6-263-11-02-00	
1100 FX Cruiser HO	2006-2008	6B6-26311-11-00	002-055-11
1100 FX Cruiser HO Anniv.	2006	6B6-26311-12-00	
1100 FX HO	2004-2005	6B6-26311-00-00	002-055-10
		6B6-26311-02-00	
1100 FX HO	2006-2008	6B6-26311-11-00	002-055-11
		6B6-26311-12-00	
1100 VX	2007-2009	6D3-26311-00-00	002-055-12
1100 VX Cruiser	2007-2009	6D3-26311-01-00	002-055-12
1100 VX Deluxe	2005-2009	6D3-26311-02-00	002-055-12
1100 VX Sport	2005-2009	6D3-26311-02-00	002-055-12
1100 Wave Runner	1995-1996	GJ1-U7252-00-00	002-057
1100 Wave Venture	1996-1997	GJ1-U7252-00-00	002-057
1200 GP	1997-1999	GP8-U7252-00-00	002-055-08
1200 GP	2000-2002	66V-67252-00-00	002-055-03
1200 SUV	1999-2004	GU5-U7252-00-00	002-055-09
		F1D-67252-00-00	
1200 XL	1998	GP8-U7252-00-00	002-055-08
1200 XL	1999-2001	66V-67252-00-00	002-055-03
1200 XLT	2002-2005	66V-67252-00	



KEIHIN GENUINE CARBURETOR REBUILD KITS

Kits include all necessary gaskets, diaphragms, and hardware required to rebuild Keihin carburetors.

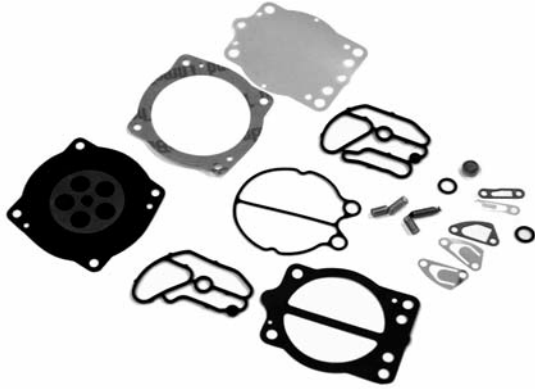

Description **Part No.**
38/40mm OEM Type & 42mm CDKII **53-2103**

POLARIS • Hurricane 700 96-97, SL/SLT 700 96-97, SLH 700 96-97, SL900 96-97, SL/SLTX 1050 96-00, SLXH 1050 98-99, Genesis 99-00, 1200Pro 00, Virage/TX 00

KAWASAKI • JS440 91-92, JS550SX 91-95, 650TS 89-96, 650SC 90-95, 750SX 92-95, 750SXI 95, 750SS 92-98, 750XI 93-97, 750XIR 94, 750ST 94-95, 750STS 95-97, 750ZXI 95-98, 900ZXI 95-97, 900STX 97-99, 1100ZXI 96-97



Description **Part No.**
28mm OEM Type **53-2100**

KAWASAKI • J650 SX 1986-91 & 650 X-2 1986-91

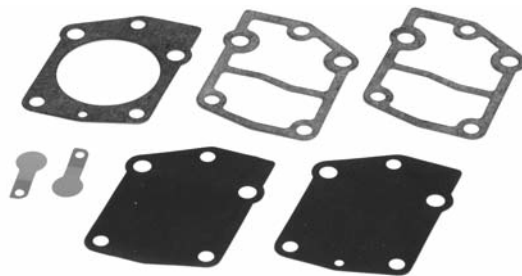

KEIHIN FUEL PUMP REBUILD KIT

Includes all parts necessary to rebuild the Keihin fuel pump. Fits Kawasaki 650SX 1986-91, 650X2 1989-91.

Description **Part No.**
Keihin Fuel Pump Rebuild Kit **53-2105**



MIKUNI SBN CARBURETOR ADAPTERS FOR KEIHIN INTAKE MANIFOLDS

This adapter allows you to run a Mikuni SBN 44mm or 46mm carburetor on your Keihin intake manifold.

Note: You MUST bore your intake to match the new larger carburetor size.

Description **Part No.**
Watcon Keihin Mikuni Intake Manifold Adapter **ADPT-K**

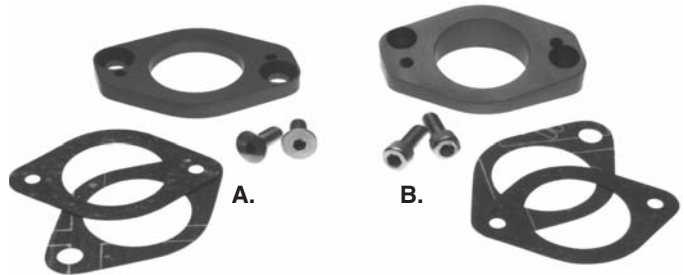

KEIHIN CARBURETOR ADAPTERS FOR MIKUNI CARBURETOR MANIFOLDS

Description **Part No.**
A. This adapter allows mounting of Keihin CDKII 38, 42 carburetor to any popular O.E. or aftermarket 44mm Mikuni intake manifold. **53-3305**

**The carb will stand straight up when using this adapter - the carb is just rotated a few degrees to clear the adapter mounting bolts.*

Description **Part No.**
B. This adapter is designed to mount to the Keihin CDKII 38, 42 carburetor at an angle specifically for the Kawasaki JS440/550 piston port engine. **53-3308**

**A short air filter is required for to prevent rubbing on the inside of the hood*



CARBURETOR JETS

Keihin Low Jets		Keihin Main Jets	Keihin Main Jets	
P/# (N424-35-size)	P/# (N424-27-size)	P/# (N424-27-size)	P/# (N424-36-size)	
40	95	150	100	155
45	100	155	102	158
50	102	160	105	160
52	105	165	108	162
55	108	170	110	165
58	110	175	115	170
60	115	180	118	172
62	118	185	120	175
65	120	190	125	178
68		195	130	180
70		200	135	182
72		(for CDCV)	138	185
75			140	190
80			145	195
85			148	200
90			150	
			152	

GENUINE KEIHIN CARBURETOR PARTS



Description	Diagram	Keihin Part No.
Screw	102	N114-03060
Adjust Screw (Main)	103	DISCONTINUED
Adjust Screw (Slow)	107	Z014-0670
Check Valve	110	1242-809-2000
Gasket	111	1202-823-2000
Cover	113	1230-827-2000
Diaphragm	114	1201-813-2100
Screw	115	93500-04008-1H
Arm Spring	116 A	1290-966-2000
Arm Spring	116 B	1290-947-2000
Screw	117	4114-001-1200
Arm Pin	118	16152-KG8-9010M1
Float Arm	119	DISCONTINUED
Needle Valve	120	1062-818-2000
Gasket	121	1202-822-2000
U-Ring	123	0903-809-6000
Lever Pin	126	DISCONTINUED
O-Ring	128	0901-055-6000
Screen	130	2009-811-2100
Diaphragm	134	1201-825-2000
O-Ring	137	0901-841-6000
Gasket	139	1202-851-2000
Screw	140	4129-826-1900

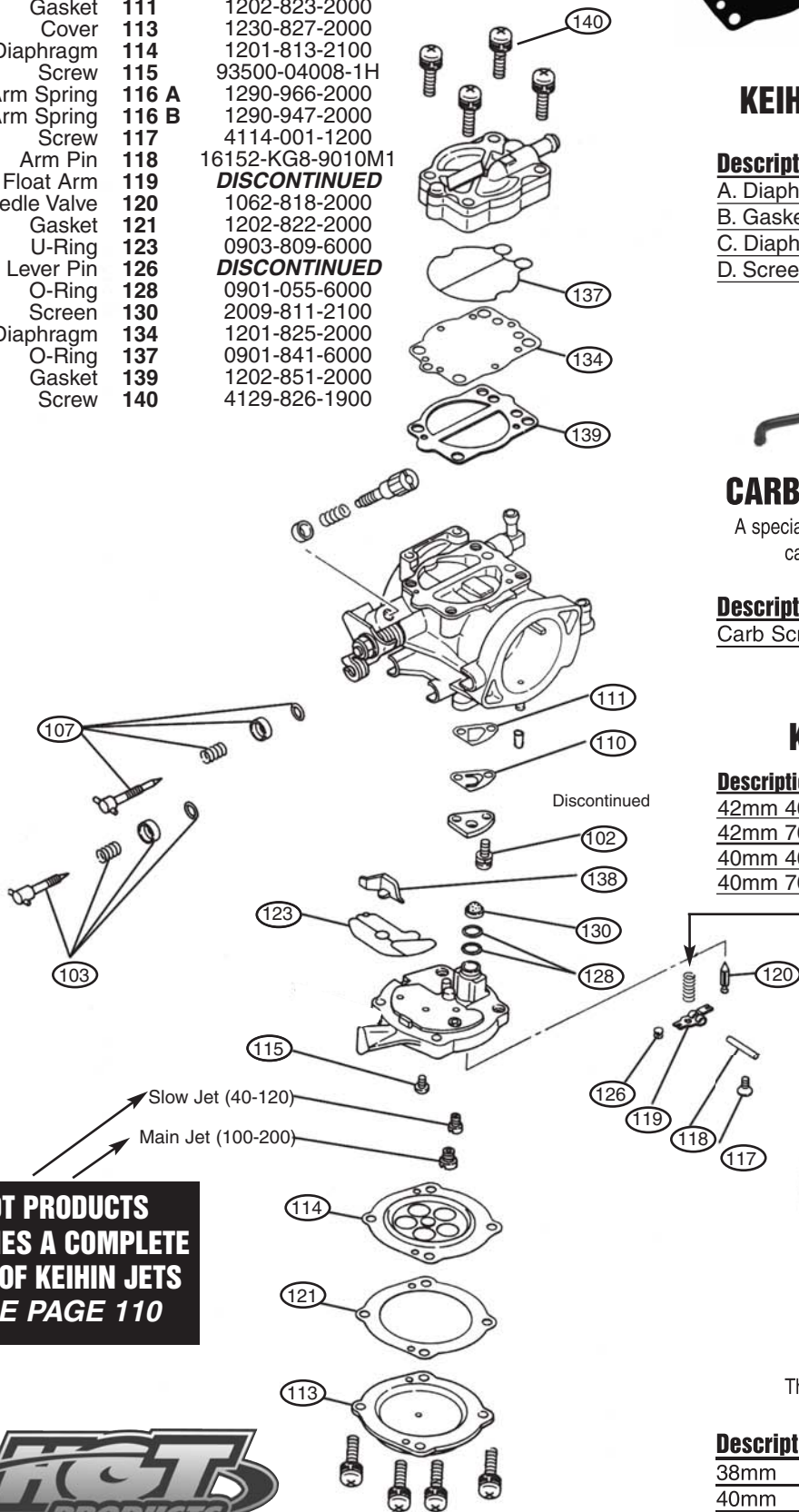

**HOT PRODUCTS
CARRIES A COMPLETE
LINE OF KEIHIN JETS
SEE PAGE 110**

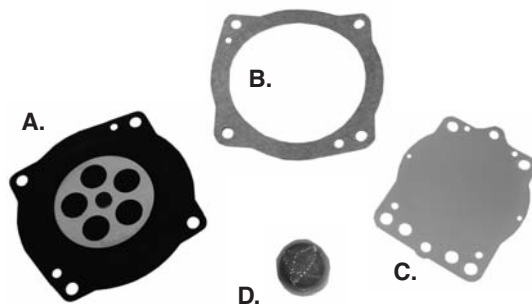

KEIHIN DIAPHRAGM & FILTER

Description	Part No.
A. Diaphragm Assembly	1201-813-2100
B. Gasket	1202-822-2000
C. Diaphragm	1201-825-2000
D. Screen Filter	2009-811-2100



CARB SCREW ADJUSTING TOOL

A special 90-degree screwdriver, designed to adjust carburetors of triple-cylinder watercraft.

Description	Part No.
Carb Screw Adjusting Tool	08-0119

KEIHIN ARM SPRINGS

Description	Length	Part No.
42mm 40 gram	3/8"	1290-966-2000
42mm 70 gram	7/16"	1290-947-2000
40mm 40 gram	5/16"	1290-992-2000
40mm 70 gram	11/32"	1290-961-2000



ULTIMATE KEIHIN CARB GASKETS

Thick "Green" gaskets for Keihin carbs.

Description	Part No.
38mm	9200
40mm	9205
42mm	9220

FOUR
STROKE

INTAKE
SYSTEMS

ENGINE/
GASKETS

EXHAUST

DRIVE LINE
HANDLING

ELECTRICAL

WATERLINE
/BILGE

STEERING
& CONTROLS

BODY

ACCESSORIES

SERVICE TOOLS
/HARDWARE

CHEMICAL



Generation III
Booster Technology

NOVI-TEC 48MM CARBURETOR KIT

The new Novi-Tec Generation III booster design offers precise and consistent tuning in all atmospheric conditions and minimizes sonic wave reverse fueling effects. The new design offers maximum performance by maintaining a high flow capacity for today's large displacement engines.

It is designed to create the most precise high-flow air/fuel delivery system available. The Novi-Tec Generation III design optimally meters air and fuel flowing into the combustion chambers to produce maximum power at all throttle ranges, virtually eliminating hesitation and bogging, while maximizing combustion efficiency.

The new Novi-Tec PWC Carburetor with Generation III booster technology is virtually a mechanical "Smart Carb."

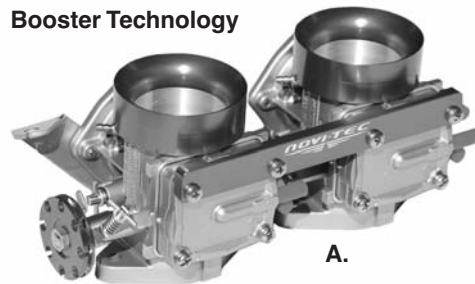

A.

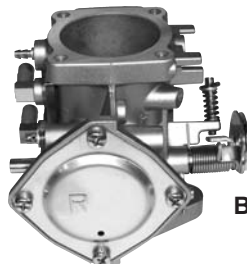

B.



C.

Yamaha	Part No.
A. Yamaha 701/760 Dual 48XR	DY48XRF-S/S
Yamaha 1100/1200 Triple 48XR	TY48XRF-S/S

Free Style	Part No.
B. Free Style Single	48XRF-FS

Kawasaki	Part No.
Kawasaki 750/800 Dual 48XR	DK48XRF-S/S
C. Kawasaki 1100/1200 Triple 48XR	TK48XRF-S/S



DASA CARBURETOR

DASA starts with the Mikuni Super-BN Carburetors, each DASA Carburetor is machined and hand assembled to the Dasa specifications. At the heart of the carburetor is the DASA fuel atomizer, providing peak performance under all riding conditions. Hesitation and bogging are eliminated while delivering explosive acceleration and excellent top speed. Each carb kit includes a zero backlash coupler, throttle linkage and throttle drum.

Dasa recommends a Billet DASA Intake Manifold and the Hot Products Tornado Flame Arrestors.

Carb specs:

Twins will have: 135 P, 125 M, 2.5 N&S w/ 115gm spring
Triples will have: 140 P, 130 M, 2.5 N&S w/ 115gm spring

Description	Part No.
DASA 48mm Single Carburetor	BN-4800
DASA 48mm Dual Carburetor	BN-4802
DASA 48mm Triple Carburetor	BN-4803

* Intake manifold not included

BN-4802



Carburetor
Intake
Manifold
Speed Plate
Plate Shown
is Not
Included

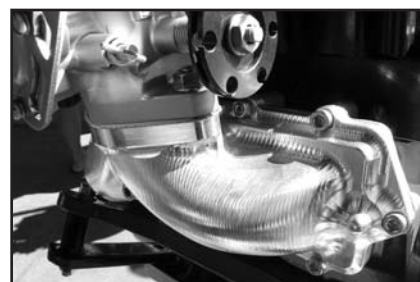

DASA Single
Carb Set-Up

48MM BUTTERFLY

No butterfly screws are included.

Description	Part No.
Jet Works 48mm Butterfly	48-012
Novi 48mm Butterfly 12°	TP-48-12
Novi 48mm Butterfly 13.5°	TP-48-13.5
DASA 48mm Butterfly	BN-48F





HOT PRODUCTS KAWASAKI SINGLE MIKUNI CARBURETOR KITS

Kawasaki	Carb	Flame Arrestor	Part No.
650 SX/X2	Mikuni 44mm	Tau Ceti	53-0650
650 SX/X2	Mikuni 46mm	Tau Ceti	53-0660
750 All	Mikuni 44mm	Tau Ceti	53-0820
750 All	Mikuni 46mm	Tau Ceti	53-0825

All carburetor kits are assembled with Hot Products Tornado Series Filters, the filter size and shape is the best fit based on the watercraft model.

HOT PRODUCTS SEA-DOO DUAL CARBURETOR KITS

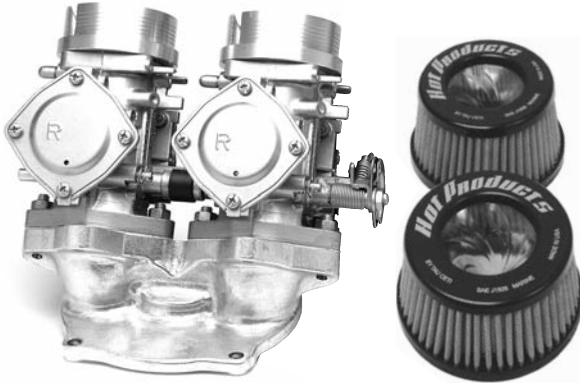

Sea-Doo	Carb	Flame Arrestor	Part No.
720	Mikuni 44mm	K&N	53-0915
720	Mikuni 46mm	K&N	53-0916
800	Mikuni 44mm	K&N	53-0925
800	Mikuni 46mm	K&N	53-0926

720 Kits also fit 650 & 580 Engines. Please specify for proper jetting.

All carburetor kits are assembled with Hot Products Tornado Series Filters, the filter size and shape is the best fit based on the watercraft model.



HOT PRODUCTS YAMAHA AND KAWASAKI DUAL & TRIPLE MIKUNI CARBURETOR KITS



Yamaha	Carb	Flame Arrestor	Part No.
701 W/Rdr/760 (62T)	Mikuni 44mm	Tau Ceti	53-0975
701 W/Rdr/760 (62T)	Mikuni 46mm	Tau Ceti	53-0974
1100/1200	Mikuni 44mm	Tau Ceti	53-0980
1100/1200	Mikuni 46mm	Tau Ceti	53-0992

Kawasaki	Carb	Flame Arrestor	Part No.
750	Mikuni 44mm	Tau Ceti	53-0830
750	Mikuni 46mm	Tau Ceti	53-0840
1100	Mikuni 44mm	Tau Ceti	53-0880
1100	Mikuni 46mm	Tau Ceti	53-0890

All carburetor kits are assembled with Hot Products Tornado Series Filters, the filter size and shape is the best fit based on the watercraft model.



HOT PRODUCTS PREMIUM CARBURETOR KITS

Includes Mikuni carburetors, DASA billet manifold, Jetworx linkage, PJS throttle drum and Hot Products Tornado Series 2-1/2" Filters

Yamaha	Carb	Part No.
701/760 (62T)	Mikuni 44mm	53-0977
701/760 (62T)	Mikuni 46mm	53-0978

Kawasaki	Carb	Part No.
1100	Mikuni 44mm	53-0894
1100	Mikuni 46mm	53-0896

SINGLE INTAKE MANIFOLDS FOR MIKUNI CARBURETORS

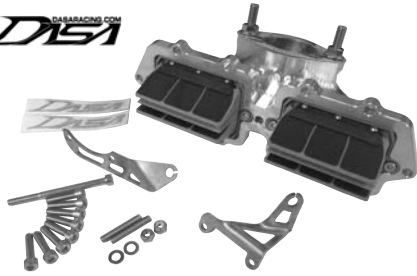

This billet single intake manifold will fit on Y701/760 cylinder. Designed for Moto Tassinari V-Force 2 Reeds, which are sold separately. Fits Mikuni 44-50mm carbs.

Includes carburetor mounting studs, nuts and gaskets.

Includes carburetor mounting studs and nuts.

Yamaha	Part No.
Single Manifold V-2 Design	IN-7004
V-FORCE 2 Reed Kit	V2W140-2

Kawasaki	Part No.
650 All	53-0651

Kawasaki	Part No.
750 All	53-0827

DUAL INTAKE MANIFOLDS FOR MIKUNI CARBURETORS



**Note: These manifolds are compatible with Moto Tassinari V-Force 3 Reed Sets based on the Reed stuffers that are supplied and match perfectly to these R&D intake manifolds.*



R&D SUPERJET INTAKE MANIFOLD KIT

Yamaha	Part No.
701(62T) W/Rdr/760 With Billet Carb. Plate for OEM Reed (Center to Center 120 mm)	222-76000
Mounting Plate Gasket	12-0010

R&D 800 SXR INTAKE MANIFOLD KIT

Kawasaki	Part No.
800SX-R with Billet Carb. Plate for OEM Reed (Center to center 120mm)	231-75146
Mounting Plate Gasket	12-0010



IM-001KIT

**Note: *Kit includes (1) precision cast aluminum intake manifold, (2) "EV" RAD valves, (1) carb adapter plate and all necessary installation hardware.*



IM-002AKIT

BOYESEN EXTREME VELOCITY SUPERJET INTAKE KIT & RAD VALVES

Yamaha	Part No.
701 Superjet 96-08, Extreme Velocity Intake Kit*	IM-001KIT
Extreme Velocity Intake Manifold Only	IM001
"EV" RAD Valves Kit (2 Valves per Kit)	RAD-131A
Replacement RAD Reed for RAD-131A**	PSR-131A
IMK-001 Intake Manifold/Reed Gasket Only	IMG-001
Carb Speed Plate O-Ring (Sold Individually)	IM-034VR
Reed Valve to Manifold O-Ring (Sold Individually)	IM-139VR

**PSR-131A is sold per reed block (2 required for complete engine)

BOYESEN EXTREME VELOCITY 800 SXR INTAKE KIT & RAD VALVES

Kawasaki	Part No.
800SX-R 03-08, Extreme Velocity Intake Kit*	IM-002AKIT
Extreme Velocity Intake Manifold Only	IM002
"EV" RAD Valves Kit (Single Valve)	RAD-113
Replacement RAD Reed for RAD-113**	PSR-131A
IMK-001 Intake Manifold/Reed Gasket Only	IMG-002
Carb Speed Plate O-Ring (Sold Individually)	IM-034VR
Reed Valve to Manifold O-Ring (Sold Individually)	IM-139VR

**PSR-131A is sold per reed block (2 required for complete engine)



DASA BILLET ALUMINUM DUAL YAMAHA INTAKE MANIFOLD KIT

Designed by the billet masters at DASA, this 6061 billet Dual intake manifold incorporates a "tipped or directional" reed design without the need of a spacer plate. What this results in is a boost in overall hp without a significant loss in low speed performance. Hardware included to fit 62T cases.

Yamaha	Part No.
DASA Billet Dual Intake Manifold Kit V-2 Design	IN-7002
DASA Billet Dual Intake Manifold Kit V-3 Design	IN-7006



WATCON 550 INTAKE MANIFOLD SPACER

This Watcon intake spacer will allow the proper clearance for the SBN 44/46mm carb to be installed on a JS440/550 stock intake manifold. ****Gaskets and Hardware not included.**

Kawasaki	Part No.
Watcon Intake Manifold Spacer	K550-SPCR
Intake Manifold Gasket	5250



HOT PRODUCTS SEA-DOO 580/650/720 DUAL INTAKE MANIFOLD

Works for both parallel and inline Mikuni carb applications.

Sea-Doo	Part No.
580/650/720	53-0923



R&D SEA-DOO 800 DUAL INTAKE MANIFOLD

For use with Mikuni 44/46 and Keihin 38/40/42 carburetors.

Sea-Doo	Part No.
XP800	223-80000



WATERCRAFT WERKS SEA-DOO 951 DUAL MANIFOLD

Fits Mikuni Performance 44 and 46mm carbs, OEM Sea-Doo carbs do not fit. Parallel carb orientation. Pre-drilled and tapped for 2 pulse fittings. Mounting hardware is included.

Sea-Doo	Part No.
951	WCW-951BILMAN

TRIPLE INTAKE MANIFOLDS FOR MIKUNI CARBURETORS

KOMMANDER KAWASAKI 1100/1200 INTAKE MANIFOLD

The Kommander Kawasaki 1100 Triple intake manifold features a speed plate for easier removal of the carbs. Designed to fit all 44mm thru 49mm Mikuni carbs. Supplied with all required hardware and gaskets.

Kawasaki	Part No.
Kommander Kaw 1100/1200 Intake Manifold	KOM-107-SP
Replacement O-Ring (Sold Individually)	KOM-HWN70-226

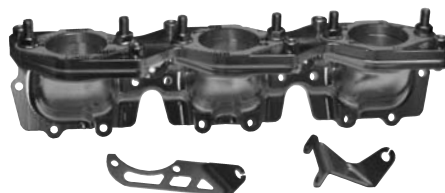

DASA 1100/1200 BILLET INTAKE MANIFOLD

Dasa's billet intake manifold for Mikuni 44mm to 50mm carbs, featuring a carb speed plate and developed for V-Force 3 reed applications (V3150-794-3). Supplied with all required hardware, gaskets and both a pump and diaphragm throttle cable bracket.

Description	Part No.
DASA 1100/1200 Billet Intake Manifold V-3 Design	KA-1101
Replacement O-Ring (Sold Individually)	137V



R&D YAMAHA 1100 TRIPLE INTAKE MANIFOLD

Fits all 1100 Triple motors. Designed to fit all 44mm and 46mm Mikuni carbs. Supplied with all required hardware and gaskets.

Yamaha	Part No.
R&D 1100/1200 (63M/65U) Intake Manifold	232-11000

R&D STXR 1200/ULTRA 150 SPIGOT MOUNT BILLET INTAKE KIT

For Mikuni SBN 44, 46 or 48mm Spigot Mount (M-VM40-200K) Carb Applications. See page 106.

Kawasaki	Part No.
Ultra 150/STX-R Kit	231-15000

*Use with M-16 reed only





Carbon Tech



Carbon Tech Reed Kits are sold as a complete kit for each motor application.
Each part will allow you to upgrade the reeds in each engine.

Sea Doo

CC	Model	Year	Performance Info	Part No.
951	All 951 models	97-06	Better mid & topend for stock, limited and superstock motors: +4hp midrange,+2 top 206HT Highly modified motors for topend only	206SS or 206HT

Yamaha

CC	Model	Year	Performance Info	Part No.
650	All 650 models	89-96	Smoother powerband	223LT
701	Wave blaster	93-95	225LT Stock cylinder, single carb.	225LT
with	Superjet	94-95		
61X	FXI	94-95		
CASE	PROVXR	93-94	225M Ported motors, single carb. 225SS Ported motors, dual carbs	or 225M 225SS
	Waverunner III	94-95,97		
	Waveraider	96-97		
701	Waveraider	94-95	202LT +3HP in midrange: for limited and stock motors	202LT
with	Waveblaster	96		
62T	Superjet	96-09		
CASE	Wave Venture	95-98		
	XL 700	99-04		
760	All 760 Models	96-00	202LT +3 HP in mid, +2HP top end for limited and non-ported rec boats	202LT
800	GP800	98-00	Better midrange & topend for stock	266HT
	GP800R	01-05	Limited & superstock motors: Gives 100 RPM=1 MPH	
	XL/XLT 800	00-04	(tested by Pro-Tec)	
1100	All 1100 models	95-97	Better midrange	302LT
1131	GP1200	97-99	*+3 HP mid to top: limited racing	338LT
	XL1200	98-99	Top end: only choice for fuel lng.	
	SUV1200	99-04		
1176	XL1200Ltd	99-00	Stock motors, single pipe motors	366HT
	XLT1200	01-05	Single pipe, limited triple pipe	
	GP1200R	00-02		
1296	GP1300R	03-08	Stock motors, single pipe motors	366HT
			Single pipe, limited triple pipe	366SS

Kawasaki

CC	Model	Year	Performance Info	Part No.
550	ALL 550	91-95	Smoother powerband	239LT
650	ALL 650	86-96	Improved low to midrange	212LT
743	ALL 750	92-02	Better low & mid: stock & limiteds	238LT
			Superstock & ported motors	238SS
			High RPM, stroked or fuel injected	238HT
782	800 Motor	03-09	Better low & mid: stock & limiteds	238LT
			Superstock & ported motors	238SS
			High RPM stroked or fuel injected	238HT
			Better midrange and bottom end	338LT
891	ALL 900 MOTORS	95-06	Better midrange and bottom end	338LT
1071	ALL 1100 MOTORS	96-04	Better low & mid: stock & limiteds	338LT
			High RPM, stroked or fuel injected	338HT
1176	Ultra 150 1200STXR	99-05		338LT
		04-05		338HT



CTMT2P127-1

CARBON TECH REED FOR V-FORCE 3

Carbon Tech V-Force 3 Reed Pedal Kits are sold per reed block, one part per block.

Description	Part No.
Carbon Tech Reed for V-Force 3	CTMT3P794A
Carbon Tech Reed for V-Force 2	CTMT2P127-1



BOYESEN POWER REEDS

- The unique dual-petal design
- Quicker acceleration, throttle response and speed.
- Dual-flex epoxy fiber material for maximum longevity and reliability.

Boyesen Reed Kits are sold as a complete kit for each motor application. Each part will allow you to upgrade the reeds in each engine.

Yamaha	Part No.
500 All	BY022
650 Super Jet	BY023
650 Wave Runner (All)	BY023
701 Wave Raider (All)	BY024
701 FX1 (94-95)	BY024
701 Pro-VXR (93-94)	BY024
701 Super Jet (94-95)	BY024
Wave Blaster (93-95)	BY024
Wave Raider (Single Carb) (96)	BY024
Wave Runner III (94-97)	BY024
701 Super Jet (96-12)	BY026
Wave Blaster (96)	BY026
Wave Raider (94-96)	BY026
Wave Raider DLX (95-96)	BY026
Wave Runner XL (99-04)	BY026
Wave Venture (95-98)	BY026
GP760(97-00), 760 Waves All (95-99)	BY029
1100 All (95-97)	BY028
GP1200(97-99), SUV1200(99-04)	BY033
XL1200(98)	BY033

Kawasaki	Part No.
550SX (91-95)	BY014
650SX/X2/SC/SS/ST/TS (All)	BY012
750SX/SXI/SXI-Pro (All)	BY013
750SS/STS/XI/ZXI (All)	BY013
800 SX-R (03-12)	BY013
900ZXI (-97), STX (97-01), STS (01)	BY020
1100ZXI/STX (96-03)	BY021
Ultra 130 (01-04)	BY036
STX-R 1200 (02-05), Ultra 150 (99-05)	BY021

Polaris	Part No.
650 All (92-95)	BY016
SL750 (93-95), SLT750 (94-95)	BY016
SL780 (96-97), SLT780 (96-97)	BY016
SLT780 (96-97), SLX780 (96)	BY016
SLX785 Pro (97-01)	BY016
700 All (-02)	BY013
Octane (02-04)	BY013
800 DI (02-04)	BY013
Hurricane (96-97)	BY013



BOYESEN PRO SERIES REEDS

- Quicker acceleration for that all important holeshot.
- Crisper mid-range allowing you to pull that extra boat length.
- Carries RPMs further past peak allowing you to run that steeper pitched impeller for increased top end.

- Easy starting and smoother idling for those dreaded no-wake zones.
- Increased life over traditional carbon fiber reeds.

Boyesen Reed Kits are sold as a complete kit for each motor application. Each part will allow you to upgrade the reeds in each engine.

Yamaha	Stock/Limited	Hi-Performance
700 Wave Raider (All)	—	PRO-35
701 FX1 (94-95)	—	PRO-35
701 Pro-VXR (93-94)	—	PRO-35
701 Super Jet (94-95)	—	PRO-35
701 Super Jet (96-12)	PRO-36	PRO-37
Wave Blaster (93-95)	PRO-36	PRO-37
Wave Blaster (96)	PRO-36	PRO-37
Wave Raider (94-96)	PRO-36	PRO-37
Wave Raider, Single Carb (96)	—	PRO-35
Wave Raider DLX (95-96)	PRO-36	PRO-37
Wave Runner III (94-97)	—	PRO-35
Wave Runner XL (99-04)	PRO-36	PRO-37
Wave Venture (95-98)	PRO-36	PRO-37
GP760 (97-00)	PRO-38	PRO-39
760 Waves All (96-99)	PRO-38	PRO-39
1100 All (95-97)	PRO-40	—
GP1200 (97-99), GP1200R (99)	PRO-77	PRO-78
SUV1200 (99-04), XL1200 (98)	PRO-77	PRO-78

Kawasaki	Stock/Limited	Hi-Performance
750 All	PRO-24	PRO-25
800 SX-R (03-12)	PRO-24	PRO-25
900 All (-96)	PRO-76	—
1100 All (96-03)	PRO-57	—
Ultra 150/STX-R1200 (99-05)	PRO-57	—

Polaris	Stock/Limited	Hi-Performance
700 All (thru 04)	PRO-26	PRO-27
Octane (02-04)	PRO-26	PRO-27
750 All (93-95)	—	PRO-29
780 All (98-97)	—	PRO-31
785 SLX Pro (97-01)	—	PRO-31



BOYESEN REED VALVE STUFFER KIT



- Precision cast aluminum stuffers assure no warping or misalignments
- Carbon fiber Pro Series reeds for unrivaled performance
- Improved intake efficiency providing a broader, smoother powerband
- Easy-to-install, requires no modification

The Boyesen Reed stuffer includes: 3 PRO-128 Reed Kits and 3 Boyesen Reed Stuffers includes a complete engine set of Boyesen 3D Reed Valve Stuffers and Boyesen PRO Series reeds.

Yamaha	Part No.
Reed Valve Stuffer Kit GP1200R (00-02), XL/XLT 1200 (99-05), GP1300R (03-08)	RSK-306
Replacement Reed Must use with Boyesen Stuffer	PRO-128
*PRO-128 is sold per reed block (3 required for a complete engine)	

FOUR STROKE
INTAKE SYSTEMS
ENGINE/GASKETS
EXHAUST
DRIVE LINE HANDLING
ELECTRICAL
WATERLINE /BILGE
STEERING & CONTROLS
BODY
ACCESSORIES SERVICE TOOLS
/HARDWARE
CHEMICAL

VFORCE3

BY MOTO TASSINARI

MOTO TASSINARI VFORCE3



Yamaha	VForce 3	Repl. VForce 3 Pedal	Repl. VForce 3 Gasket
All Yam Triples*	V3140-794-3	3P794A	G3140**
All Yam Twins*	V3140-794-2	3P794A	G3140**

*Not compatible for older WaveBlasters and GPR (Power valve cylinders) applications.
**Gaskets are sold individually.

Kawasaki	VForce 3	Repl. VForce 3 Pedal	Repl. VForce 3 Gasket
All Kaw Triples	V3150-794-3	3P794A	G3150**
All Kaw Twins	V3150-794-2	3P794A	G3150**

**Gaskets are sold individually.

Polaris	VForce 3	Repl. VForce 3 Pedal	Repl. VForce 3 Gasket
Octane 777	V3130-794A-2	3P794A	—

**Gaskets are sold individually.

VFORCE DELTA 2

Moto Tassinari

VFORCE DELTA 2



• Sold as complete kit per engine.

Sea-Doo	VForce Delta 2	Delta 2 Repl. Pedal	Delta 1 Repl. Pedal (97-99)	Repl. Gasket
GSX/GTX/XP 951	Discontinued	2P127-1	DP120-1	6755**

Polaris	VForce Delta 2	Delta 2 Repl. Pedal	Delta 1 Repl. Pedal (97-99)	Repl. Gasket
SL650, SL/SLT750	V2W131-3	2P117-1	-----	4050**
SLX780/785 Pro				
SL900/SLTX1050	V2W132-3	2P117-1	-----	4050**

Yamaha	VForce Delta 2	Delta 2 Repl. Pedal	Delta 1 Repl. Pedal (97-99)	Repl. Gasket
All Yamaha Triples	V2W140-3	2P127-1	DP120-1	4430**
All Yamaha Twins***	V2W140-2	2P127-1	DP120-1	2830**

***Except older Blasters

Kawasaki	VForce Delta 2	Delta 2 Repl. Pedal	Delta 1 Repl. Pedal (97-99)	Repl. Gasket
All Kawasaki Triples	Discontinued	2P127-1	DP120-1	G140-2**
All Kawasaki Twins	Discontinued	2P127-1	DP120-1	G140-3**

**Gaskets are sold individually.

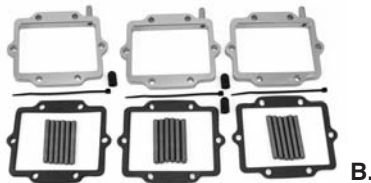

KAWASAKI ADA RACING ANGLED REED SPACER KIT

The ADA Racing Reed Spacer Kit features a 3 degree angle for Kawasaki engines. The kit includes billet aluminum spacers, gaskets, studs and additional pulse fittings.

Kawasaki	Part No.
A. Kawasaki 750/800 Angled Reed Spacer Kit	31-130390
B. Kawasaki 900/1100 Angled Reed Spacer Kit	31-131390



*Hardware and gaskets not included.

KAWASAKI R&D REED VALVE SPACERS

Kawasaki	Part No.
750/800 Reed Spacer Set*	251-75010
750/800 Reed Spacer Angled Set*	251-80000
Reed Gasket (sold individually)	7050

*Hardware not included.

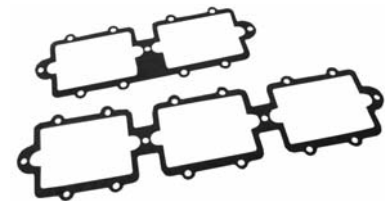

YAMAHA R&D REED VALVE SPACERS

These Reed Spacer Kit features a 3 degree angle for Yamaha engines. The kit includes billet aluminum spacers, gaskets and studs.

Yamaha	Part No.
701/760 (62T/64X) Reed Spacer Angled	262-70101
701/760 Spacer Gasket	53-5235-GSK
1100/1200 Spacer Gasket	53-5236-GSK

ROTARY VALVE PARTS

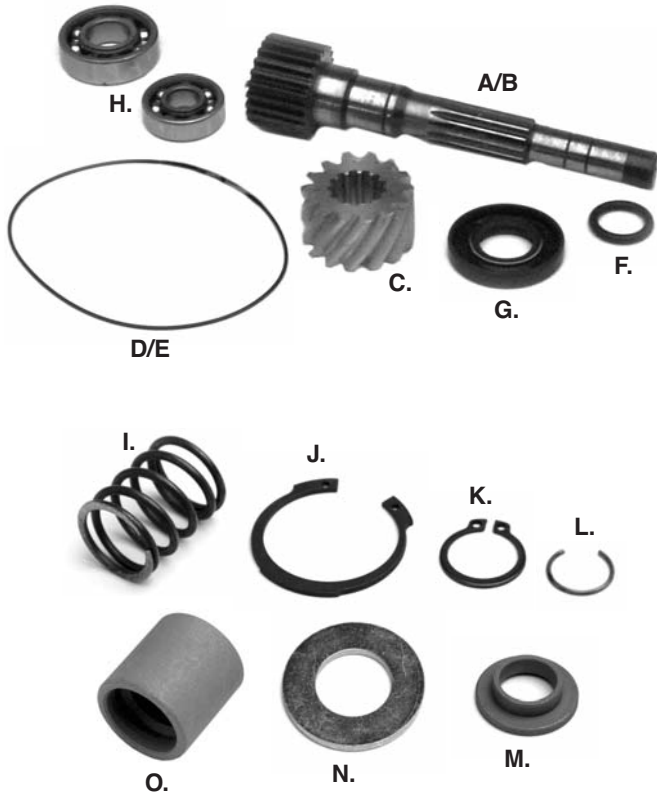

ROTARY VALVE TIMING WHEEL

Sea Doo	Part No.
Hot Products Rotary Valve Timing Wheel	012-170



ROTARY SHAFT PULLER

Special rotary shaft puller tool for Sea-Doo PWC.
Fits: Most 580cc, 650cc, 720cc, and 800cc Sea-Doo engines.
(6mm thru bolt included)
**Lubrication of all areas is required before using this tool*

Sea Doo	Part No.
Rotary Shaft Puller	B-204

SEA-DOO ROTARY VALVE SHAFT AND PARTS

Descriptions	OEM#	Part No.
A. Rotary Valve Shaft 580/650/720	293-837-251	010-455
B. Rotary Valve Shaft 800	290-837-351	010-457
C. Rotary Valve Shaft Gear only (14 teeth) 580/650/720/800 (89-up)	420-935-735	010-450
D. Rotary Cover O-Ring 580/650/720	293-300-023	6250
E. Rotary Cover Manifold O-Ring 800	290-831-765	6628
F. Rotary Shaft O-Ring 580/650/720/800	293-300-024	6260
G. Rotary Shaft Oil Seal 580/650/720/800	290-930-580	009-779
H. Rotary Shaft Bearing 580/650/720/800	290-932-032 290-932-797	010-225 010-226

Descriptions	OEM#	Part No.
I. Rotary Shaft Spring 580/650/720/800	290-938-810	010-453
J. Rotary Shaft Snap Ring - Large 580/650/720/800	290-845-260	010-483
K. Rotary Shaft Snap Ring - Small 580/650/720/800	290-932-032	010-482
L. Rotary Shaft C-Clips 580/650/720/800	290-845-160	010-454
M. Rotary Spring Holder 580/650/720/800	420-827-430	010-484-01
N. Rotary Bearing Washer 580/650/720/800	420-227-439	010-459
O. Rotary Shaft Barrel 580/650/720/800	290-847-282	010-484



STAINLESS STEEL ROTARY VALVES

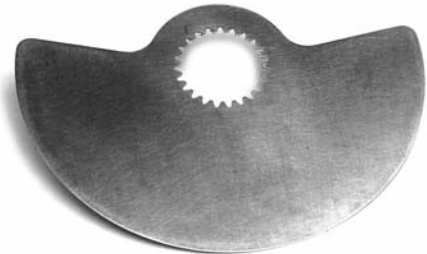

Model	Year	Opening Duration	Part No.
580 All	94-96	147°	006-147
650 All	94-95	159°	006-159
720	95-02	159°	006-159
785	95-02	159°	006-159



SEA-DOO ROTARY VALVE ASSEMBLY

Description	Part No.
580 All, 650 All, 720 All	010-455K
800 All	010-457K

FOUR STROKE
INTAKE SYSTEMS
ENGINE/GASKETS
EXHAUST
DRIVE LINE HANDLING
ELECTRICAL
WATERLINE /BILGE
STEERING & CONTROLS
BODY
ACCESSORIES
SERVICE TOOLS /HARDWARE
CHEMICAL



A.

NEW

B.

ONE WAY CHECK VALVE

One way vent valve allows air to travel in one direction only. 1/4" Fuel Line.

Description	Color	Part No.
A. One Way Check Valve 1/4" Hose Barb	Blk/Wht	CV-14B
B. One Way Check Valve 1/4" Hose Barb	Black	53-9940



Billet aluminum fuel pickup with brass hose fittings. Can be used on dual and triple carb setups with a supply line for each carb. This has up to 3 supply lines, 1 return, and 1 vent. Please note this does not include the fuel lines or the in-tank filters necessary.

Description	Part No.
Billet Fuel Pickup Silver	31-452090
Billet Fuel Pickup Black	31-452000

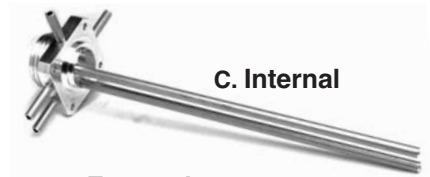

C. Internal

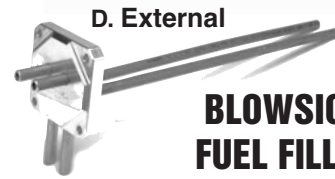

D. External

BLOWSION FUEL FILLER FOR KAWASAKI SX/SXI/SXI-PRO/SX-R

Description	Part No.
C. Billet Dual Internal Fuel Filler	01-02-506
D. Billet Dual External Fuel Filler	01-02-507



HOT PRODUCTS FUEL PICKUP FOR KAWASAKI 1100 SXR CONVERSION & ZXI/STX-R

Provides maximum fuel flow to triple carbs applications. Used by the top Professional Racers for conversion Race Ski applications.

Description	Part No.
Silver	53-9957
Black	53-9958

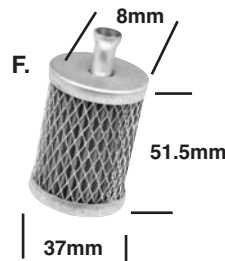

F.

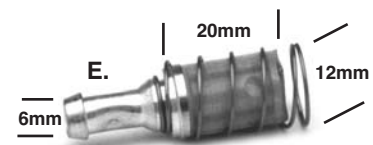

E.



G.

FUEL TANK FILTER

Description	Part No.
E. Universal Fuel Tank Filter (Replaces Sea-Doo #275-500-005)	53-9946
F. Universal Fuel Tank Filter (Replaces Yamaha #8H5-224560-00)	006-516
G. Sea-Doo Fuel Filter Tank Filter (Replaces Sea-Doo #275-500-089)	006-510



BLOWSION YAMAHA FUEL PICKUP INTERNAL FILLER

Designed with the option for use as a single, dual and triple pickup this billet beauty is the lowest profile and lightest weight internal fuel filler available. Features include heavy duty O-ringed tank and fuel cap seals, machined aluminum fuel pickup tubes for retrieving fuel under the most insane water action. Pickup tubes can also be trimmed and used for reserve line, return line or tank vent, depending on carburetor setup and fuel demands needed. Each filler includes block off plugs for single carbs or OEM Yamaha carbs as well as a BlowSION front rubber tank block off.

Description	Part No.
Black	01-02-494
Clear (Silver)	01-02-495
Red	01-02-496
Blue	01-02-497
Green	01-02-498
Orange	01-02-499



HOT PRODUCTS IN-LINE OIL FILTER

60 Micron Stainless Steel Element. 1.3" diameter, 1/4" Fuel Line. This filter works with fuel and oils. Perfect protection for oil pumps and oil injection engines.

Filters are E85 (Ethanol) fuel safe.

Description	Part No.
Stainless Steel Filter	53-9943
Retail Sales Display Card with 20 Filters	53-9943D



3" SLIMLINE FUEL FILTER WITH POLYESTER ELEMENT

Lightweight high flow 125 Micron Polyester Element. 3" length. 1/4" Fuel Line.

Filters are E85 (Ethanol) fuel safe.

Description	Part No.
3" Slimline with Polyester	53-9953
Retail Sales Display Card with 20 Filters	53-9953D



2" SLIMLINE FUEL FILTER WITH BRONZE ELEMENT

Clear nylon housing and bronze element. 40-70 Micron (2" length) - Part #53-9952

Filters are E85 (Ethanol) fuel safe.

Description	Part No.
2" Length Slimline with Bronze	53-9952
Retail Sales Display Card with 20 of the 2" Slimline	53-9952D



MULTI FREERIDE WORLD CHAMPION, PIERRE MAIXENT. PHOTO COURTESY OF LUDOVIC MOUVEAU, FULLGAZ, S.A.R.L.



HIGH-CAPACITY HIGH FLOW FUEL FILTER

80 Micron Paper Element. 1.6" diameter, 1/4" Fuel Line.

Filters are E85 (Ethanol) fuel safe.

Description	Part No.
High Flow Paper Filter	53-9945
Retail Sales Display Card with 20 Filters	53-9945D



RIVA OE REPLACEMENT FUEL FILTERS

OE replacements fit stock mounting bracket in all Yamaha watercraft these fuel filters also serve as a water separator protecting the motor from water damage.

Description	Part No.
OE Replacement Filter (all except 66V/E)	RY-0501
OE Replacement Filter 66V/E	RY-0502



TI-5-BFF-NATURAL



TI-5-BFF-BLACK



5GALFTANK-NATURAL

THRUST INNOVATIONS 5 GALLON GAS TANK

The first and only 5 gallon fuel tank to fit all stand up model watercraft equipped with Power Factor Exhaust. Designed with Crosslink Technology material, this gas tank will last a life time. The tank includes gas cap, filler neck, 2 pick ups, 1 return and 1 vent fitting. Tanks are available in: Red, Black and Natural.

Description	Color	Part No.
Standard Gas Tank	Black	5GALFTANK-BLK
Standard Gas Tank	Red	5GALFTANK-RED
Standard Gas Tank	Natural	5GALFTANK-NATURAL
Billet Filler Gas Tank	Natural/Black Filler	TI-5-BFF-NATURAL
Billet Filler Gas Tank	Black/Silver Filler	TI-5-BFF-BLACK

FOUR STROKE
INTAKE SYSTEMS
ENGINE/GASKETS
EXHAUST
DRIVE LINE HANDLING
ELECTRICAL
WATERLINE /BILGE
STEERING & CONTROLS
BODY
SERVICE TOOLS ACCESSORIES
CHEMICAL



UNIVERSAL FUEL VALVE 90 DEGREE

- Universal design fits most machines
- Comes complete with fuel knob
- 3 positions: on/off/reverse
- Inexpensive way to replace old, discontinued OEM valves
- 1/4" Hose 90 degree

Description	Part No.
Universal Fuel Valve (90 degree) 3 Positions	006-600



UNIVERSAL FUEL VALVE STRAIGHT

- Universal design fits most machines
- Comes complete with fuel knob
- 3 positions: on/off/reverse
- Inexpensive way to replace old, discontinued OEM valves
- 1/4" Hose Straight

Description	Part No.
Universal Fuel Valve Straight 3 Positions	006-602

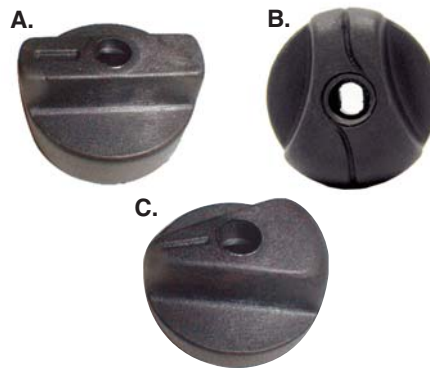

FUEL VALVE KNOB

Description	Part No.
A. Sea-Doo Early Style OEM #275000134	006-610
B. Sea-Doo Late Style OEM #275500263	006-611
C. Yamaha OEM #6K8-24524-10	006-612



QUICK DISCONNECT RESTRICTOR

Mikuni main jets thread into the billet part of the restrictor. This kit is used on the return lines of carburetors to fine tune fuel pump pressures.

Description	Part No.
Quick Disconnect Restrictor 1/4"	QD-14



Recommended Main Jets:

Stock Carbs for 1200 (66V) 105
Novi Carbs for 1200 (66V) 100-120
Novi Carbs for 701 (61X) 100-120

RIVA FUEL RETURN LINE RESTRICTOR 1/4" LINE

Designed to improve throttle response and reduce lean conditions in power band, the RIVA Fuel Return Line Restrictor installs into fuel return line between carburetors and fuel tank, restricting fuel return rate, increasing pressure to carburetors. Precision-machined billet restrictor is threaded to accept a Mikuni Main Jet (not included) to match your application. For use with OEM and aftermarket carburetors.

Description	Part No.
Fuel Return Line Restrictor	RY12-RLR-14



SEA-DOO 951DI FUEL PUMP KIT

OEM #275500502, #275500641, #275500655, #204250212, #275500540, #275500585, #204560289, #275500432, #275500622

Fits: LE DI (2004-05), 3D DI (2006-07), GTX DI (2000-03), LRV DI (2002), RX DI (2000-02), XP DI (2003-04)

Description	Part No.
Sea-Doo 951 DI Fuel Pump Kit	004-805



2015 RUNABOUT OVERALL CHAMPION JEAN BRUNO PASTORELLO & JEAN-BATISTE BOTTI CELEBRATING WITH AWARD, FACTORY ZERO JET BUNK TOTE, AT THE AWARD CEREMONY OF THE 2015 HOT PRODUCTS IJSBA MARK HAHN MEMORIAL HAVASU 300 ENDURANCE RACE IN LAKE HAVASU CITY, ARIZONA.

HOT PRODUCTS PRIMER KITS

53-9920
Single Mikuni
Plunger
Primer Kit
Shown



53-9101
Single Mikuni
Bulb Primer
Kit Shown



NEW

A cure for hard-starting motors. Draws fuel from the fuel line to give the carburetor a blast of fuel for easy starting. Eliminates chokes and adds to battery life. A must on high-performance modified carburetors with eliminated chokes. Hot Products primers are assembled with top-quality materials and include 9 feet of 1/8" blue primer hose to fit sit down craft. USA made top-quality plunger, brass "T" fittings, spigot, caps and zip ties.

Plunger Primer Kit		Part No.
Mikuni Primer Kit	Single	53-9920
Mikuni Primer Kit	Dual	53-9928
Mikuni Primer Kit	Triple	53-9922
Keihin Primer Kit	Single	53-9925
Keihin Primer Kit	Dual	53-9929
Keihin Primer Kit	Triple	53-9924

Bulb Primer Kit		Part No.
Mikuni Primer Kit	Single	53-9101
Mikuni Primer Kit	Dual	53-9102

*Hot Products Bulb Primer Kits use the same parts primer kit specifications listed below except for the bulb primer replacing the plunger.

HOT PRODUCTS "PLUNGER" PRIMER KIT BREAKDOWN BY PART NUMBER AND QUANTITY PER ITEM

Primer Kit Part No.	Item Description Item Part No.	Plunger Primer 53-9910A	Primer Line 53-9980	1/4x1/4x1/8 "T" 64-0017	1/8x1/8x1/8 "T" 64-0015	Mikuni Fittings 53-9921	Keihin Fittings 53-9926	Zip Ties See Pg. 294
53-9920	MIKUNI SINGLE	1	9FT	1	0	1	0	3
53-9928	MIKUNI DUAL	1	9FT	1	1	2	0	6
53-9922	MIKUNI TRIPLE	1	9FT	1	2	3	0	6
53-9925	KEIHIN SINGLE	1	9FT	1	0	0	1	3
53-9929	KEIHIN DUAL	1	9FT	1	1	0	2	6
53-9924	KEIHIN TRIPLE	1	9FT	1	2	0	3	6

HOT PRODUCTS PRIMER KIT REPAIR PARTS



53-9910A
Plunger Primer



53-9915
Button Primer

Primer Kit Parts Only	Part No.
Plunger Primer Only	53-9910A
Button Primer Only	53-9915



Spigot & Plug Kits

Primer Kit Parts Only	Part No.
H. Mikuni Brass Spigot & Plug Kit	53-9921
Mikuni Brass Plug Only	53-9921B
I. Keihin Brass Spigot & Plug Kit	53-9926
Keihin Brass Plug Only	53-9926B
J. Brass T for Dual 1/8 x 1/8 x 1/8	64-0015
K. Brass T for Primer 1/4 x 1/4 x 1/8	64-0017
Brass T 1/4 x 1/4 x 1/4	64-0019
Primer Line 1/8" (Sold per foot) Color Blue	53-9980
L. Plastic T Fitting 1/4 x 1/4 x 1/8	64-0095

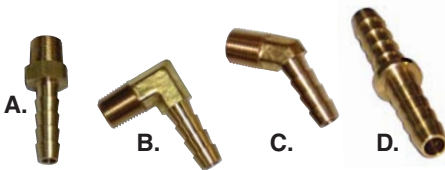

1/4" HOSE BRASS FITTINGS

Description	Part No.
A. Straight: 1/8" Thread 1/4" Hose	64-0001
B. 90 Deg: 1/8" Thread 1/4" Hose	64-0010
C. 45 Deg: 1/8" Thread 1/4" Hose	64-0065
D. Barb Connector 1/4" I.D.-1/4" I.D.	64-0057

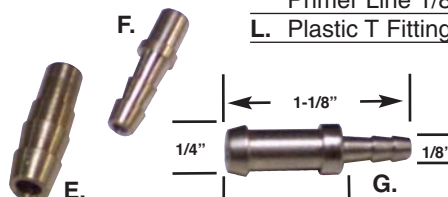

PRESS IN NIPPLE

Description	Part No.
E. 1/8" Straight	53-9936
F. 1/4" Straight	53-9937
G. Press-in Nipple 1/4"-1/8"	53-9935



PLASTIC "Y" FITTINGS

Description	Part No.
1/4" X 1/4" X 1/4" (White)	64-0046
1/4" X 1/4" X 1/4" (Black)*	64-0047

*Reinforced with Crossbar

FOUR STROKE
INTAKE SYSTEMS
ENGINE/GASKETS
EXHAUST
DRIVE LINE HANDLING
ELECTRICAL
WATERLINE /BILGE
STEERING & CONTROLS
BODY
ACCESSORIES
SERVICE TOOLS
HARDWARE
CHEMICAL



HOT PRODUCTS 1/4" FUEL LINE & 1/8" PRIMER LINE

Our fuel and primer line is made from a thick walled polyurethane tubing. Both the fuel and primer line are translucent lines. Sold per foot or 25 feet packages.

Description	Size (ID)	Length	Part No.
Blue Fuel Line	1/4" - Fuel	Per foot	53-9970
Blue Fuel Line	1/4" - Fuel	25 feet	53-9970-25
Red Fuel Line	1/4" - Fuel	Per foot	53-9972
Red Fuel Line	1/4" - Fuel	25 feet	53-9972-25
Green Fuel Line	1/4" - Fuel	Per foot	53-9974
Green Fuel Line	1/4" - Fuel	25 feet	53-9974-25
Blue Primer Line	1/8" - Primer	Per foot	53-9980
Blue Primer Line	1/8" - Primer	25 feet	53-9980-25

*Call for special pricing on full roles of these lines.

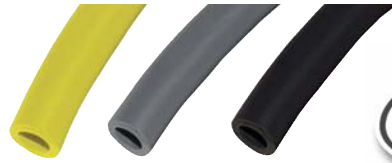

MOTION PRO PREMIUM FUEL LINE

Description	Part No.
Gray 1/4" ID x 25'	12-0032
Black 1/4" ID x 25'	12-0041
Yellow 1/4" ID x 25'	12-0068*
Black 5/16" ID x 25'	12-0042**

Great for all 2 stroke 5/16" fuel line applications, including the Mikuni DF62-702 dual fuel pump and PWC that use RY0502 Fuel filters
* P/N 12-0068 is considered a "Low Permeation" based fuel line designed to work in applications such as Ethanol based fuels for certain EPA emissions standards, etc.
**P/N 12-0042 is not for use on fuel injection applications.



HELIX HIGH PRESSURE TUBING

Helix High Pressure Tubing is a premium polyurethane, 85 durometer, which provides for superior abrasion, kink, tear, oxidation and chemical resistance. This tubing is very strong with a nylon inner band yet stays flexible.

1/4" ID x 3/8" OD Polyurethane, Nylon Interbraid

Description	Part No.
25 Foot HP Red Fuel Line	140-3125
25 Foot HP Yellow Fuel Line	140-3126
25 Foot HP Blue Fuel Line	140-3127
25 Foot HP Green Fuel Line	140-3128
25 Foot HP Clear Fuel Line	140-3129

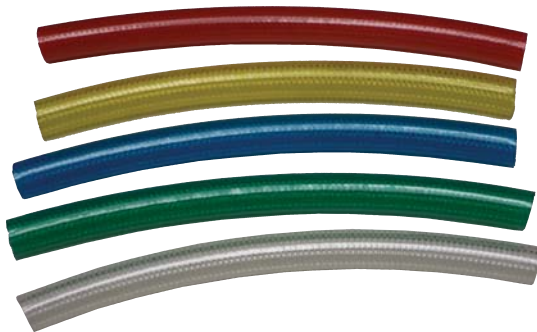

3/8" ID x 9/16" OD Polyurethane, Nylon Interbraid
Color Matched Water Line

Description	Part No.
25 Foot HP Red Water Line	380-9175
25 Foot HP Yellow Water Line	380-9176
25 Foot HP Blue Water Line	380-9177
25 Foot HP Green Water Line	380-9178
25 Foot HP Clear Water Line	380-9179



HELIX TRANSPARENT POLYURETHANE TUBING

Transparent Polyurethane. 3-500 ft. Helix® Fuel line is a premium polyurethane, 85 durometer, which provides for superior abrasion and kink, tear, oxidation and chemical resistance. Meeting temp 370f. Operating temp -75f to 155f. This fuel line will not get hard, stays flexible. **Not to be used with fuel containing more than 10% alcohol.**

*This Helix Translucent Polyurethane Tubing colors match the Helix High Pressure Tubing. Purple is not available in the High Pressure Tubing.

1/4" ID x 3/8" OD Transparent Polyurethane

Description	Part No.
25 Foot Red Fuel Line	140-3808
25 Foot Yellow Fuel Line	140-3809
25 Foot Green Fuel Line	140-3810
25 Foot Blue Fuel Line	140-3811
25 Foot Purple Fuel Line	140-3812
25 Foot Clear Fuel Line	140-3813



Fast, Easy, Strong and Secure Installation



**SQUEEZE ON STAINLESS STEEL
LOW PROFILE CLAMPS**

Oetiker Stepless Ear Clamps, due to the reinforcing 'dimple' in the ear, hold against pressure and vibration or hose shrinkage due to temperature changes. A built-in spring action permits the clamp to "breathe" without loosening, the need to retighten is eliminated. Once installed, any tampering is easily visible, making this an excellent clamp for service or security applications.

Description	Clamp Size mm	Part No.
Clamp for 1/4" Fuel Line Hose (10/pack)	11.3mm	59-4014
Clamp for 1/4" Fuel Injector Hose (10/pack)	14.5mm	59-4016
Clamp for 3/8" Water Line (10/pack)	17mm	59-4017
Clamp for 1/2" Water Line (10/pack)	21mm	59-4018

100 Clamp Packs	Clamp Size mm	Part No.
Clamp for 1/4" Fuel Line Hose (100/pack)	11.3mm	59-4014-100
Clamp for 1/4" Fuel Injector Hose (100/pack)	14.5mm	59-4016-100
Clamp for 3/8" Water Line (100/pack)	17mm	59-4017-100
Clamp for 1/2" Water Line (100/pack)	21mm	59-4018-100



Description Pincer Tool **Part No.** 12-0024



SIDE JAW PINCERS

When space is restricted, use side jaw pincers and hold it parallel.

Description Side Jaw Pincers **Part No.** 12-0073



**FUEL LINE Q/D W/SHUT-OFF VALVE
for 1/4" fuel line**

Description Fuel Line Q/D w/Shut-off Valve **Part No.** 53-9951



HOSE SHEARS

Simply Scissor-action cutter for hose. Cuts clean, straight and no damaged hose ends. A must have tool for every toolbox.

Description Hose Shears **Part No.** 12-0013

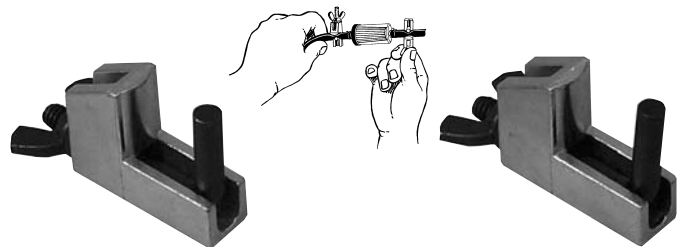

HOSE PINCHERS

Quick, easy way to pinch off fuel lines, etc, without damaging the fuel line. Sold two per set.

Description Hose Pinchers **Part No.** LS22850



**OETIKER
STAINLESS EAR
CLAMPS KIT**

Kit contains	Size	Quantity
Clamp for 1/4" Fuel Line Hose	11.3mm	10
Clamp for 1/4" Fuel Injector	14.5mm	10
Clamp for 3/8" Water Line	17mm	10
Clamp for 1/2" Water Line	21mm	10
Side Jaw Pincers		1

Description Oetiker Clamp Kit **Part No.** 59-4020

FOUR STROKE
INTAKE SYSTEMS
ENGINE/GASKETS
EXHAUST
DRIVE LINE HANDLING
ELECTRICAL
WATERLINE /BILGE
STEERING & CONTROLS
BODY
ACCESSORIES
SERVICE TOOLS /HARDWARE
CHEMICAL

HOT PRODUCTS ALUMINUM AIR FILTER ADAPTERS FOR MIKUNI CARBURETORS. SOLD INDIVIDUALLY.



Mikuni	Part No.
38mm 38mm Bore	53-4460
44mm 46mm Bore	53-4480
46mm 48mm Bore	53-4490

Adapter mounting hardware included



Mikuni	Part No.
OEM 40mm "I" Series (48mm Bore) Sea-Doo HX/XP, K750 SXI 96-02, K800SX-R 03-12	53-4465

Adapter mounting hardware included



Mikuni	Part No.
OEM Carb Yamaha GPR Series (57mm Bore)	34-120190

Adapter mounting hardware included



This new ADA Racing Billet aluminum carb adaptor has been developed for Yamaha 701 engines with dual Mikuni SBN 38mm carbs, these adaptors are taller than the standard adaptors so the air filters will not rub on the engine/head.

Mikuni	Part No.
Yamaha SJ 96+ 38mm	34-120290

Adapter mounting hardware included



25mm tall flame arrester riser. 48mm inner diameter. Can be used with the Yamaha Super Jet stock flame arrester box for head clearance on aftermarket heads. These are sold individually and does NOT include bolts.

Description	Part No.
Arrester Riser 25mm	30-121690



OIL INJECTION SPACER PLATES

Description	Part No.
Mikuni 44mm	53-4485
Mikuni 46mm	53-4495
Press in Nipple (1/8") only	53-9936

Spacer mounting hardware included

HOT PRODUCTS ALUMINUM AIR FILTER ADAPTERS FOR KEIHIN CARBURETORS

ALL ADAPTERS SOLD INDIVIDUALLY



Keihin	Part No.
38/40/42mm (50mm Bore)	53-4440

Keihin	Part No.
OEM Carb (44mm Bore) K750 SXI-95, 750ZXI, K900/1100ZXI	53-4450

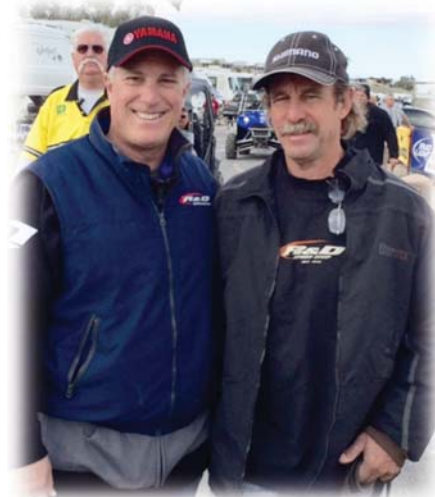

MIKE FOLLMER, PRODUCER OF THE 2015 HOT PRODUCTS IJSBA MARK HAHN MEMORIAL HAVASU 300 ENDURANCE RACE AND BILL CHAPIN, LIVING LEGEND MECHANIC AND PARTNER OF R&D RACING

Hot Products



HP 2 1/2" TORNADO SERIES FILTERS

Description	Filter Top Color	Part No.
Hot Products Tornado Filter 2 1/2"	Silver	53-4274-SIL
Hot Products Tornado Filter 2 1/2"	Black	53-4274-BLK
Hot Products Tornado Filter 2 1/2"	Blue	53-4274-BLU
Hot Products Tornado Filter 2 1/2"	Green	53-4274-GRN
Hot Products Tornado Filter 2 1/2"	Red	53-4274-RED
Outerwears Water Repellent Pre-Filter Clear Top		20-2761-01/HOTP



HP 2" TORNADO SERIES FILTERS

Description	Filter Top Color	Part No.
Hot Products Tornado Filter 2"	Silver	53-4273-SIL
Hot Products Tornado Filter 2"	Black	53-4273-BLK
Hot Products Tornado Filter 2"	Blue	53-4273-BLU
Hot Products Tornado Filter 2"	Green	53-4273-GRN
Hot Products Tornado Filter 2"	Red	53-4273-RED
Outerwears Water Repellent Pre-Filter Clear Top		20-2760-01/HOTP

HOT PRODUCTS TORNADO SERIES FILTERS

Manufactured by:



Hot Products Exclusive!

HP 2 1/2" TORNADO WHITE

Description	Filter Top Color	Part No.
Hot Products Tornado Filter 2 1/2"	White	53-4274-WHT



Metallic Paint!



TAU CETI LIMITED EDITION

Description	Filter Top Color	Part No.
Tau Ceti 2 1/2" Tornado Filter	Metallic Blue	53-4274-BLU-LE
Tau Ceti 2 1/2" Tornado Filter	Metallic Green	53-4274-GRN-LE
Tau Ceti 2 1/2" Tornado Filter	Metallic Red	53-4274-RED-LE



HP 1 1/2" TORNADO SERIES FILTERS

Description	Filter Top Color	Part No.
Hot Products Tornado Filter 1 1/2"	Silver	53-4271-SIL
Hot Products Tornado Filter 1 1/2"	Black	53-4271-BLK
Outerwears Water Repellent Pre-Filter Clear Top		20-2762-01/HOTP



OUTERWEARS WATER REPELLENT PRE-FILTERS

These new Outerwears Pre-Filters are specially designed for Hot Products Tornado Series Filters and feature a clear top, with black water repellent material.

Description	Part No.
Pre-Filter for 53-4274 2 1/2" Tall Filters	20-2761-01/HOTP
Pre-Filter for 53-4273 2" Tall Filters	20-2760-01/HOTP
Pre-Filter for 53-4271 1 1/2" Tall Filters	20-2762-01/HOTP



FLAME ARRESTORS (without Cotton Media)

Experience increased horsepower and engine protection with K&N Personal Watercraft flame arrestors for both normal and race applications.

Built for personal watercraft racing, these marine approved flame arrestors are designed to legally increase performance on your PWC.

Epoxy-coated aluminum wire mesh backfire screen resists corrosion.

Polished stainless steel top plates provide resistance to salt water.

Marine approved and meets US Coast Guard standards.

K&N flame arrestors replace the restrictive factory airbox. In most cases an filter adapter is required (for adapters see pages 105 & 131) to mount the flame arrestor onto the carburetor. Some watercraft may require a slight adjustment to the carburetor's fuel circuits to allow for optimum performance.

K&N "D-Shape"

Filters feature a "D" shape filter to allow the proper filter clearance to prevent damage to the filter

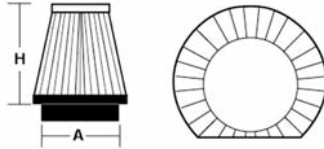

4" Tall (D-Shape)



59-2040R
STAINLESS TOP



59-2040RK
COMPOSITE TOP

Height	Top Color	Part No.
4"	Black Composite	59-2040RK
4"	Stainless Steel	59-2040R
Outerwears Water Repellent Pre-Filter		WR145-10-4DT

2-1/2" Tall (D-Shape)



59-2042R
CHROME TOP



59-2042RK
COMPOSITE TOP

Height	Top Color	Part No.
2-1/2"	Black Composite	59-2042RK
2-1/2"	Chrome	59-2042R
Outerwears Water Repellent Pre-Filter		WR145-115-25DT

Outerwears Racing Accessories

The Outerwears Pre-filter is an excellent solution to prevent water from entering into the engine without restricting air flow or causing a loss in performance. An Outerwears Pre-Filter is designed to be water repellent and will reduce the risk of water entering through an air intake system. Outerwears offers water repellent pre-filters for K&N, Tau Ceti, ProK and R&D performance air filters and flame arrestors.



Description	Flame Arrestor Type	Part No.
A. 4.25" x 3" Taper/4" Tall	K&N 59-2040R/RK	WR145-10-4DT
B. 4.25" x 3.5" Taper/2.5" Tall	K&N 59-2042R/RK	WR145-115-25DT
C. 4" dia/1.75" Tall	Tau Ceti (Round Style Filters) 53-4270	WR125-15DT
D. 4" dia/2.25" Tall	Tau Ceti (Round Style Filters) 53-4272. ProK	WR125-2DT
E. 4" dia/2.25" Tall (Open Top)	Tau Ceti (Round Style Filters) 53-4272, ProK	20-1275-01
F. 4" x 3" Taper/3.5" Tall	Tau Ceti (Round Style Filters) 53-4275	WR125-10-35DT
G. Pro-Lock SD951/2.5" Tall	R&D 203-95000	WR30-25DTPRO

2-3/4" Tall (Round)



Height	Top Color	Part No.
2-3/4"	Black Composite	59-2046
Water Repellent Pre-Filter		WR125-2DT



2015 QUAKYSENSE WORLD FINALS AMATEUR FREESTYLE CHAMPION TANNER THOMAS. PHOTO COURTESY OF JIN OMURA.

FOUR STROKE
INTAKE SYSTEMS
ENGINE/GASKETS
EXHAUST
DRIVE LINE HANDLING
ELECTRICAL
WATERLINE/BILGE
STEERING & CONTROLS
BODY
SERVICE TOOLS ACCESSORIES/HARDWARE
CHEMICAL



PERFORMANCE FILTER KITS FOR TWO STROKE MOTORS



Kawasaki **Part No.**
800SX-R Aftermarket Carb **200-00120**
120mm center to center
(Adapters not included)



Sea-Doo **Part No.**
951 All **203-95000**



Yamaha **Part No.**
GP1300R Stock Fuel **200-13143**
Injection
GP1200R/XLL/XLT1200 **200-00142**

PERFORMANCE FILTER KITS FOR FOUR STROKE MOTORS FOR ADDITIONAL 4-STROKE PRODUCTS SEE THE FOUR STROKE SECTION



R&D POWER PLENUM FLAME ARRESTER

The R&D High Flow Power Plenum replaces the restrictive stock flame arrester allowing more improved airflow, why? Because more air flow with less restriction means more power!

Yamaha **Part No.**
FX 140/Cruiser **200-00144**
FX HO/Cruiser



R&D HIGH FLOW POWER PLENUM AIR BREATHER

The R&D High flow breather is a direct replacement for the stock breather in the OEM air box. Water tested to deliver improved throttle response, acceleration and top speed with 50-100 RPM increase.

Yamaha **Part No.**
FX 140/Cruiser **200-00143**
FX HO/Cruiser



R&D VELOCITY STACK KIT

The R&D Velocity Stack Kit is a direct bolt-on kit that replaces the restrictive OEM stacks. Designed to increase air velocity into the throttle bodies producing improved throttle response and top end speed. Easily installs with OEM hardware.

Yamaha **Part No.**
FX 140/Cruiser **206-00140**
FX HO/Cruiser



R&D VX10 PERFORMANCE AIR FILTER KIT

The new R&D Performance Air Filter for the VX 110 is now available. The R&D High Flow Filter design replaces the restrictive stock filter inside the stock air box, allowing improved air flow.

Yamaha **Part No.**
VX110 **200-00110**
for Stock Carb Air Box

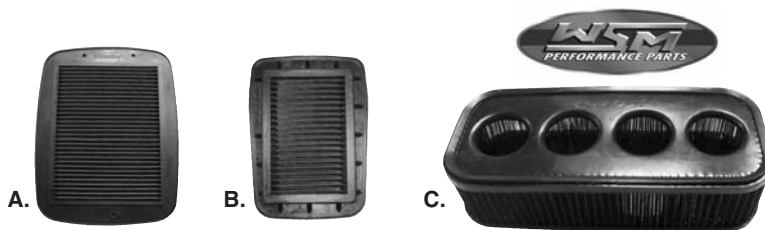

WSM WASHABLE AIR FILTERS FOR YAMAHA

Stock replacement air filters. Washable and reusable.

Yamaha	OEM#	Part No.
A. FX Cruiser HO (08-13), FX Cruiser SHO (08-13), FX HO (09-13), FX SHO (08-13), FZR/FZS (09-13), VXR/VXS (11-13)	6S5-E4451-00-00	006-590
B. VX (07-09), VX Cruiser (07-12), VX Deluxe (05-12), VX Sport (05-12)	6D3-14451-00-00	006-592
C. FX (05-08), FX140 (02-04), FX Cruiser (03-08) FX HO (04-08)	6B6-14451-00-00 6E-14451-00-00 6B-14451-01-00	006-594

AIR INTAKE & VENT SOLUTIONS



FZS 10003
3" OD x 2" ID
2 pc/kit



FZS 10025
2.5" OD x 1.5" ID • 3 pc/kit

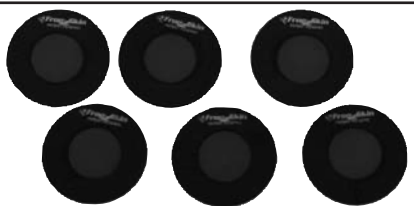

FZS 10015
1.5" OD x .75" ID • 6 pc/kit



FZSF3100
4" OD x 2.5" ID • 3 pc/kit



FZSF3101
4" OD x 3.5" ID • 4 pc/kit



FZSF3102
2.5" OD x 1.5" ID (x2) • 1.75" OD x 1" ID (x1)
4.5" OD x 3" ID (x2)

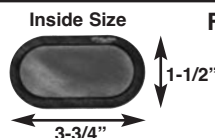

FZSF3103

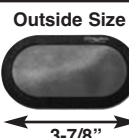

Frogskin Universal Kit	Part No.
Circle 3" OD x 2" ID (2 piece)	FZS10003
Circle 1.5" OD x .75" ID (6 piece)	FZS10015
Circle 2.5" OD x 1.5" ID (3 piece)	FZS10025

PWC Kit	Part No.
Kawasaki 800SXR (2003-13) (3 piece)	FZSF3100
Kawasaki Ultra 250X (2007-08), 260 X/LX (2009-10) & Ultra LX (2007-14) (4 piece)	FZSF3101
Yamaha SJ (1996+) (5 piece)	FZSF3102
Yamaha SJ (1996+) (2 piece) Rear Intake Vent Cover	FZSF3103



BILLET ALUMINUM OIL INJECTION BLOCK OFF KITS



Sea-Doo
580/650/720 All



Part No.
50-9504



Sea-Doo
800/951

Part No.
50-9506



Polaris
SL700/SLT700/Hurricane
SL900/SLTX/1050

Part No.
50-9509



Yamaha
650/701/760

Part No.
50-9500



Yamaha
1100/1200 GPR

Part No.
50-9501

Kawasaki
650/750

Part No.
50-9500

Kawasaki
900/1100

Part No.
50-9503

PLASTIC CAPS



The plastic caps have many uses on a PWC. Use the caps to cap the primer fittings, fuel fittings and any other item you need to cap will performing repairs or performing routine maintenance. Caps are sold in packs of 10.

Description	Part No.
Small 1/8" Cap - Oil Primer Nipple (10 pack)	50-9500P
Large 3/8" Cap - Carb/Fuel Nipple (10 pack)	50-9504P



KAWASAKI CASE DRAIN BLOCK OFF

Kawasaki	Part No.
650/750 Kawasaki Drain Case Block Off	50-9505

*Case Block Off not applicable for 800SX-R





WSM YAMAHA 800R/1200R CYLINDER KIT

OE replacement for new cylinder (no core exchange).
Kit includes new Nikosil cylinder, power valve and piston kit.
Fits: GP800R (2000-05), GP1200R (2000-02), XL800 (2001), XLT800 (2002-04), XLT 1200 (2001-05)

Description	Part No.
GPR Cylinder Kit	010-6029K





RHAAS ENGINE LOCK WASHER

These are extra thick washers for bolting your engine to the motor mount. They have teeth to dig in to the bedplate and prevent the engine from slipping. Made from 6061 aluminum and anodized to prevent corrosion. Sold individually in either bolt size, 8mm or 10mm.

Description	Part No.
8mm	ENGWASH-8MM
10mm	ENGWASH-10MM





BLOWSION ENGINE KEEPERS JOE KENNEY DESIGN

Kenney Keepers are a must have for any hardcore surf or flat-water invert artist. Each set contains a left and right side front mount retainer and extended stainless hardware for install. Blowsion's unique close tolerance design retains the front, "top heavy" weight of the engine block from being flexed or thrown forward during flat out and invert maneuvers. Since this is a common occurrence (even in flat water racing action), they have also been found to be excellent insurance against ever having to replace expensive engine mounts again.

Description	Color	Part No.
Yamaha SJ 96+	Blue	01-03-802
Yamaha SJ 96+	Black	01-03-803
Kawasaki 750SXI/800SXR	Green	01-03-801



AWARDS FOR THE 2015 IJSBA HOT PRODUCTS
MARK HAHN MEMORIAL HAVASU 300 ENDURANCE RACE
IN LAKE HAVASU CITY, ARIZONA.



ENGINE SHIMS

Engine shims are essential for precise engine alignment. R&D Engine Shims have a tab that provides easy insertion and removal. Shims are made of stainless steel and have etched numbers to identify thickness.

Description	Thickness	Part No.
Engine Shims	.010" (.254mm)	57-1900
Engine Shims	.020" (.508mm)	57-1902
Engine Shims	.050" (1.27mm)	57-1904
Engine Shims	.100" (2.565mm)	57-1906

FOUR STROKE
 INTAKE SYSTEMS
 ENGINE/GASKETS
 EXHAUST
 DRIVE LINE HANDLING
 ELECTRICAL
 WATERLINE /BILGE
 STEERING & CONTROLS
 BODY
 ACCESSORIES SERVICE TOOLS
 /HARDWARE
 CHEMICAL



A complete line of motor mounts designed specifically for heavy duty watercraft applications. Monkey Grip Motor Mounts are designed to be stronger than OEM mounts, yet able to dampen and isolate vibration far better than performance mounts currently available. This combination of durability and performance make Monkey Grip the right choice. Monkey Grip Motor Mounts are available for all popular watercraft.*



Part No. 57-1172

Yamaha Wave Blaster	93-96
Yamaha 701FX	94-95
Yamaha Wave Blaster II	96-97
Exciter	96-97
Exciter 220	98



Part No. 57-1162

Yamaha 650 Super Jet	All Years
Yamaha 701 Super Jet	All Years
RICKTER	All Models



Part No. 57-1152

Yamaha Wave Runner 500	All Years
Yamaha 650 VXR	91-95
Yamaha 650LX	91-92
Yamaha 650 Wave Runner III	90-96
Yamaha 701 VXR Pro	93-94
Yamaha 701 Wave Runner	93-00
Yamaha Wave Runner III GP	84-95
Yamaha Wave Raider 701	94-97
Yamaha Wave Runner III 701	97
Yamaha Wave Venture 701	95 & 98
Yamaha XL 701	99-04
Yamaha 760 GP	97-00
Yamaha 760 Wave Raider	96
Yamaha 760 XL	98-99
Yamaha 760 Wave Venture	97
Yamaha GP 800	98-99
Yamaha XL 800	00-03
Yamaha XLT 800	02-04
Yamaha Wave Raider 1100	95-96
Yamaha Wave Venture 1100	96-97
Yamaha GP 1200	97-99
Yamaha XL 1200	98
Yamaha 1200 SUV	99-04



Part No. 57-1174

Yamaha 1200 XL	99-01
Yamaha 1200 XLT	02-05
AR230	04-06
SR230	03-05
SX230	04-06



Part No. 57-1173

Yamaha 1200R GPR	00-01
Yamaha 1300 GP	04-08
Yamaha FX 140	02-06
Yamaha FX 1100	04-06
Yamaha VX 1100	05-09
Yamaha FX CRUISER	03-09



Part No. 57-1196

Polaris 650 SL	92-95
Polaris 750 SL	93-95
Polaris 780 SL	96-97
Polaris 780 SLT	96-97
Polaris 780 SLX	95-96
Polaris Virage	00-02



Tiger Shark

All Models 93-99,
640cc Engine

Part No. 57-1175



Part No. 57-1197

Polaris 700/900/1050	All
All SMC Hulls	Late Models

**Installation Warning-Alert! When changing the PWC motor mounts you must refer to the PWC Manufacturers Repair Manual for the proper installation instructions and the torque settings. If these instructions and torque setting are not followed properly damage may occur. Hot Products is not responsible for any damages incurred.*

**Part No. 57-1122***

Kawasaki 400/440/550/550SX	All
Kawasaki 750 XIR	94

**Part No. 57-1142***

Kawasaki 650	All
Kawasaki 750 (Except ZXI)	All
Kawasaki 800SX-R	03-12

**Part No. 57-1143***

Kawasaki 900 ZXI/STX/STS	All
Kawasaki 1100 ZXI/STX/STXDI	All
Kawasaki Ultra 150 Rear	All
Kawasaki STX 12F	All
Kawasaki STX-R Rear	All
Kawasaki STX 15-F	All
Kawasaki Ultra 250	All
Kawasaki Ultra 260	All
Kawasaki Ultra 300	All
Kawasaki Ultra LX	All

**Part No. 57-1144***

Kawasaki Ultra 150 Front	All
Kawasaki STX-R Front	All

**Part No. 57-1185*** (Front - 1 required)

Sea-Doo GTI LE RFI	03
Sea-Doo GTX RFI	98-02
Sea-Doo XP	00-02
Sea-Doo XP DI	03-04
Sea-Doo XP LTD	98-99

**Part No. 57-1183F*** (Front - 1 required)

Sea-Doo GSX	96-98
Sea-Doo GSX LTD	98
Sea-Doo GTX	96-97
Sea-Doo GTX LTD	98
Sea-Doo SPX	97-98
Sea-Doo XP	95-97

**Part No. 57-1182***

Sea-Doo 580/650/720	All*
---------------------	------

* Except 97 720SP

**Part No. 57-1188*** (Rear - 2 required)

Sea-Doo GTI 4-TEC	All
Sea-Doo GTX 4-TEC	All
Sea-Doo RXP 4-TEC	All
Sea-Doo RXT 4-TEC	All
Sea-Doo Wave 4-TEC	All

**Part No. 57-1183R*** (Rear - 2 required)

Sea-Doo GSX	96-98
Sea-Doo GSX LTD	98-99
Sea-Doo GSX RFI	99-00
Sea-Doo GTI LE RFI	03
Sea-Doo GTX	96-97
Sea-Doo GTX	00-02
Sea-Doo GTX DI	00-03
Sea-Doo GTX LTD	98-99
Sea-Doo GTX RFI	98-02
Sea-Doo LRV	00-02
Sea-Doo RX	00-02
Sea-Doo RX DI	00-03
Sea-Doo RXX	01
Sea-Doo SP	97
Sea-Doo SPX	97-99
Sea-Doo XP	96-97
Sea-Doo XP DI	03-04
Sea-Doo XP LTD	98-99

**Part No. 57-1186*** (Front - 1 required)

Sea-Doo GTI RFI	03-05
Sea-Doo 3D RFI	05-07

**Part No. 57-1187*** (Front - 1 required)

Sea-Doo GTI 4-TEC	All
Sea-Doo GTX 4-TEC	All
Sea-Doo RXP 4-TEC	All
Sea-Doo RXT 4-TEC	All
Sea-Doo Wave 4-TEC	All

FOUR STROKE	EXHAUST	ELECTRICAL	STEERING & CONTROLS	BODY	ACCESSORIES	SERVICE TOOLS / HARDWARE	CHEMICAL
SYSTEMS	DRIVE LINE HANDLING	WATERLINE /BILGE					
ENGINE/ GASKETS							
INTAKE							

All ADA Head Shells are available in these colors: Clear (Standard color - as shown), Green, Black, Blue, Red and Orange. Custom Logo laser printing is also available. Call for details.



ADA YA701M
Billet Girdle
Head Shell

ADA YA701L
Billet Non-Girdle
Head Shell



ADA YA701G6
Girdle
Hardware Kit

ADA YAMAHA 701/760 BILLET HEAD

Includes O-rings that fit into the grooves in the head shell, mounting hardware, and brass fittings. Clear anodized for protection against corrosion.

Yamaha	Part No.
Y701/760 Girdle Billet Head Shell	YA701M
(Girdle Hardware Kit is not included in Head Kit)	
Girdle Hardware Kit (6 pcs.) for Girdle Head	YA701G6
Y701/760 Non-Girdle Billet Head Shell	YA701L
701-81mm 29cc (230 lbs/115 Octane)	YA2129L
701-81mm 31cc (215 lbs/112 Octane)	YA2131L
701-81mm 33cc (200lbs/105 Octane)	YA2133L
701-81mm 34cc (192 lbs/95 Octane)	YA2134L
701-81mm 35cc (185lbs/92 Octane)	YA2135L
(35cc Dome for 100 Octane with Dry Pipe)	
701-81mm 37cc (170lbs/92 Octane)	YA2137L
760-84mm 29cc (245lbs/118 Octane)	YA7629L
760-84mm 31cc (230lbs/115 Octane)	YA7631L
760-84mm 33cc (215lbs/110 Octane)	YA7633L
760-84mm 35cc (200lbs/105 Octane)	YA7635L
760-84mm 36cc (193lbs/105 Octane)	YA7636L
760-84mm 37cc (187lbs/100 Octane)	YA7637L
760-84mm 38cc (180lbs/98 Octane)	YA7638L
760-84mm 40cc (165lbs/91 Octane)	YA7640L
760-84mm 42cc (150lbs/91 Octane)	YA7642L
Flat Top Dome – 22cc	YAK8622L15
4° w/.015" Relief@86mm	
Flat Top Dome – 24cc	YAK8624L15
4° w/.015" Relief@86mm	
Flat Top Dome – 26cc	YAK8626L15
4° w/.015" Relief@86mm	
Flat Top Dome – 28cc	YAK8628L15
4° w/.015" Relief@86mm	
Flat Top Dome – 30cc	YAK8630L15
4° w/.015" Relief@86mm	
Dome for Flat Top Kawasaki Piston @ 82mm 24cc	KD1224
Exhaust Pipe Mount Bracket	YEXBRKT-2M
O-Ring Kit	ORKIT-YA701M

*All ADA Domes are sold individually

ADA SUPER BORE HEAD

Yamaha	Part No.
Super Bore Non-Girdle Head Shell	YA760L-SB
Super Bore Girdle Head Shell	YA760M-SB
Super Bore 38cc Dome Yamaha - 89mm Bore	SD9538*

*All ADA Domes are sold individually

**ADA Super Bore Head Shells and Domes are Special Order Only.

***The ADA Super Bore Domes require the use of Sea-Doo pistons.



ADA YA1200R
Yamaha Billet Head
Shell Non-Girdle



ADA YAMAHA GP1200R

Includes o-rings that fit into the grooves in the head shell, mounting hardware, and brass fittings. Clear anodized for protection against corrosion.

Yamaha	Part No.
Billet Head Shell Non-Girdle	YA1200R
29cc (215-220Lbs/115 Octane)	YA8029
31cc (205-210Lbs/110 Octane)	YA8031
33cc (195-200Lbs/105 Octane)	YA8033
35cc (180-185Lbs/100 Octane)	YA8035
38cc (165-170Lbs/95 Octane)	YA8038
40cc (155-160Lbs/91 Octane)	YA8040
42cc (140-145Lbs/89 Octane)	YA8042

*All ADA Domes are sold individually

**ADA Yamaha GP1200R Head Shells and Domes are Special Order Only.

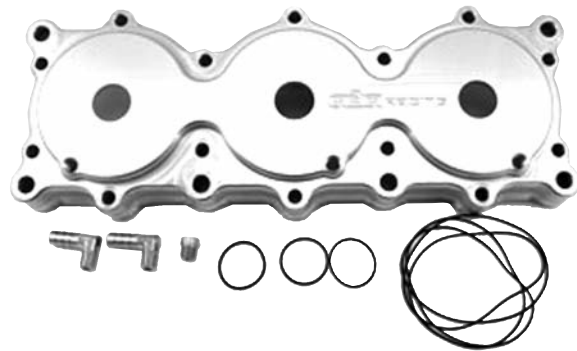

ADA YAMAHA 1100/GP1200

Includes O-rings that fit into the grooves in the head shell, mounting hardware, and brass fittings. Clear anodized for protection against corrosion.

Yamaha	Part No.
Girdle Billet Head Shell	YA1200M
Girdle Hardware Kit (6 pcs) for Girdle Head	YA701G6

Yamaha	Part No.
701-81mm 29cc (230 lbs/115 Octane)	YA2129L
701-81mm 31cc (215 lbs/112 Octane)	YA2131L
701-81mm 33cc (200lbs/105 Octane)	YA2133L
701-81mm 34cc (192 lbs/95 Octane)	YA2134L
701-81mm 35cc (185lbs/92 Octane)	YA2135L
701-81mm 37cc (170lbs/91 Octane)	YA2137L

*All ADA Domes are sold individually



**Kawasaki
900/1100
Girdle Billet
Head Shell
& Girdle Kit**



Kawasaki 900/1100

ADA KAWASAKI 900/1100 BILLET HEAD

Kawasaki 900 - 75mm Bore	Part No.
900/1100 Non-Girdle Billet Head Shell	KA900/1100
K900 26cc Dome (185 lbs/105 Octane)	KA9026
K900 28cc Dome (170 lbs/95 Octane)	KA9028
K900 30cc Dome (155 lbs/91 Octane)	KA9030
K900 O-Ring Kit	ORKITK900

*All ADA Domes are sold individually

Kawasaki 1100 - 82mm Bore	Part No.
900/1100 Non-Girdle Billet Head Shell	KA900/1100
900/1100 Girdle Billet Head Shell	KA1100M
Girdle Kit for KA1100M	KA1100G
K1100 22cc Dome (215 lbs/112 Octane)	KD1222
K1100 24cc Dome (200 lbs/108 Octane)	KD1224
K1100 26cc Dome (185 lbs/105 Octane)	KD1226
K1100 28cc Dome (170 lbs/95 Octane)	KD1228
K1100 30cc Dome (155 lbs/91 Octane)	KD1230
K1100 32cc Dome (145 lbs/89 Octane)	KD1232
K1100 O-Ring Kit	ORKITK1100

*All ADA Domes are sold individually

Special Race Dome with a 3" squish angle and a wider squish band (closer to 50% of the bore size)

Description	Bore Size	Dome Size	Part No.
K1100 Race Dome	82mm	22cc	KD8222
K1100 Race Dome	82mm	24cc	KD8224
K1100 Race Dome	82mm	26cc	KD8226
K1100 Race Dome	82mm	28cc	KD8228
K1100 Race Dome	82mm	30cc	KD8230
K1100 Race Dome	82mm	32cc	KD8232

Description	Bore Size	Dome Size	Part No.
K1100 Race Dome	85mm	22cc	KD8522
K1100 Race Dome	85mm	24cc	KD8524
K1100 Race Dome	85mm	26cc	KD8526
K1100 Race Dome	85mm	28cc	KD8528
K1100 Race Dome	85mm	30cc	KD8530
K1100 Race Dome	85mm	32cc	KD8532

*All ADA Domes are sold individually



**KU150 Kawasaki
Ultra 150/STX-R
NON Girdle Head Shell**

ADA KAWASAKI ULTRA 150/STX-R BILLET GIRDLE HEAD KIT

Kawasaki - 80.5mm Bore	Part No.
Ultra 150/STX-R Billet Head Shell (Non Girdle Head)	KU150
Ultra 150 32cc Dome +70 Lbs/112 Octane	KU1532
Ultra 150 36cc Dome +50 Lbs/105 Octane	KU1536
Ultra 150 38cc Dome +40 lbs/105 Octane	KU1538
Ultra 150 40cc Dome +30 lbs/98 Octane	KU1540
Ultra 150 42cc Dome +20 lbs/91 Octane	KU1542
Ultra 150 44cc Dome +10 Lbs/91 Octane	KU1544
Ultra 150/STX-R O-Ring Kit	ORKITKU150

*All ADA Domes are sold individually

**Sea-Doo
720/800**



ADA SD720 AND 800 BILLET HEAD

Sea-Doo - 82mm Bore	Part No.
Sea-Doo 720 Billet Head Shell	SD720
Sea-Doo 720 32cc Dome (205 lbs/100 Octane)	SD7232
Sea-Doo 720 34cc Dome (190 lbs/105 Octane)	SD7234
Sea-Doo 720 36cc Dome (175 lbs/100 Octane)	SD7236
Sea-Doo 800 Billet Head Shell	SD800
Sea-Doo 800 39cc Dome (205 lbs/105 Octane)	SD8039
Sea-Doo 800 41cc Dome (190 lbs/98 Octane)	SD8041
Sea-Doo 800 43cc Dome (175 lbs/91 Octane)	SD8043
Upper Dome O-Ring (2 Each Per Head)	OR020
Upper Head Shell O-Ring (2 Each Per Head)	OR024

*All ADA Domes are sold individually

**The ADA Sea-Doo 720 & 800 domes are interchangeable but the head billet shells are engine size specific.



**Sea-Doo
951**

ADA SD951 BILLET HEAD

Sea-Doo - 89mm Bore	Part No.
Sea-Doo 951 Billet Head Shell	SD951
Sea-Doo 951 38cc Dome (220 lbs/115 Octane)	SD9538
Sea-Doo 951 40cc Dome (210 lbs/112 Octane)	SD9540
Sea-Doo 951 42cc Dome (200 lbs/110 Octane)	SD9542
Sea-Doo 951 46cc Dome (183 lbs/105 Octane)	SD9546
Sea-Doo 951 48cc Dome (175 lbs/98 Octane)	SD9548
Sea-Doo 951 50cc Dome (165 lbs/91 Octane)	SD9550
O-Ring Kit	ORKIT-SD951

*All ADA Domes are sold individually

FOUR STROKE
INTAKE SYSTEMS
ENGINE/GASKETS
EXHAUST
DRIVE LINE HANDLING
ELECTRICAL
WATERLINE /BILGE
STEERING & CONTROLS
BODY
ACCESSORIES SERVICE TOOLS /HARDWARE
CHEMICAL

FOUR STROKE
INTAKE SYSTEMS
ENGINE/GASKETS
EXHAUST
DRIVE LINE HANDLING
ELECTRICAL
WATERLINE /BILGE
STEERING & CONTROLS
BODY
SERVICE TOOLS ACCESSORIES
SERVICE TOOLS ACCESSORIES
SERVICE TOOLS ACCESSORIES
CHEMICAL



KA800G



KA800M
KAWASAKI
800SXR/750
GIRDLE HEAD
SHELL



ADA 800SXR/750
Throttle/Choke Cable Bracket



KA800
KAWASAKI
800SX-R/750
NON-GIRDLE
BILLET
HEAD SHELL

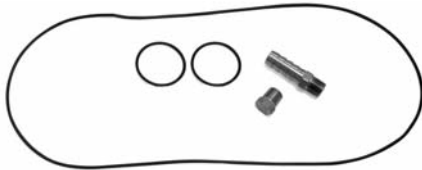

ADA INDIVIDUAL O-RING

Descriptions	Part No.
A. O-Ring, Dome Top Around Spark Plug Hole	OR020
B. O-Ring Head Shell to Dome	OR024
C. Compression O-Ring Ultra 150, All Yamaha	OR043
D. Compression O-Ring SD 951	OR044
E. Outer Water O-Ring Ultra 150 (3 req.)	OR049
F. Outer Water O-Ring Y701/760	ORYA701
Compression O-Ring K750/800	OR042

ADA KAWASAKI 800SXR BILLET HEAD

This head uses the stock head bolts and is completely sealed by O-rings, no head gasket required. Dual water outlets for additional cooling. This head will work with Factory Pipe's 800 dry pipe. **All ADA Domes are sold individually.**

Kawasaki - 82mm Bore	Part No.
800SXR/750 Non-Girdle Head Shell	KA800
800SXR/750 Girdle Head Shell**	KA800M
800SXR/750 Girdle Kit	KA800G
800SXR Dome 22cc (225 lbs.-114 Octane)	KA8022
800SXR Dome 24cc (216 lbs.-110 Octane)	KA8024
800SXR Dome 26cc (208 lbs.-105 Octane)	KA8026
800SXR Dome 28cc (200 lbs.-98 Octane)	KA8028
800SXR Dome 30cc (190 lbs.-95 Octane)	KA8030
800SXR Dome 32cc (180 lbs.-91 Octane)	KA8032
800SXR/750 Throttle/Choke Cable Bracket	KA800BRK-CARB
to use with stock carburetors with ADA Billet Girdle Head	
800SXR/750 O-Ring Kit	ORKITK750

ADA KAWASAKI 800 SXR LIMITED SPEC. DOMES

Billet limited drop dome for the Kawasaki 800 SX-R. These domes have a .050" drop at 82mm for use in Limited engines with a .060" base gasket. Available in 22, 24, 26, 28 & 29cc sizes.

Kawasaki - 82mm Bore	Part No.
800SXR LTD Dome 22cc	KA8222D50
800SXR LTD Dome 24cc	KA8224D50
800SXR LTD Dome 26cc	KA8226D50
800SXR LTD Dome 28cc	KA8228D50
800SXR LTD Dome 29cc	KA8229D50

ADA KAWASAKI 750 BILLET HEAD

Kawasaki - 81mm Bore	Part No.
750/800SXR Non-Girdle Head Shell	KA800
750/800SXR Girdle Head Shell**	KA800M
750/800SXR Girdle Kit	KA800G
K750 20cc Dome (225 lbs.-115 Octane)	KA7520
K750 22cc Dome (210 lbs.-110 Octane)	KA7522
K750 24cc Dome (195 lbs.-100 Octane)	KA7524
K750 26cc Dome (180 lbs.-92 Octane)	KA7526
K750 28cc Dome (165 lbs.-91 Octane)	KA7528
K750 30cc Dome (150 lbs.-89 Octane)	KA7530
K750 O-Ring Kit	ORKITK750

*All ADA Domes are sold individually

**ADA 750/800SXR Girdle and Non-Girdle Head Shell fits both Kawasaki 750 and 800 but must use the ADA 750 Domes.

ADA RACING KAWASAKI 750/800 V2 BILLET GIRDLE HEAD & DOMES



This is ADA Racing's V2 billet girdled head kit for Kawasaki 750/800 engines. This girdled head uses offset base nuts and requires grinding on the outside of the cylinder to make clearance for the girdle studs. ADA also changed to larger diameter domes, so going from a standard bore to a big bore just requires new domes and not a new head.

Kawasaki	Part No.
800SXR/750 V2 Girdle Head Shell	KA800M2
800SXR/750 V2 Girdle Kit	KA800G2
800SXR/750 O-Ring Kit	ORKITK800BB

82-83mm Bore Size Domes		83.5-85mm Big Bore Size Domes	
22cc	KA8322	22cc	KA8522
24cc	KA8324	24cc	KA8524
26cc	KA8326	26cc	KA8526
28cc	KA8328	28cc	KA8528
30cc	KA8330	30cc	KA8530
		32cc	KA8532
		34cc	KA8534



KOMMANDER KAW 800 SXR BILLET HEAD KIT

Description	Part No.
Kommander SXR Billet Girdle Head (Domes Sold Separately)	KOM-101
Kommander SXR Billet Non Girdle Head (Domes Sold Separately)	KOM-102
Kommander SXR Replacement O-Ring Kit	KOM-101-O-RING
Kommander SXR Girdle Hardware Kit	KOM-101-HARDWARE

Description	Bore Size	Dome Size	Part No.
K800SXR Dome	82mm	24cc	KOM-822400-SXR
K800SXR Dome	82mm	27cc	KOM-822700-SXR
K800SXR Dome	82mm	28cc	KOM-822800-SXR
K800SXR Dome	82mm	29cc	KOM-822900-SXR



KOMMANDER KAW TRIPLE 1100/1200 HEAD & DOMES

Billet Aluminum Head & Domes, Fits all 1100 triple Kawasaki motors.

Kommander Industries billet aluminum domes are made for racing, utilizing custom dome architecture for maximum fuel burn and horsepower gains, these domes are ready for the races. Domes are sold individually.

Description	Part No.
Kommander 1100 Billet Girdle Head Black (O-Ring Kit and Two 90° Head Water Fittings Included)	KOM-110-GZXI
Kommander 1100 Billet Head O-Ring Kit	KOM-110-O-RING
Kommander Girdle Head Hardware Kit	KOM-110-HARDWARE

Description	Bore Size	Dome Size	Part No.
K1100/1200 Dome	82mm	24cc	KOM-822400-ZXI
K1100/1200 Dome	82mm	26cc	KOM-822600-ZXI
K1100/1200 Dome	82mm	28cc	KOM-822800-ZXI
K1100/1200 Dome	82mm	30cc	KOM-823000-ZXI
K1100/1200 Dome	82mm	32cc	KOM-823200-ZXI
K1100/1200 Dome	85mm	24cc	KOM-852400-ZXI
K1100/1200 Dome	85mm	26cc	KOM-852600-ZXI
K1100/1200 Dome	85mm	28cc	KOM-852800-ZXI
K1100/1200 Dome	85mm	30cc	KOM-853000-ZXI

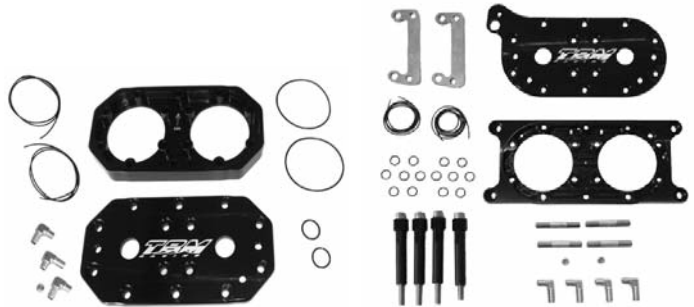

TBM107

TBM107-G

TBM KAW 800 SXR BILLET HEAD KIT

Description	Part No.
TBM Kawasaki 750/800 Non Girdle Head Kit	TBM107
TBM Kawasaki SX-R 800 Girdle Head Kit	TBM107-G
TBM O-Ring Replacement Kit (Fits Part# 107 & 107-G)	TBM107-O
TBM Big Bore O-Ring Kit	TBM107-O-BB

TBM Dome Specification	Dome Size	Base Gasket	Part No.
(Ltd/SS 215psi +)	24cc	Stock	TBM024
Big Bore	24cc	1.5mm	TBM024-L-BB
(Ltd/SS 210psi +)	26cc	Stock	TBM026
(+.050")	26cc	1.5mm	TBM026-L
Big Bore (+.050")	26cc	1.5mm	TBM026-L-BB
(+.050")	27cc	1.5mm	TBM027-L
Big Bore (+.050")	27cc	1.5mm	TBM027-L-BB
(Ltd 185psi)	28cc	Stock	TBM028
Big Bore (+.050")	29cc	1.5mm	TBM029-L-BB
(Ltd 170-175psi)	30.5cc	1.5mm	TBM30.5-L
(+.050" Pump Gas)			
(Ltd, Pump Gas)	30.5cc	Stock	TBM30.5

*Ltd = Limited *SS = Superstock

Description	Part No.
800 SXR .060" - 1.5mm Base Gasket	7040F



O-RING KIT FOR YAMAHA RIVA RACING HEAD

Head O-Ring Kit	Part No.
Yamaha 2 Cylinder (701/760)	RY10026-O
Yamaha 3 Cylinder (63M/65U)	RY10028-O
Yamaha GP800 (66E)	RY100277-O



O-RING SET FOR R&D HEAD

O-Ring Kit	Part No.
Sea-Doo 951 O-Ring Set of 2	080-95000
O-Ring Kit	Part No.
Yamaha 701/760 O-Ring Set of 2	080-76000
O-Ring Kit	Part No.
Kawasaki 750 O-Ring Set of 2	080-75000
Kawasaki 800 O-Ring Set of 2	080-80000

O-RING SET FOR BLOWSION HEAD

O-Ring Kit	Part No.
Yamaha 701/760 O-Ring Set	01-03-231

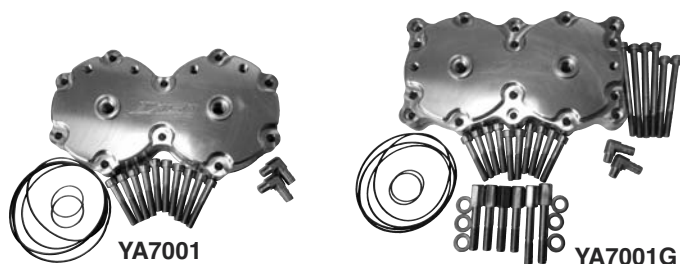

DASA HEAD BILLET

Dasa head 701 head kits only accepts the Dasa 85mm domes listed above. Dasa head kits include all hardware and O-rings for installation as pictured.

Description	Part No.
Y701 Cylinder Head Non-Girdle	YA7001
Y701 Cylinder Head Girdle (Includes girdle hardware)	YA7001G

Yamaha 701	Dome Size	Part No.
701-81mm Dome	30cc	WC-3081
701-81mm Dome	32cc	WC-3281
701-81mm Dome	35cc	WC-3581
701-81mm Dome	37cc	WC-3781
O-ring Kit for 701		WC-OR81

Yamaha 760	Dome Size	Part No.
760-84mm Dome	32cc	WC-3284
760-84mm Dome	34cc	WC-3484
760-84mm Dome	36cc	WC-3684
760-84mm Dome	38cc	WC-3884
O-ring Kit for 760		WC-OR84



DASA RACING KAWASAKI TRIPLE 1100/1200 HEAD KIT

DASA Billet Aluminum Head & Domes. Kit includes Head Shell, Three Domes, Girdle Kit and O-Rings. Silver and black heads are available.

Description	Bore Size	Dome Size	Part No.
K1100/1200 Dome	82mm	22cc	KA-2282
K1100/1200 Dome	82mm	24cc	KA-2482
K1100/1200 Dome	82mm	26cc	KA-2682
K1100/1200 Dome	82mm	28cc	KA-2882
K1100/1200 Dome	82mm	30cc	KA-3082
K1100/1200 Dome	85mm	22cc	KA-2285
K1100/1200 Dome	85mm	24cc	KA-2485
K1100/1200 Dome	85mm	26cc	KA-2685
K1100/1200 Dome	85mm	28cc	KA-2885
K1100/1200 Dome	85mm	30cc	KA-3085
1100/1200 O-Ring Kit			KA-7003



R&D DOMINATOR BASE GASKETS

Yamaha	Thickness	Part No.
Superjet	.020" - 0.5mm	070-00020
Superjet	.040" - 1.0mm	070-00040
Superjet	.060" - 1.5mm	070-00060

Kawasaki	Thickness	Part No.
Kaw 750/800	.060" - 1.5mm	071-00060



HIGH PERFORMANCE COPPER BASE GASKETS

Kawasaki	Thickness	Part No.
800SXR	.002" - .0508mm	7040.002
800SXR	.003" - .0762mm	7040.003
800SXR	.005" - .127mm	7040.005
800 SXR	.020" - 0.5mm	B0075020C

HIGH PERFORMANCE FIBER BASE GASKETS

Solid aluminum core with high density fiber facing.

Kawasaki	Thickness	Part No.
800 SXR	.030" - 0.75mm	7040C
800 SXR	.040" - 1.00mm	7040D
800 SXR	.050" - 1.25mm	7040E
800 SXR	.060" - 1.50mm	7040F
800 SXR	.065" - 1.65mm	7040G



KAWASAKI 1100 BASE GASKETS

Solid aluminum core with high density fiber facing.

Kawasaki	Thickness	Part No.
1100 Base	.025" - .64mm	7615.025
1100 Base	.030" - .75mm	7615.030
1100 Base	.040" - 1.00mm	7615.040
1100 Base	.050" - 1.25mm	7615.050
1100 Base	.060" - 1.50mm	7615.060
1100 Base	.065" - 1.65mm	7615.065

★ Column Code Explanations:

- AC** – Original cylinder bore is alloy-chrome plated, Nikasil, or electrofused. The cylinder must be bored to accept the new cylinder sleeve.
- CS** – Original block has a cast-in sleeve liner in the cylinder. The cylinder must be bored out to accept the new cylinder sleeve. The cast-in liner will be bored completely out of the cylinder. Do not try to push out the cast-in liner, cylinder damage may be the result.
- CI** – Original block has a cast-in liner in the cylinder. The cylinder must be bored to accept the new cylinder sleeve. When using a CI style sleeve the cast-in liner will not be completely removed. The sleeve is designed to insert into the iron lined cylinder.
- RS** – Original block has a replacement sleeve. Heat the cylinder to remove the sleeve. Reheat the cylinder to install the new cylinder sleeve.
- CC** – Original barrel is cast-iron. The cylinder must be bored to accept the new cylinder sleeve.

L.A. Sleeve Co.

L.A. Sleeve produces a complete watercraft line of two stroke centrifugally spun iron cylinder sleeves. LASCO sleeves with exact port specifications, chrome-moly iron alloy, high tensile strength material provide the rebuilder with ease if installation, trouble free boring and a lasting long life engine.



MODEL	L.A. SLEEVE	CUBIC DISPLACEMENT	CYLINDER I.D.	CODE	PART NO.
Sea-Doo					
580 Long Finger Port (1988)		580cc	76mm	RS	FL-5102
580 Short Finger Port (1989-96)		580cc	76mm	RS	FL-5125
XP/SPI, GTX, SPX (1993-95)		650cc	78mm	RS	FL-5244
GTI, HX, SPX, XP, GTS, GS, GSI		718cc	82mm	RS	FL-5268
XP/SPX/GTX RFI-785 Rave (1995-2002)		782cc	82mm	RS	FL-5290
GSX/XP/GTX-951 LTD RX (1997-2002)		951cc	88mm	RS	FL-5322
785DI		782cc	82mm	RS	FL-5583
951DI		951cc	88mm	RS	FL-5578
4-Tec 4 Stroke		1494cc	100mm	RS	FL-5500
Polaris					
SL-650 (1992-95)		647cc	65mm	CI	FL-5191
SL-750 (1993-95)		744cc	69.70mm	CI	FL-5239
SLX Pro 785 (1997-2001)			69.72mm	AC	FL-5342
SL-900 (1996-97)		889cc	74.50mm	RS	FL-5305
SLTX/SLXH-1051 (1996-99)		1051cc	81mm		FL-5297
Virage, Octane 777 (2002)		777cc	84mm	RS	FL-5416
Genesis 1200 (1999-2002), SLX, X-45 1200, Pro 1200, Virage TX & TXI (1999-2002)		1165cc	84mm	RS	FL-5416
Yamaha					
Wave Jammer, Wave Runner (1987-92)		496cc	72mm	RS	YA-5025
Wave Runner, Super Jet (thru 1993)		633cc	77mm	RS	YA-5139
61X Wave Blaster, WRIII, FX, Pro VXR, Superjet (1993-2007)		701cc	81mm	RS	YA-5187
Super Jet, Wave Blaster Big Bore		789cc	84mm		YA-5187B
62T 701 Wave Raider (1994-95), Wave Venture XL 700 (1995-2002)		701cc	81mm	RS	YA-5284
Wave Raider, WBII, GP 760/Wave Blaster (1996-00)		754cc	84mm	RS	YA-5304
Wave Runner GP-800 (1998-2002), XL/XLT 800 (2000-02)		784cc	80mm	AC	YA-5356
1100Wave Raider (1995-96), Wave Venture (1996-97)		1051cc	81mm	RS	YA-5282
GP1200(1997-99)/XL 1200 (1998)		1131cc	84mm	RS	YA-5349
XL1200 Ltd/GP1200R		1176cc	80mm	AC	YA-5469
GP1300R (2003-07)		1296cc	84mm	AC	YA-5502
VX110		1052cc	75.95mm	AC	YA-5566
FX Cruiser, FX, FZR, FZS, HO, SHO		1812cc	86mm	AC	YA-5688
FX Cruiser, FX, FZR, FZS, HO, SHO Big Bore 1870cc		1870cc	88mm	BB	YA-5688B
Kawasaki					
JS-550 Iron Cylinder (1986-90)		531cc	75mm	CC	KA-5033
JS-550 SX Reed (1991-95)		531cc	75mm	CI	KA-5135
JS, JF-650 (1986-96)		635cc	76mm	CS	KA-999
JS-750 SX/SS (1992-95)		743cc	80mm	CI	KA-5166
JS-750 SX/SS (1992-95) Special Heavy OD Sleeve 3.600"		743cc	80mm	CS	KA-5166H
JS-750 SXI, ZXI (1996-97), ST (1994-95) SXI Pro		743cc	80mm	CI	KA-5280
JS-750 SX, ZXI (1995-97), ST (1994-95), SXI Pro Special Heavy OD Sleeve 3.600"		743cc	80mm	CS	KA-5280H
JS-900 ZXI, STX (1995-06)		891cc	73mm	CS	KA-5283
JS1100ZXI, STX (1996-2002)		1071cc	80mm	CI	KA-5303
JS-1100 ZXI, STX (1996-2002) Big Bore		1180cc	83mm		KA-5303B
800 SXR (2003-12)		782cc	82mm	CI	KA-5496
Ultra 150 (1999-2000)		1176cc	80mm	AC	KA-5415
STX-12F (2003-07)		1199cc	83mm	AC	KA-5433
Ultra 250X/LX (2007-08), Ultra 260X/LX (2009-10), Ultra 300X/LX (2011-13)		1498cc	83mm	AC	KA-5776
STX-15F (2004-15), Ultra LX (2007-15)		1498cc	83mm	AC	KA-5565

*Sleeve is sold individually

General Rules for Sleeve Installation:

These tips are intended to be a guide for installing sleeves into cylinders. There are always exceptions to the rule and care must be taken on special applications.

ALWAYS WAIT UNTIL THE SLEEVE ARRIVES BEFORE BEGINNING ANY MACHINE WORK. NEVER ASSUME THAT THE STATED MODEL AND YEAR OF THE CYLINDER IS CORRECT. ALWAYS CHECK TO SEE IF THE SLEEVE PORTS MATCH THE CYLINDER PORTS.

1. Interference fit for cylinder sleeve to aluminum bore is .004.
2. Interference fit for cylinder sleeve to a cast iron bore is .002 to .003.
3. Installation of flanged type sleeves follow the same rules, but the top of the cylinder must have a countersink to the correct depth to accept the flanged sleeve. .000 to .001 interference fit on the flange diameter is recommended.
4. Heating the cylinder for 45 minutes to one hour at 350 degrees to 450 degrees is preferable.
5. The sleeve should slide in very easily when the cylinder is properly heated. Freeze shrinking the sleeve is not necessary. (Some machinists believe this assists installation of the sleeve.)
6. **REMEMBER:** Rap or press the sleeve down while the cylinder is cooling down. Use a hydraulic press for this procedure.
7. Milling the top deck of the cylinder always adds a quality touch. A caution here, some cylinders may not be able to have the top surface decked.
8. For two-stroke cylinders, blending or matching the aluminum cylinder to the sleeve ports is recommended for proper fuel flow.

FOUR STROKE
INTAKE SYSTEMS
ENGINE/GASKETS
EXHAUST
DRIVE LINE HANDLING
ELECTRICAL
WATERLINE /BILGE
STEERING & CONTROLS
BODY
ACCESSORIES
SERVICE TOOLS /HARDWARE
CHEMICAL

W WISECO®

Performance Products

PERSONAL WATERCRAFT KITS

All pistons are high quality forged alloy and include rings, taper wall wrist pins and circlips.



The ★ column, next to the sleeve part number, will help the rebuilder identify the cylinder that is to be sleeved.
The ★ column designation will also help the rebuilder to determine the proper installation procedure.

SEE PAGE 139 FOR CODES AND DESCRIPTIONS

Model		Stock Engine Bore x Stroke	★	L.A. SLEEVE	Piston Style	Piston Kit	Bore Size mm	Over Size mm	CC	Ring Set	Circlip	Wrist Pin	Piston Wrist Pin Bearing	Crank Side/End Rod Bearing								
Sea-Doo 580 (Long Finger Port)	1988	76mm x 64mm	RS	FL-5102	E Coated	734M07600	76.00	STD	580	2992TD	CW18	S477	50-4185									
Sea-Doo 580 (Short Finger Port)	1989-96		734M07650			76.50	0.50	588	3012TD													
Explorer 580 / SPX 580	1993		734M07700			77.00	1.00	595	3032TD													
GT 580	1990-1991		734M07750			77.50	1.50	602	3051TD													
GTS 580	1992-1996		78mm x 68mm	RS	FL-5244	L Ring STOCK STYLE	663M07800	78.00	STD	650	3071LK	CW20	S512	50-4184 (1993) 50-4182 (94-95)								
Explorer 650	1994-1996						663M07850	78.50	0.50	658	3091LK											
GTX 650	1994-1995						663M07900	79.00	1.00	666	3110LK											
Speedster 650	1994-1995	663M08000					80.00	1.50	674	3150LK												
Sportster 650	1995	775M08200					RS	FL-5268	L Ring USBA Ltd. Class Legal	775M08250	82.50					0.50	726	8250LF	CW20	S461	50-4184	01321
Sea-Doo 580	1990-1991		775M08300	83.00	1.00	735				8300LF												
SI 580 / ST 580	1990		775M08350	83.50	1.50	744				8350LF												
SP 580 / SPI 580	1991-1996		775M08400	84.00	2.00	754				8400LF												
XP 580	1991-1992		82mm x 68mm	RS	FL-5268	L Ring USBA Ltd. Class Legal				775M08200	82.00	STD	718	8200LF	CW20	S461	50-4184	01321				
Explorer 650	1994-1996									775M08250	82.50	0.50	726	8250LF								
GTX 650	1994-1995	775M08300					83.00	1.00	735	8300LF												
Speedster 650	1994-1995	775M08350					83.50	1.50	744	8350LF												
Sportster 650	1995	775M08400					84.00	2.00	754	8400LF												
SPX 650	1994-1995	82mm x 68mm					RS	FL-5268	L Ring USBA Ltd. Class Legal	775M08200	82.00	STD	718	8200LF					CW20	S461	50-4184	01321
XP 650	1993-1994									775M08250	82.50	0.50	726	8250LF								
718cc Twin Cylinder			775M08300	83.00	1.00	735				8300LF												
Challenger 718	1998		775M08350	83.50	1.50	744				8350LF												
Challenger 718	2000-2001		775M08400	84.00	2.00	754				8400LF												
Explorer 718	1997		82mm x 68mm	RS	FL-5268	L Ring USBA Ltd. Class Legal				775M08200	82.00	STD	718	8200LF	CW20	S461	50-4184	01321				
Explorer 718	2002									775M08250	82.50	0.50	726	8250LF								
GS 718	1997-2001	775M08300					83.00	1.00	735	8300LF												
GSI 718	1997	775M08350					83.50	1.50	744	8350LF												
GTI 718	1996-2005	775M08400					84.00	2.00	754	8400LF												
GTI 718 LE	2002-2004	82mm x 68mm					RS	FL-5268	L Ring USBA Ltd. Class Legal	775M08200	82.00	STD	718	8200LF					CW20	S461	50-4184	01321
GTS 718	1997-2001									775M08250	82.50	0.50	726	8250LF								
HX 718 / XP 718	1995-1997		775M08300	83.00	1.00	735				8300LF												
SP 718	1997		775M08350	83.50	1.50	744				8350LF												
Speedster 718	1996-1997		775M08400	84.00	2.00	754				8400LF												
Speedster 718 SK	1999		82mm x 68mm	RS	FL-5268	L Ring USBA Ltd. Class Legal				775M08200	82.00	STD	718	8200LF	CW20	S461	50-4184	01321				
Sportster 1800 (718)	1998-1999									775M08250	82.50	0.50	726	8250LF								
Sportster 718	1996-1998	775M08300					83.00	1.00	735	8300LF												
Sportster 718 LT	2002	775M08350					83.50	1.50	744	8350LF												
SPX 718	1996	775M08400					84.00	2.00	754	8400LF												

WISECO														
Model	Sea-Doo	Stock Engine Bore x Stroke	★	L.A. SLEEVE	Piston Style	Piston Kit	Bore Size mm	Over Size mm	CC	Ring Set	Circlip	Wrist Pin	Piston Wrist Pin Bearing	Crank Side/End Rod Bearing
780cc Twin Cylinder 3D Base 782 2005 3D Premium 782 2005 Challenger 1800 (782) 1997-1999 Challenger 782 1996-1997 GSX 782 1996-1997 GSX 782 RFI 1999-2000 GTI 782 LE 2005 GTI 782 LE RFI 2003-2005 GTI 782 RFI 2004-2005 GTX 782 1996-1999 GTX 782 RFI 1998-2002 Speedster 782 1998-1999 SPX 782 1997-1999 XP 782 1996-1997 XP-800 LTD (782) 1995 XP-800 LTD (782) 1997		82mm x 74mm	RS	FL-5290	L Ring USBA Ltd. Class Legal	779M08200 779M08210 779M08250 779M08300 779M08350 779M08400	82.00 82.10 82.50 83.00 83.50 84.00	STD 0.10 0.50 1.00 1.50 2.00	780 782 791 801 810 820	8200LF 8210LF 8250LF 8300LF 8350LF 8400LF	CW20	S461	50-4184	01323
950cc Twin Cylinder 3D 950 DI 2006-2007 GSX 950 LTD 1997-1999 GTX 950 2000-2002 GTX 950 DI 2000-2003 GTX 950 LTD 1998-2002 LRV 950 2000-2003 LVR 950 DI 2000-2003 RX 950 2000-2002 RX 950 DI 2000-2003 RXX 950 2001-2002 Sportster 950 LE 2000-2003 Sportster 950 LE DI 2004-2005 VSP 950 LTD 1999-2003 XP 950 2000-2002 XP 950 DI 2003-2004 XP 950 LTD 1998-2003		88mm x 78.2mm	RS	FL-5322		716M08800 716M08850 716M08900 716M08940 716M09000 716M09100	88.00 88.50 89.00 89.40 90.00 91.00	STD 0.50 1.00 1.40 2.00 3.00	951 960 971 982 993 1017	3464KD 3484KD 3503KD 3520KD 3544KD 3584KD	CW21	S568	01242	
Sea-Doo 4-Tec RXP/RXP-X/ RXT/RXT-X all RXP 215 RXP-X 255 RXT 255/260 RXT-X 255/260	2004-2014	100mm x 63.4mm		FL-5500		40038M10000 40038M10050 40038M10100	100.00 100.50 101.00			3937XS 10050XS 10100XS	W5860	S626		

FOUR STROKE
INTAKE SYSTEMS
ENGINE/ GASKETS
EXHAUST
DRIVE LINE HANDLING
ELECTRICAL
WATERLINE /BILGE
STEERING & CONTROLS
BODY
ACCESSORIES
SERVICE TOOLS /HARDWARE
CHEMICAL



40038M1000 / 40038M10050 / 40038M10100

PRO-X SEA-DOO PERFORMANCE STEEL VALVES

Pro-X has developed these valves for the Sea-Doo GTX-4TEC 2003-08 and RXP/RXT 2004-08.

Description	Part No.
Pro-X Sea-Doo Exhaust Valves	28.5594-1
Pro-X Sea-Doo Intake Valves	28.5594-2

*Pro-X Sea-Doo Performance Valves are sold piece.

WISECO														
Model	YAMAHA	Stock Engine Bore x Stroke	★	L.A. SLEEVE	Piston Style	Piston Kit	Bore Size mm	Over Size mm	CC	Ring Set	Circlip	Wrist Pin	Piston Wrist Pin Bearing	Crank Side/End Rod Bearing
650cc Twin Cylinder Super Jet 1990-1993 WaveRunner III 1996 WaveRunner VXR (from 817001) 1992-1995		77mm x 68mm	RS	YA-5139		602M07700 602M07750 602M07800 602M07850	77.00 77.50 78.00 78.50	STD 0.50 1.00 1.50	633 641 649 658	3032TD 3051TD 3071TD 3091TD	CW20	S423	50-3302	01325
WaveRunner 1991-1992 WaveRunner LX 1993 WaveRunner III 1990-1995 WaveRunner VXR (from 816999) 1991-1992		77mm x 68mm	RS	YA-5176										

		WISECO											Piston Wrist	Crank Side/End					
Model YAMAHA		Stock Engine Bore x Stroke	L.A. SLEEVE	Piston Style	Piston Kit	Bore Size mm	Over Size mm	CC	Ring Set	Circlip	Wrist Pin	Pin Bearing	Rod Bearing						
FOUR STROKE	701cc Twin Cylinder	81mm x 68mm	RS	YA-5187		790M08100	81.00	STD	701	3189KD	CW20	S631	50-3483	01325					
	FX-1 700 1994-1995					790M08150	81.50	0.50	710	3207KD									
	Super Jet 700 1994-2010					790M08200	82.00	1.00	718	3228KD									
	Wave Blaster 700 1993-1996					790M08250	82.50	1.50	726	3248KD									
	Wave Raider 700 1996-1997					790M08300	83.00	2.00	735	3268KD									
	Wave Runner III GP 700 1994-1997					790M08400	84.00	3.00	753	3307KD									
	PRO VXR 700 1993-1994																		
INTAKE SYSTEMS	701cc Twin Cylinder		RS	YA-5284															
	Wave Raider 700 1994-1995																		
	Wave Raider 700 Deluxe 1995-1996																		
	Wave Runner XL 700 1999-2004																		
	Wave Venture 700 1995-1998																		
Wave Venture XL 700 2002																			
ENGINE/GASKETS	760cc Twin Cylinder	84mm x 86mm	RS	YA-5304		757M08400	84.00	STD	754	3307KD	CW20	S631	50-3483	01325					
	Wave Blaster 760 1996-1997					757M08450	84.50	0.50	763	3327KD									
	Wave Raider 760 1996-1997					757M08500	85.00	1.00	771	3347KD									
	Wave Runner II 760 1996-1997					757M08550	85.50	1.50	780	3368KD									
	Wave Venture 760 1997					757M08600	86.00	2.00	789	3385KD									
						* Cylinder Sleeving Required for 85.5mm and 86mm bore.													
EXHAUST	784cc Twin Cylinder	80mm x 78mm	AC	YA-5356		758M08000	80.00	STD	784	3150KD	CW22	S640	01343						
	Wave Runner GP 800 1998-2005					758M08100	81.00	1.00	794	3189KD									
	Wave Runner XL 800 2000-2001					Ceramic Composite Bore													
	Wave Runner XLT 800 2002-2004																		
DRIVE LINE HANDLING	1100cc Triple Cylinder	81mm x 68mm	RS	YA-5282		791M08100	81.00	STD	1051	3189KD	CW20	S512	50-3483	01325					
	Wave Raider 1100 1995-1996					791M08150	81.50	0.50	1064	3207KD									
	Wave Venture 1100 1996-1997					791M08200	82.00	1.00	1077	3228KD									
ELECTRICAL	1200cc Triple Cylinder	84mm x 68mm	RS	YA-5349		757M08400	84.00	STD	1131	3307KD	CW20	S631	50-3483	01325					
	Wave Runner GP 1200 1997-1999					757M08450	84.50	0.50	1142	3327KD									
	Wave Runner SUV 1200 1999-2004					757M08500	85.00	1.00	1156	3347KD									
	Wave Runner XL 1200 1998					757M08550	85.50	1.50	1169	3366KD									
						757M08600	86.00	2.00	1184	3386KD									
WATERLINE /BILGE	1200cc Triple Cylinder	80mm x 78mm	AC	YA-5469		758M08000	80.00	STD	1176	3150KD	CW22	S640	01343						
	Wave Runner GP 1200 2000-2002					758M08100	81.00	1.00	1191	3189KD									
	Wave Runner XL 1200 LTD 1999-2000																		
STEERING & CONTROLS	GP1300R	84mm x 78mm	AC	YA-5502		867M08400	84.00	STD	1300	3307KD	CW22	S539							
	998cc Four Cylinder	74mm x 58mm		YA-5501		4707M07400	74.00	STD	998	2913XA	W6431	S532							
FX140/FX140 Cruiser 2002-2006	11.4:1 Compression																		
STEEERING & CONTROLS	1050cc Four Cylinder	76mm x 58mm		YA-5866		40051M07600	76.00	STD	1052.6	2992XG	CW17	S532							
	VX1050 Cruiser														11.4:1 Compression				
	VX1050 Sport																		
BODY	1800cc Four Cylinder	86mm x 78mm		YA-5688		40049M08600	86.00	STD	1812.7	8600XX	W5590	S734							
	FX Cruiser SHO 2008-2012														8.6:1 Compression				
	FX SHO 2008-2011																		
	FZR 2009-2012																		
FZS 2009-2012																			



PRO-X CAM CHAINS

Manufactured by Borg Warner in Japan to OEM specifications. Strong M-type chain with heat treated pins for maximum performance and durability.

Description	Part No.
Yamaha FX140 (02-08)	31.1997
Yamaha VX1100 (07-08)	31.1997
Kawasaki STX-12F (03-07)	31.4903
Kawasaki STX-15F (04-08)	31.4903
Kawasaki Ultra 250X (07-08)	31.4907
Kawasaki Ultra 260X (09-10)	31.4907



2012 IJSBA HOT PRODUCTS WORLD FINALS IN LAKE HAVASU CITY, ARIZONA.

Model KAWASAKI	Stock Engine Bore x Stroke	★	L.A. SLEEVE	Piston Style	Piston Kit	Bore Size mm	Over Size mm	CC	Ring Set	Circlip	Wrist Pin	Piston Wrist Pin Bearing	Crank Side/End Rod Bearing
550cc Twin Iron Cylinder 550SX 1989-1991 JS550 1982-1988	75mm x 60mm	CC	KA-5033		516M07500 516M07550 516M07600	75.00 75.50 76.00	STD 0.50 1.00	531 537 544	2953TC 2973TC 2992TC	CW16	S259	50-3122	
550cc Twin Cylinder (Reed) 550SX 1992-1995 Crankcase machining required for 76.5mm and larger	75mm x 60mm	CC	KA-5135		608M07500 608M07550 608M07600 608M07650	75.00 75.50 76.00 76.50	STD 0.50 1.00 1.50	531 537 544 551	2953TD 2973TD 2992TD 3012TD	CW16	S259	50-3122	
650cc Twin Cylinder 650 SX 1987-1993 SC 650 1991-1995 TS 650 1989-1996 X-2 (650) 1986-1995 Crankcase machining required for 77.5mm and larger	76mm x 70mm	CS	KA-999		549M07600 549M07650 549M07700 549M07750 549M07800	76.00 76.50 77.00 77.50 78.00	STD 0.50 1.00 1.50 2.00	635 643 657 660 668	2992TD 3012TD 3032TD 3051TD 3071TD	CW18	S513	50-3272	01315
750cc Twin Cylinder 20mm Pin 750 SS / SX 1992-1995 750 ZXi 1995 ST 750 1993-1995 STS 750 1995 Super Sport Xi 750 1993-1995 XiR 750 1994 Crankcase machining required for 83mm and larger	80mm x 74mm	CI	KA-5166		813M08000 813M08050 813M08100 813M08150 813M08200 813M08300 813M08500 813M08550	80.00 80.50 81.00 81.50 82.00 83.00 85.00 85.50	STD 0.50 1.00 1.50 2.00 3.00 5.00 5.50	743 752 760 771 779 796 840 849	3150KD 3169KD 3189KD 3209KD 3228KD 3268KD 3347KD 3367KD	CW20	S650 (20mm)	50-3302	01317
<p>SJ Flat Top Piston 85.0 mm for SJ 771CC 85.5 mm for SJ 780CC Piston skirt must be modified to match sleeve</p>													
750cc Twin Cylinder 22mm Pin 750 SS 1996-1997 750 STX 1998 750 ZXi 1996-1997 STS 750 1996-1997 Super Sport Xi 750 1996-1997 Xi Sport 750 1998-1999 Crankcase machining required for 83mm and larger	80mm x 74mm	CI	KA-5280		809M08000 809M08050 809M08100 809M08150 809M08200 809M08300 809M08400 809M08450	80.00 80.50 81.00 81.50 82.00 83.00 84.00 84.50	STD 0.50 1.00 1.50 2.00 3.00 4.00 4.50	743 752 760 771 779 795 820 830	3150KD 3169KD 3189KD 3207KD 3228KD 3268KD 3307KD 3327KD	CW22	S662 (22mm)	50-3304	
<p>Replaces 623 series with KD rings, stronger forging and stronger 20mm pin</p> <p>Replaces 733 series with KD rings, stronger forging and stronger 22mm pin</p> <p>← 800SXR Gasket 7000BB-8470 84.70mm</p>													
750cc Twin Cylinder 750 SXi 1995-1996 750 SXi Pro 1998-2002 800 SX-R 2003-2011 * These racing pistons feature a cutaway skirt, boost port feed hole, and thinner rings. Team Kawasaki Factory Part	80mm x 74mm	CI	KA-5280	Electra Coated	810M08250 810M08296	82.50 82.96	2.50 2.96	791 800	8250KB 8300KB	CW22	S640	50-3304	
800cc 800 SX-R 2003-2011	82mm x 74mm		KA-5496 KA-5496H		837M08200 837M08250 837M08296	82.00 82.50 82.96	STD 0.50 0.96	782 791 800	3228KD 3248KD 3268KD	CW22	S662	50-3304	
900cc Triple Cylinder 900 STS 2001-2002 900STX 1997-2006 900ZXi 1995-1997	80mm x 71mm	CS	KA-5283		659M07300 659M07350 659M07400 659M07450	73.00 73.50 74.00 74.50	STD 0.50 1.00 1.50	891 903 915 928	2874CD 2894CD 2913CD 2933TD	CW20	S512	50-3302	01317
1100cc Triple Cylinder/Big Pin 1100 STX 1997-1999 1100 ZXi 1996-2003 Crankcase machining & resleeving required for 83mm and larger	80mm x 71mm		KA-5303		809M08000 809M08050 809M08100 809M08150 809M08200 809M08300 809M08400 809M08450	80.00 80.50 81.00 81.50 82.00 83.00 84.00 84.50	STD 0.50 1.00 1.50 2.00 3.00 4.00 4.50	1071 1083 1097 1106 1125 1151 1179 1193	3150KD 3169KD 3189KD 3209KD 3228KD 3268KD 3307KD 3327KD	CW22	S662	50-3304	01317
<p>KA5303B Big Bore to 1207cc</p>													
1200cc Triple Cylinder Ultra 150 (1200) 1999-2005	80mm x 78mm	AC	KA-5415		749M08000 749M08050	80.00 80.50	STD 0.50	1176 1191	3150TD 3169TD	CW24	S598	50-4186	
1500 Four Cylinder Ultra 260 LX 2009-2010 Ultra 260 X 2009-2010	83mm x 69.2mm		KA-5776		40048M0830	83.0	STD	1498	8300XX	CW28	S624		
1500 Four Cylinder Ultra LX 2007-2012 STX 15-F 2004-2012 STX 2009-2010	83mm x 69.2mm		KA-5565		40052M0830	83.0	STD	1498	3268XG	CW21	S561		

FOUR STROKE
INTAKE SYSTEMS
ENGINE/ GASKETS
EXHAUST
DRIVE LINE HANDLING
ELECTRICAL
WATERLINE /BILGE
STEERING & CONTROLS
BODY
ACCESSORIES
SERVICE TOOLS /HARDWARE
CHEMICAL



PRO-X VALVE SHIM KIT

Easy and economical replacement shims. Precision machined to match the exact size. Specific heat-treatment ensuring hardness to offer maximum durability and less wear.

Description Part No.

Pro-X Valve Shim Kit **29.VSA948**
*This Pro-X Valve Shim Kit is for Kawasaki:
STX-12F (03-04), STX-15F (04-09),
Ultra LX (07-09), Ultra 250X (07-08),
Ultra 260X (09-10)

FOUR STROKE
INTAKE SYSTEMS
ENGINE/GASKETS
EXHAUST
DRIVE LINE HANDLING
ELECTRICAL
WATERLINE /BILGE
STEERING & CONTROLS
BODY
ACCESSORIES
SERVICE TOOLS /HARDWARE
CHEMICAL

Model		Stock Engine Bore x Stroke	L.A. SLEEVE	Piston Style	Piston Kit	Bore Size mm	Over Size	CC	Ring Set	Circlip	Wrist Pin	Piston Wrist Pin Bearing	Crank Side/End Rod Bearing
650cc Triple Cylinder SL 650 1992-1995 SL 650 STD 1995		65mm x 65mm	CI FL-5191		624M06500 624M06550 624M06600 624M06700	65.00 65.50 66.00 67.00	STD 0.50 1.00 2.00	647 656 665 685	2559CD 2579CD 2598CD 2638CD	CW18	S280	50-3496	01329
700cc Twin Cylinder Hurricane 700 1996-1997 Freedom 700 2002-2004 SL 700 1996-1997 SL 700 Deluxe 1997 SLH 700 1998-2001 SLT 700 1996-1997 SLTH 700 1998-1999 Virage 700 2002-2004		81mm x 68mm	RS FL-5300 FL-5341		700M08100 700M08150 700M08200 700M08250 700M08300	81.00 81.50 82.00 82.50 83.00	STD 0.50 1.00 1.50 2.00	700 710 718 726 734	3189TD 3209TD 3228TD 3248TD 3268TD	CW20	S512	50-4182	
750cc Triple Cylinder SL 750 1993-1995 SLT 750 1994-1995		69.8mm x 65mm	CI FL-5239 CS FL-5239H Special Heavy O.D. 80.60mm		633M06975 633M07025 633M07075 633M07125 633M07150 633M07200	69.75 70.25 70.75 71.25 71.50 72.00	STD 0.50 1.00 1.50 1.75 2.25	744 755 766 777 783 795	2746CD 2766CD 2786CD 2805CD 2815CD 2835CD	CW18	S343	50-3496	01329
777cc Triple Cylinder Octane 777 2002-2004 Virage i 777 2002-2004		84mm x 70mm	FL-5416	E-Coated	811M08400 811M08450 811M08500 811M08525 812M08500 812M08525	84.00 84.50 85.00 85.25 85.00 85.25	775.8 785.1 794.4 799.1 794.4 799.1	744 755 766 777 783 795	8400KB 8450KB 8500KB 8520KB 8500KB 8525KB	CW22	S662		
785cc Triple Cylinder PRO 785 1999-2000 SLX PRO 785 1997-1998		69.7mm x 68mm	FL-5342	XPS E-Coated	722M06970	69.70	STD	799	2746CD	CW18	S343		
780cc Triple Cylinder SL 780 1996-1997 SLT 780 1996-1997 SLX 780 1995-1996		71.3mm x 65.0mm	FL-5302		633M07150 633M07200	71.50 72.00	STD 0.71	783 794	2815CD 2835CD	CW18	S343	50-3496	01329
900cc Triple Cylinder SL 900 1996-1997		74.5mm x 68mm	RS FL-5305		687M07450 687M07500 687M07550	74.50 75.00 75.50	STD 0.50 1.00	889 901 913	2933TD 2953TD 2973TD	CW20	S512	50-4182	
1050cc Triple Cylinder SL 1050 1997 SLTX 1050 1996-1999 SLX 1050 1999 SLXH 1050 1998		81mm x 68mm	FL-5297		781M08100 781M08150 781M08200 781M08250	81.00 81.50 82.00 82.50	STD 0.50 1.00 1.50	1051 1064 1077 1090	8100LF 8150LF 8200LF 8250LF	CW20	S512	50-4182	
1200cc Triple Cylinder Genesis 1200 1999-2002 Genesis FFI 1200 1999-2000 Genesis Ficht 1200 1999 Genesis i 1200 2001-2004 PRO 1200 2000-2001 SLTX-B (X-45) 1200 1999 SLX 1200 2000-2001 Virage TX 1200 2000-2002 Virage TXI 1200 2001-2002		84mm x 70mm	FL-5416		811M08400 811M08450 811M08500 811M08525	84.00 84.50 85.00 85.25	STD 0.50 1.00 1.25	775.8 785.1 794.4 799.1	8400KB 8450KB 8500KB 8525KB	CW22	S662		
1200cc Triple Cylinder Octane 777 2002-2004 PRO 1200 2000-2001 MSX 140 H.O.(1200) 2003-2004		85mm	RS FL-5305		812M08500 812M08525	85.00 85.25	1.00 1.25	794.4 799.1	8500KB 8525KB	CW22	S662		
<i>Low Dome Race Part. (Flat Top) Head Modifications required.</i>													



2015 IJSBA QUAKYSENSE WORLD FINALS
IN LAKE HAVASU CITY, ARIZONA.
PHOTO COURTESY OF JIN OMURA.

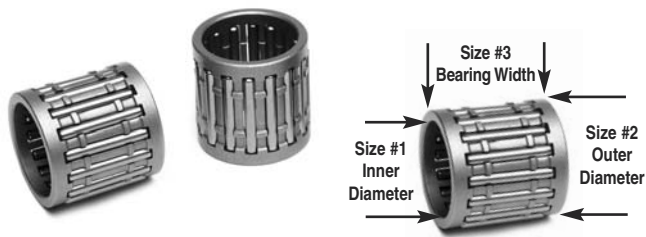

TOP END (WRIST PIN) BEARINGS

Kawasaki	OEM No.	Size (1x2x3)	Part No.	
300	1986-93	13033-1010	18x22x24	50-3272
440	1977-92	13033-3005	16x20x22.5	50-3122
550	1982-95	13033-3005	16x20x22.5	50-3122
650 SX,X2,TS,SC	1986-96	13033-1010	18x22x24	50-3272
750 ST,SX,SS,XiR,Supersport Xi	1992-95	13033-3702	20x25x25	50-3302
900 ZXI,STX	1995-06	13033-3702	20x25x25	50-3302
750 ZXI,STX,SXi,STS,Xi Sport,SXi Pro.Supersport Xi	1996-02	13033-3703	22x27x24.7	50-3304
800 SXR	2003-12	13001-3735	22x27x24.7	50-3304
1100 ZXi,STX	1996-02	13033-3703	22x27x24.7	50-3304
Ultra 150,STX-R	13033-3704	24x29x25	50-4186	

Polaris	OEM No.	Size (1x2x3)	Part No.	
650	1987-92	3083216	18x23x21.5	50-3496
750	1987-92	3083216	18x23x21.5	50-3496
780	1987-92	3083216	18x23x21.5	50-3496
700	1995-97	3584001	20x25x21.7	50-4182
900	1997-02	3584001	20x25x21.7	50-4182
1050	1998-02	3584001	20x25x21.7	50-4182

Tiger Shark	OEM No.	Size (1x2x3)	Part No.	
640/900/1000	1993-99	—	20X26X24	B1024

Sea-Doo	OEM No.	Size (1x2x3)	Part No.	
580	1988-96	290.832.320	18x22x22	50-4185
650	1993	290.832.440	20x24x23	50-4184
650	1994-95		20x25x21.7	50-4182
720	1995-02	290.832.420	20x24x23	50-4184
785	1995-02	290.832.420	20x24x23	50-4184
951	1997-02	290.832.550	21x25x24	01242

Yamaha	OEM No.	Size (1x2x3)	Part No.	
500	1987-92	20x24x23	50-4184	
650	thru 1996	933310-320U200	20x25x25	50-3302
701/760	thru 2012*		20x25x24	50-3483
1100	1995-97		20x25x24	50-3483
1200 (65U)	1997-02		20x25x24	50-3483
800	1998-02		22x27x23	01343
1200 (66V)	1998-02		22x27x23	01343

*Must use OEM Washer

BIG END (CRANK PIN) BEARINGS

Sea-Doo	Size	Part No.
720	26 x 33 x 18	01321
785	28 x 35 x 18	01323

Yamaha	Size	Part No.
650/701/760/1100	25 x 32 x 20	01325



Kawasaki	Size	Part No.
JS/JF-650	24 x 32 x 20	01315
JS750 93-95	26 x 34 x 20	01317
JS900ZXI	24 x 34 x 20	01317
JS1100ZXI	24 x 34 x 20	01317

Polaris	Size	Part No.
650/750/780	24 x 32 x 16	01329

HOT ROD THRUST WASHERS

Determine part number by size.

ID Size	Thickness	Part No.
25mm	X 1mm	W111
26mm	X 1mm	W113
28mm	X 1mm	W116
32mm	X 1mm	W118



THRUST WASHERS

Determine part number by size.

ID Size	Thickness	Part No.
24mm	X 1mm (coated)	TW4942
25mm	X 1mm	TW4968



YUJI SHIRUKI AND HIROTSUGU KITAJIMA SHOW OFF THEIR SQUARE NOSE SUPERJET AT THE 2015 IJSBA QUAKYSENSE WORLD FINALS IN LAKE HAVASU CITY, ARIZONA. PHOTO COURTESY OF JIN OMURA.

100*212	95*203	90*194	85*185	80*176	75*167	70*158	65*149	60*140	55*131	50*122	45*113	40*104
100*212	95*203	90*194	85*185	80*176	75*167	70*158	65*149	60*140	55*131	50*122	45*113	40*104
100*212	95*203	90*194	85*185	80*176	75*167	70*158	65*149	60*140	55*131	50*122	45*113	40*104

WATCON TEMPERATURE STRIPS

They can be placed on cylinders, heads, exhaust system components, collectors, etc. We use them to monitor differences or changes between cylinders or pipes on twin and triple engines. It is quite easy to gain or lose horsepower if your engine temperatures are not consistent between cylinders. These can be cut to shorten, OR to fine tune your wanted temp range.

Description	Temp Range	Part No.
Temperature Strips (5" Length) (3 pieces/pack)	77-212 degrees	TS104-212

FOUR STROKE
INTAKE SYSTEMS
ENGINE/GASKETS
EXHAUST
DRIVE LINE HANDLING
ELECTRICAL
WATERLINE /BILGE
STEERING & CONTROLS
BODY
ACCESSORIES
SERVICE TOOLS /HARDWARE
CHEMICAL



Wossner Pistons, Germany's finest aftermarket forged piston and rod manufacturer, now brings German quality to America. With over 25 years of custom piston and rod manufacturing, Wossner Pistons is deeply committed to bringing to market only the best and most accurately machined forged pistons and rods available.

Wossner Pistons commitment to quality stems from designing racing components for top European racing teams in all types of venues to supplying the weekend racer a hop-up high compression piston, or a big bore piston to take advantage of today's high revving high horsepower engines in both automotive and motorcycle applications.

With unsurpassed quality and a commitment, Wossner Pistons will always listen to the customer as this assures you will always receive the high quality forged CNC machined components you would expect from today's top European piston and rod manufacturer. Wossner Pistons believes in continued research and development so that the end user is guaranteed to receive the highest quality machined forged piston.

Wossner Pistons is a complete company that manufactures 2-stroke and 4-stroke PWC (personal watercraft), motorcycle, automotive, snowmobile forged pistons in various bore sizes and compression ratios. Wossner Pistons designs and manufactures all of our forgings in house.



Wossner Piston Features:

Wossner Pistons are Moly Teflon (Soft Coating) coated to allow for a tighter clearance when building an engine and making the break-in process easier. The coating is a "Soft" coating and when the pistons are removed from an engine the coating will show any wear patterns that have been created during the engine life.

Wossner Pistons are forged and then in most cases completely CNC machined both externally and internally to create the highest quality piston. They are often the lightest piston available from any piston company. With the pistons being lighter this will reduce wrist bearing and wrist pin fatigue and wear. The lighter weight will also allow a engine builder to bore the cylinder to a tighter clearance thus creating more horsepower.



Yamaha Model	Cylinders	Displacement	Bore Size	Over Size mm	Piston Part No.	Ring Set Part No.	Circlip Part No.
Super Jet 700 '93-12	2	701	81.00	Std.	6005DA	RDT8100	CW20
Wave Blaster 700 '93-96		710	81.50	+0.5	6005D050	RDT8150	CW20
Waver Raider 700 '94-98		718	82.00	+1.0	6005D100	RDT8200	CW20
Wave Runner III GP '94-97		726	82.50	+1.5	6005D150	RDT8250	CW20
Wave Runner PRO VXR700 '93-94		735	83.00	+2.0	6005D200	RDT8300	CW20
Wave Venture 700 '95-98		753	84.00	+3.0	6005D300	RDT8400	CW20
Wave Venture XL700 '02							
Wave Blaster 760 '96-97	2	754	84.00	Std.	6012DA	RDT8400	CW20
Wave Raider 760 '96-97		763	84.50	+0.5	6012D050	RDT8450	CW20
Wave Runner II 760 '96-97		771	85.00	+1.0	6012D100	RDT8500	CW20
Wave Venture 760 '97		780	85.50	+1.5	6012D150	RDT8550	CW20
		789	86.00	+2.0	6012D200	RDT8600	CW20
GP800R '98-05	3		79.90	Std.	6004DA	RDT7990	CW22
XL800 '00-01			79.91	+0.01	6004DB	RDT7990	CW22
XLT800 '02-04			79.92	+0.02	6004DC	RDT7990	CW22
GP1200R '00-03			79.93	+0.03	6004DD	RDT7990	CW22
XL1200 LTD '98-01			80.50	+0.6	6004D060	RDT8050	CW22
XLT1200 '01-05			81.00	+1.1	6004D110	RDT8100	CW22
Wave Runner 1100 '95-97	2		81.00	Std.	6005DA	RDT8100	CW20
Wave Venture 1100 '95-97			81.50	+0.5	6005D050	RDT8150	CW20
			82.00	+1.0	6005D100	RDT8200	CW20
			82.50	+1.5	6005D150	RDT8250	CW20
			83.00	+2.0	6005D200	RDT8300	CW20
			84.00	+3.0	6005D300	RDT8400	CW20
GP1300R '03-08	3		83.90	Std.	6003DA	RDT8400	CW22
			83.91	+0.01	6003DB	RDT8400	CW22
			83.92	+0.02	6003DC	RDT8400	CW22
1800c Four Cylinder '08-12	4		86.00	Std.	6505DA	860XTY	CW22
FX Cruiser SHO '08-11							
FX SHO '08-11							
FZR '09-12							
FZS '09-12 8.6:1 Compression							
VX1100 Sport '05-13	4		75.9	Std.	6509A	760XA5	CW17
VX1100 Cruiser '05-13							
VX1100 Deluxe '05-13							

Sea-Doo Model	Cylinders	Displacement	Bore Size	Over Size mm	Piston Part No.	Ring Set Part No.	Circlip Part No.
<u>XP / GTI / HX / SPX / GTS '95-05</u>	2	718	82.00	Std.	6002DA	RDT8200	CW20
<u>Challenger 718 '98</u>		726	82.50	+0.5	6002D050	RDT8250	CW20
<u>Challenger 718 '00-01</u>		735	83.00	+1.0	6002D100	RDT8300	CW20
<u>Explorer 718 '97&02</u>		744	83.50	+1.5	6002D150	RDT8350	CW20
<u>Speedster 718 '96-97</u>		754	84.00	+2.0	6002D200	RDT8400	CW20
<u>Speedster 718 SK '99</u>							
<u>Sportster 1800 '98-99</u> <u>Sportster 718 LT '02</u>							
<u>XP / SPX / GSX / GTX</u>	2	780	82.00	Std.	6001DA	RDT8200	CW20
<u>GTX-RFI / GTI / GSX-RFI780 '95-05</u>		785	82.10	+0.10	6001D010	RDT8210	CW20
		791	82.50	+0.5	6001D050	RDT8250	CW20
		801	83.00	+1.0	6001D100	RDT8300	CW20
		810	83.50	+1.5	6001D150	RDT8350	CW20
	820	84.00	+2.0	6001D200	RDT8400	CW20	
<u>GSX-LTD / XP-LTD</u>	2	951	88.00	Std.	6011DA	RDT8800	CW21
<u>GTX-LTD / LRV / RX950 '97-05</u>		960	88.50	+0.5	6011D050	RDT8850	CW21
<u>Sportster 950 LE '00-03</u>		971	89.00	+1.0	6011D100	RDT8900	CW21
<u>VSP950 LTD '99-03</u>		982	89.40	+1.4	6011D140	RDT8940	CW21
		993	90.00	+2.0	6011D200	RDT9000	CW21
	1017	91.00*	+3.0	6011D300	RDT9100	CW21	
<u>RXP215 '04-09</u> 9.5:1 Compression	3	1500	100.00	std.	6503DA	1000XTY	CW23
<u>RXP-X255 '08-10</u>			100.50	+0.5	6503D050	1005XTY	CW23
<u>RXT 255/260 '05-10</u>							
<u>RXT-X 255/260 '08-10</u>							

*Cylinder sleeving and crankcase cleanup required for 91mm bore

Kawasaki Model	Cylinders	Displacement	Bore Size	Over Size mm	Piston Part No.	Ring Set Part No.	Circlip Part No.
<u>JS750 SS '95-96</u>	3	743	80.00	Std.	6006DA	RDT8000	CW20
<u>Supersport '93-95</u>		752	80.50	+0.5	6006D050	RDT8050	CW20
<u>750SX '92-95</u>		760	81.00	+1.0	6006D100	RDT8100	CW20
<u>ST '94-95</u>		771	81.50	+1.5	6006D150	RDT8150	CW20
<u>XIR 1994</u>		779	82.00	+2.0	6006D200	RDT8200	CW20
		795	83.00	+3.0	6006D300	RDT8300	CW20
		840	85.00	+5.0	6006D500	RDT8500	CW20
		849	85.50	+5.5	6006D550	RDT8550	CW20
<u>SX-R800 '03-12</u>	2	782	82.00	Std.	6010DA	RDT8200	CW22
		791	82.50	+0.5	6010D050	RDT8250	CW22
		800	82.96	+0.96	6010D096	RDT8300	CW22
<u>JS900 '95-96</u>	3	891	73.00	Std.	6009DA	RDT7300	CW20
<u>ZXI900 '95-97</u>		903	73.50	+0.5	6009D050	RDT7350	CW20
<u>STX900 '97-06</u>		915	74.00	+1.0	6009D100	RDT7400	CW20
<u>STS900 '01-02</u>		928	74.50	+1.5	6009D150	RDT7450	CW20
<u>ZXI1100 '96-03</u>	3	1071	80.00	Std.	6007DA	RDT8000	CW22
<u>STX1100 '97-99</u>		1083	80.50	+0.5	6007D050	RDT8050	CW22
<u>STX1100 '00-03</u>		1097	81.00	+1.0	6007D100	RDT8100	CW22
<u>Ultra130 '01-04</u>		1106	81.50	+1.5	6007D150	RDT8150	CW22
		1125	82.00	+2.0	6007D200	RDT8200	CW22
		1151	83.00	+3.0	6007D300	RDT8300	CW22
		1165	83.50	+3.5	6007D350	RDT8350	CW22
		1179	84.00	+4.0	6007D400	RDT8400	CW22
		1193	84.50**	+4.5	6007D450	RDT8450	CW22
		1207	85.00**	+5.0	6007D500	RDT8500	CW22
<u>Ultra150 (1200) '95-05</u>	3	1176	80.00	Std.	6013DA	RDT8000	CW24
		1191	80.50	+0.5	6013D050	RDT8050	CW24
		1205	81.00	+1.0	6013D100	RDT8100	CW24
<u>STX-12F '03-07</u>	4	1199	82.93	Std.	6508DA	830XDS	CW21
<u>STX-15F '04-11</u>	4	1498	82.93	Std.	6507DA	830XDS	CW21
<u>Ultra250X '07-08</u> 7.8:1 Compression	4	1498	82.90	Std.	6511DA	830XSY	CW21
<u>Ultra260X/LX '09-10</u> 8.4:1 Comp.	4	1498	82.93	Std.	6506DA	830XTY	CW21
<u>Ultra300X/LX 2011</u> 8.4:1 Comp.	4	1498	82.90	Std.	6510DA	830XSY	CW21

**Crankcase cleanup and Cylinder sleeving required for 83mm thru 85.00mm bore

FOUR STROKE
INTAKE SYSTEMS
ENGINE/ GASKETS
EXHAUST
DRIVE LINE HANDLING
ELECTRICAL
WATERLINE /BILGE
STEERING & CONTROLS
BODY
ACCESSORIES
SERVICE TOOLS /HARDWARE
CHEMICAL



PRO-X PISTON KITS

Pro-X Piston Kits are manufactured in Japan and are designed to be an O.E.M. replacement. The aluminum alloy used in the manufacturing of Pro-X pistons maintains or exceeds the factory specifications. Additional oversizes are available in .010 increments up to .080 (2.00 mm).

To order Pro-X rings, change the piston part number prefix from 01 to 02 (For example: piston part #01.5506.00 has ring part #02.5506.00). Most Pro-X rings are special order only.



SEA-DOO	Std. Bore	STD	.010	.020	.030	.040	.060	.080	Top End Bearings
		STD	.25mm	.50mm	.75mm	1mm	1.5mm	2mm	
580 All thru 1996	76.00	01.5506.000				01.5506.100			50-4185
720 HX, XP, GTS, GS SPX, GTI, GSI 1995-02	82.00	01.5508.000	01.5508.025	01.5508.050	01.5508.075	01.5508.100	01.5508.150		50-4184
800 XP, GSX, GTI, RFI SPX 1995-02	82.00	01.5511.000	01.5510.025	01.5510.050	01.5510.075	01.5510.100	01.5510.150		50.4184
951 XPL, GSXL, GTXL RX, LRV 1997-07	88.00	01.5515.000	01.5515.025	01.5515.050	01.5515.075	01.5515.100	01.5515.150		01242
4-Tec RXP, RXT, RXP-X 8.4:1 Compression	100.00	01.5594.000		01.5594.050		01.5594.100			

YAMAHA	Std. Bore	STD	.010	.020	.030	.040	.060	.080	Top End Bearings
		STD	.25mm	.50mm	.75mm	1mm	1.5mm	2mm	
701 All thru 2013	81.00	01.2510.000	01.2510.025	01.2510.050	01.2510.075	01.2510.100	01.2510.150	01.2510.200	50-3483
760 All thru 1998	84.00	01.2514.000	01.2514.025	01.2514.050	01.2514.075	01.2514.100	01.2514.150		50-3483
1200/GP1200 All thru 1998	84.00	01.2514.000	01.2514.025	01.2514.050	01.2514.075	01.2514.100	01.2514.150		50-3483
800 All thru 2002	79.90	01.2518.A		01.2518.050		01.2518.100			01343
GP1200 R 2000-02	79.91	01.2518.B		(80.50mm)		(81.00mm)			
XL1200 LTD 1998-00	79.92	01.2518.C							
XLT1200 2001-02	79.93	01.2518.D							
GP1300 R 2003-07 (Nikasil Piston Size)	83.90	01.2520.A		01.2519.050		01.2519.100			
	83.91	01.2520.B		(84.50mm)		(85.00mm)			
	83.92	01.2520.C							

	Std. Bore	STD
FX140 (2003-06) FX140 Cruiser (Nikasil Piston Size)	75.00	01.2523.100

*Replating or cylinder sleeving required for oversizes

	Std. Bore	STD
VX 110 (2005-12) (Nikasil Piston Size)	75.95 75.96 75.97	01.2905.A 01.2905.B 01.2905.C

11.4:1 Compression

	Std. Bore	STD
FX SHO (2008-14) FX Cruiser SHO (2008-14) FZR (2009-13) FZS (2009-13) (Nikasil Piston Size)	85.95 85.96 85.97	01.2909.A 01.2909.B 01.2909.C

8.6:1 Compression

KAWASAKI	Std. Bore	STD	.010	.020	.030	.040	.060	.080	Top End Bearings
		STD	.25mm	.50mm	.75mm	1mm	1.5mm	2mm	
JT750 SS, SX, Xi 1993-97	80.00	01.4510.000				01.4510.100			50-3302
JT750 ZXi, SXi 1995-98	80.00	01.4515.000		01.4515.050		01.4515.100	01.4515.150		50-3304
800 SX-R 2003-12	82.00	01.4523.000	01.4523.025	01.4523.050		01.4523.100			50-3304
JS900 ZXi, STX 1995-06	73.00	01.4520.000	01.4520.025				01.4520.150		50-3304
JS1100 ZXi 1996-98	80.00	01.4515.000		01.4515.050		01.4515.100	01.4515.150		50-3304

	Size	Piston Kit	Ring Set
STX-15F (2004-14)	82.95	01.4554.A	02.4554
STX (2009-10)	82.96	01.4554.B	02.4554
Ultra LX (2007-14) (Nikasil Piston Size)	82.97	01.4554.C	02.4554

10.6:1 Compression

	Size	Piston Kit	Ring Set
Ultra 260X (2009-10)	82.95	01.4559.A	02.4559
Ultra 260LX (2009-10) (Nikasil Piston Size)	82.96 82.97	01.4559.B 01.4559.C	02.4559

7.8:1 Compression

	Size	Piston Kit	Ring Set
Ultra 300X (2011-13)	82.95	01.4561.A	02.4559
Ultra 300LX (2011-13) (Nikasil Piston Size)	82.96 82.97	01.4561.B 01.4561.C	02.4559

8.4:1 Compression

PRO MARINE OEM REPLACEMENT CAST PISTONS

Pro Marine pistons are a hypereutectic cast piston with a high silicone content and feature a black Teflon coating for engine break in. Pro Marine pistons are manufactured in Argentina. Each piston kit comes complete with a piston, ring set, wrist pin and circlips. These pistons are recommended for recreational PWC engines and have not been tested in race applications at the time of this catalog printing.



SEA-DOO	Std. Bore	STD	.010	.020	.030	.040	.060	.080	Top End Bearings
		STD	.25mm	.50mm	.75mm	1mm	1.5mm	2mm	
720 HX, XP, GTS, GS SPX, GTI, GSI 1995-02	82.00	8040P	8041P	8042P	8043P	8044P	8046P		50-4184
800 XP, GSX, GTI, RFI SPX 1995-02	82.00	8050P	8051P	8052P	8053P	8054P	8056P		50.4184
951 XPL, GSXL, GTXL RX, LRV 1997-07	88.00	8060P		8062P	8063P	8064P	8066P		01242

YAMAHA	Std. Bore	STD	.010	.020	.030	.040	.060	.080	Top End Bearings
		STD	.25mm	.50mm	.75mm	1mm	1.5mm	2mm	
701 All thru 2013	81.00	7090P	7091P	7092P	7093P	7094P	7096P		50-3483
760 All thru 1998	84.00	7110P	7111P	7112P	7113P	7114P	7116P		50-3483
1100 All	84.00	7090P	7091P	7092P	7093P	7094P	7096P		
1200/GP1200 All thru 1998	84.00	7110P	7111P	7112P	7113P	7114P	7116P		50-3483
800 All thru 2002 GP1200 R 2000-02 XL1200 LTD 1998-00 XLT1200 2001-02	80.00	7170P		7172P		7174P			01343

KAWASAKI	Std. Bore	STD	.010	.020	.030	.040	.060	.080	Top End Bearings
		STD	.25mm	.50mm	.75mm	1mm	1.5mm	2mm	
JT750 ZXI, SXi 1995-98 Big Wrist Pin (22mm)	80.00	4490P		4492P		4494P	4496P		50-3304



RHAAS MOTOR MOUNTS



Yamaha SuperJet
Motor Mount
Part No. SJBILLET



Yamaha Blaster FX1
Motor Mount
Part No. BLASTERBILLET



Yamaha 4-Stroke & GPR
Motor Mount
Part No. YAM4STRMOUNT



Polaris Octane
Motor Mount
Part No. BILLETCTANE



Kawasaki 440/550
Motor Mount
Part No. 440550MOUNT



Kawasaki 650/750/800
Motor Mount
Part No. KAWIBILLET



Kawasaki STX
Motor Mount
Part No. STXMOUNT

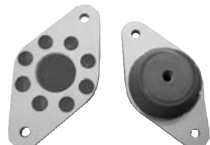

Kawasaki Ultra 150
Front Motor Mount
Part No. 150FRONTMOUNT



Sea-Doo 580/650/720
Motor Mount
Part No. SD580650720MOUNT



Sea-Doo 951
Front Motor Mount
Part No. SD951FRONT



Sea-Doo 800/951
Rear Motor Mount
Part No. 800-951REARMOUNT



Sea-Doo 800
Front Motor Mount
Part No. SD800FRONT



Sea-Doo 4-Tec
Rear Motor Mount
Part No. SD4TECREAR



Sea-Doo 4-Tec
Front Motor Mount
Part No. SD4TECFRONT

FOUR
STROKE
INTAKE
SYSTEMS
ENGINE/
GASKETS
EXHAUST
DRIVE LINE
HANDLING
ELECTRICAL
WATERLINE
/BILGE
STEERING
& CONTROLS
BODY
ACCESSORIES
SERVICE TOOLS
/HARDWARE
CHEMICAL

TOP END ENGINE REBUILD KITS

Include pistons, rings, pins, clips, needle bearings, gaskets for head, base, intake and exhaust. Available in original and platinum series.

ORIGINAL SERIES

MODEL	YEAR	SIZE	PART NO.
SEA-DOO			
580 (yellow)	88-91	Std.	010-815-20
		.25mm	010-815-21
		.5mm	010-815-22
		.75mm	010-815-23
		1mm	010-815-24
580 (white)	92 & up	Std.	010-815-10
		.25mm	010-815-11
		.5mm	010-815-12
		.75mm	010-815-13
		1mm	010-815-14
650	93	Std.	010-816-20
		.25mm	010-816-21
		.5mm	010-816-22
		.75mm	010-816-23
		1mm	010-816-24
650	94 & up	Std.	010-816-10
		.25mm	010-816-11
		.5mm	010-816-12
		.75mm	010-816-13
		1mm	010-816-14
720	All	Std.	010-817-10
		.25mm	010-817-11
		.5mm	010-817-12
		.75mm	010-817-13
		1mm	010-817-14
800	All	Std.	010-818-10
		.25mm	010-818-11
		.5mm	010-818-12
		.75mm	010-818-13
		1mm	010-818-14
800 Rfi	All	Std.	010-808-10
		.25mm	010-808-11
		.5mm	010-808-12
		.75mm	010-808-13
		1mm	010-808-14
951 Carb. Motor	All	Std.	010-819-10
		.25mm	010-819-11
		.5mm	010-819-12
		.75mm	010-819-13
		1mm	010-819-14
951 Di	All	Std.	010-809-10
		.25mm	010-809-11
		.5mm	010-809-12
		.75mm	010-809-13
		1mm	010-809-14
Gtx 4-Tec Ltd. RXP, RXT Supercharged 215 / 255 / 260	05-13	Std.	010-862-10
		.5mm	010-862-12
		.75mm	010-862-13
MODEL	YEAR	SIZE	PART NO.
YAMAHA			
500	All	Std.	010-801-10
		.25mm	010-801-11
		.5mm	010-801-12
		.75mm	010-801-13
		1mm	010-801-14
650 (6M6)	All	Std.	010-802-10
		.25mm	010-802-11
		.5mm	010-802-12
		.75mm	010-802-13
		1mm	010-802-14

MODEL	YEAR	SIZE	PART NO.
YAMAHA CONTINUED			
701 (61X)		Std.	010-825-10
		.25mm	010-825-11
		.5mm	010-825-12
		.75mm	010-825-13
		1mm	010-825-14
701 (62T)		Std.	010-827-10
		.25mm	010-827-11
		.5mm	010-827-12
		.75mm	010-827-13
		1mm	010-827-14
760 (64X)	All	Std.	010-826-10
		.25mm	010-826-11
		.50mm	010-826-12
		.75mm	010-826-13
		1mm	010-826-14
1100 2 stroke	All	Std.	010-827-20
		.25mm	010-827-21
		.5mm	010-827-22
		.75mm	010-827-23
		1mm	010-827-24
1200 no power valves	97-99	Std.	010-826-20
		.25mm	010-826-21
		.5mm	010-826-22
		.75mm	010-826-23
		1mm	010-826-24
FX 140	02-06	Std.	010-870-10
		.25mm	010-870-11
		.5mm	010-870-12
FX 140 HO	02-06	Std.	010-871-10
		.25mm	010-871-11
VX 1100	05-12	Std.	010-872-10
		.25mm	010-872-11
		.5mm	010-872-12
MODEL	YEAR	SIZE	PART NO.
KAWASAKI			
550 SX	82-90	Std.	010-812-10
		.25mm	010-812-11
		.5mm	010-812-12
		.75mm	010-812-13
		1mm	010-812-14
650 All	91-96	Std.	010-810-10
		0.25mm	010-810-11
		0.50mm	010-810-12
		0.75mm	010-810-13
		1.00mm	010-810-14
750 SS	92-95	Std.	010-820-10
750 SSXi	93-95	.25mm	010-820-11
750 ST	94-95	.5mm	010-820-12
750 SX	92-94	.75mm	010-820-13
750 XiR, SXi	94	1mm	010-820-14
750 SS, SSXi	96-97	Std.	010-821-10
750 STS	95-97	.25mm	010-821-11
750 STX	98	.5mm	010-821-12
750 SXi	95-96	.75mm	010-821-13
750 ZXi	95-97	1mm	010-821-14
800	All	Std.	010-843-10
		.25mm	010-843-11
		.5mm	010-843-12
		.75mm	010-843-13
		1mm	010-843-14

MODEL	YEAR	SIZE	PART NO.
KAWASAKI CONTINUED			
900 except STX 97-06	All	Std.	010-840-10
		.25mm	010-840-11
		.5mm	010-840-12
		.75mm	010-840-13
		1mm	010-840-14
900 STX 97-98	All	Std.	010-840-20
		.25mm	010-840-21
		.5mm	010-840-22
		.75mm	010-840-23
		1mm	010-840-24
1100 STX	97-99	Std.	010-821-20
1100 ZXi	96-03	.25mm	010-821-21
		.5mm	010-821-22
		.75mm	010-821-23
		1mm	010-821-24
1100 STX Di	00-03	Std.	010-842-10
1100 Ultra-130 Di	01-04	.25mm	010-842-11
		.5mm	010-842-12
		.75mm	010-842-13
		1mm	010-842-14
1200 Ultra 150	99-05	Std.	010-841-10
		.25mm	010-841-11
		.5mm	010-841-12
		.75mm	010-841-13
1200 STX-R	02-05	1mm	010-841-14
		Std.	010-844-10
		.25mm	010-844-11
		.50mm	010-844-12
STX-12F	03-07	Std.	010-844-10
		.25mm	010-844-11
		.50mm	010-844-12
STX-15F	04-12	Std.	010-845-10
		.25mm	010-845-11
		.50mm	010-845-12
MODEL	YEAR	SIZE	PART NO.
TIGER SHARK			
640	All	Std.	010-850-10
		.25mm	010-850-11
		.5mm	010-850-12
		.75mm	010-850-13
		1mm	010-850-14
770	All	Std.	010-851-10
		.25mm	010-851-11
		.5mm	010-851-12
		.75mm	010-851-13
		1mm	010-851-14
MODEL	YEAR	SIZE	PART NO.
POLARIS			
650	All	Std.	010-831-10
		.25mm	010-831-11
		.5mm	010-831-12
		.75mm	010-831-13
		1mm	010-831-14
700	All	Std.	010-832-10
		.25mm	010-832-11
		.5mm	010-832-12
		.75mm	010-832-13
		1mm	010-832-14
750	All	Std.	010-830-10
		.25mm	010-830-11
		.5mm	010-830-12
		.75mm	010-830-13
		1mm	010-830-14

HOT PRODUCTS CONNECTING RODS

Heavy duty replacement rods are used in many racing applications because of proven reliability. Kits are complete with top and bottom roller bearings, pin and shims. Made in Japan.

Sea-Doo	Part No.
580	50-3520
720 (PTO)	50-3522
720 (MAG)	50-3523
785	50-3524
951	50-3525

Yamaha	Part No.
500	50-3480
650/701/760/1100/1200 (97-98)	50-3490
GP800R/XL800/GP1200R/XL1200*	50-3495

*Crank pins are not included in kit 50-3495

Kawasaki	Part No.
450/550 All	50-3120
650 All	50-3270



PERSONAL WATERCRAFT CONNECTING ROD DIMENSIONS

Watercraft Model	CENTER TO CENTER MM	SMALL END BORE MM	BIG END BORE MM	SMALL END WIDTH MM	BIG END WIDTH MM	PIN DIAMETER MM	PIN LENGTH MM	SMALL END BEARING MM	BIG END BEARING MM	WASHER THICKNESS MM
KAWASAKI										
JS 440/550	110	20	30.6	18	15	24.6	49	16X20X23	24.6X30.6X15	1
JS/JF 650	133	22	32	22	20	24	59	18X22X24	24X32X20	1
JS 750 (93-96) 20mm wrist pin	133	25	34	22	20	26	59	20X25X25	26X34X20	1
JS 750 (95-00) 22mm wrist pin	133	27	36	22	20	28	58	22X27X25	28X36X20	1
JS 900 ZXI	133	25	34	22	20	26	59	20X25X25	26X34X20	1
JS 1100 ZXI, SXI (95-00)	135	27	34	22	20	26	59	22X27X25	26X34X20	1
Ultra 150	140	29	40	22	20	32	62	24X29x25	32x40x20	1
POLARIS										
650/750/780 SL MAG/center	120	23	32.3	16	16	24.3	51	18X23X22	24.3X32.3X16	1
650/750/780 SL PTO	120	23	32.3	16	16	24.3	54	18X23X22	24.3X32.3X16	1
700/900/1050	136	25	35	16	16	28	60	20X25X22	28X35X16	1
Sea-Doo										
580 thru (96)	125	22	31	17	17	24	52	18X22X22	24X31X17	1
650 thru (97)	125	25	31	17	17	24	52	20X25X22	24X31X17	1
720 XP, HX MAG (95-00)	125	24	33	18	18	26	53	20X24X22	26X33X18	1
720 XP, HX PTO (95-00)	125	24	33	18	18	26	55	20X24X24	26X33X18	1
785 XP RAVE (all)	140	24	35	18	18	28	55	20X24X23	28X35X18	1
951 RAVE (98-00)	140	25	36	20	20	28	57	21X25X24	28X36X20	1
YAMAHA										
650/901/760/1100 (all)	125	25	32	20	20	25	60	20X25X24	25X32X20	1
GP800, GP1200R	135	27	34	21	21	27	69	22x27x23	29x34x21	1.5



A.

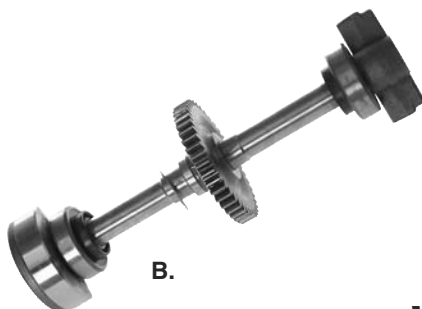

B.



WSM COUNTER BALANCE SHAFT ASSEMBLIES



C.



D.

Description	Part No.
A. Sea-Doo 800 All	010-4018
B. Sea-Doo 951 Carburetor Model	010-4019
C. Balance Shaft Cone 800/951	010-300
D. Oil Seal (2 required, sold individually)	009-786

HOT RODS CONNECTING RODS



Hot Rods are double forged to improve grain flow and maintain dimensional consistency.



Sea-Doo	Part No.
580 1990-96	HR8166
650 1997	HR8117
720 1995-02 MAG	HR8116
720 1995-02 PTO	HR8168
785	HR8123
951 1998-05	HR8601
951 Direct Injection	HR8628

Polaris	Part No.
700/900/1050	HR8122

Yamaha	Part No.
650/701/760/1100/1200 (97-98)	HR8169
GP800/GP1200R	HR8606

Kawasaki	Part No.
750 (92-95), 900 ZXI	HR8114
750 (96-02), 800 03-07	HR8131
1100ZXI (95-00),STX	HR8138
Ultra 150 (99-05), STX R (02-05)	HR8607



CRANK SHAFT REPLACEMENT BEARINGS



Sea-Doo	FRONT MAG. #1	FRONT MAG. #2	INNER #1	INNER #2	REAR PTO#1	REAR PTO#2
580 87-94	6206NR	6206NR	6305NR	6206NR	6207NC4	6207NC4
580 95-96	6206NC4	6206NC4	6305NR	6206NR	6207NC4	6207NC4
650 93	6206NR	6206NR	6206NC4	6206NC4	6207NC4	6207NC4
650 94-96	6206NC4	6206NC4	6206NC4	6206NC4	6207NC4	6207NC4
720 all	6206NC4	6206NC4	6206NC4	6206NC4	6207NC4	6207NC4
800 all	6207NC4	6207NC4	6207NC4	6207NC4	6306NR	6207NC4
951 all	6208NC4	6208NC4	6306NC4 (NOT AVAILABLE)	6208NC4	6208NC4	6208NC4

Yamaha	FRONT MAG. #1	FRONT MAG. #2	INNER #1	INNER #2	REAR PTO#1	REAR PTO#2
650/701/760	010-204		6207YR	6207YR	ADR 701-PTO (6307NC4)	
1100/1200	010-204	6207YR	6207YR	6207YR	6207YR	83B727

Kawasaki	FRONT MAG. #1	FRONT MAG. #2	INNER #1	INNER #2	REAR PTO#1	REAR PTO#2
440/550	6206NR		6305N	6305N	6206N	
650/750	6306C3		6306C3	6306NR	6306C3	
900/1100/Ultra	5207-1LT		6207NLT	83A844A (3)	83A948	

Polaris	FRONT MAG. #1	FRONT MAG. #2	INNER #1	INNER #2	REAR PTO#1	REAR PTO#2
650/701/780	6207NC4	6207NC4	6207NC4(2)	6307NR		
700/900/1050	6207NC4	6207NC4	6207NC4	6207NC4	6207NC4	6207NC4

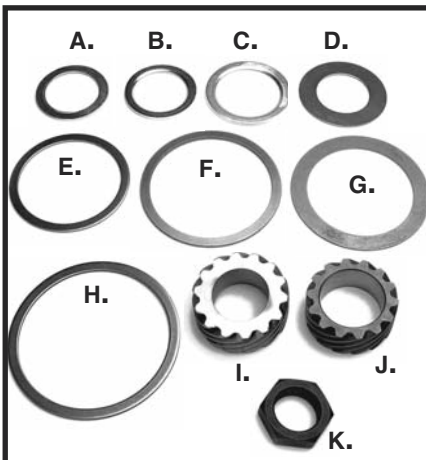

CRANKSHAFT PARTS FOR SEA-DOO

Descriptions	Models	OEM No.	Part No.
A. Distance Ring	720 Mag side – 1.5mm thick	290-827-447	010-474
B. Distance Ring	580/650 Mag side – 2mm thick	290-827-440	010-472
C. Distance Ring	580/650/720 Pto side		
	800 Mat & Pto – 2mm thick	290-827-760	010-473
D. Flat Bearing Washer	580/650 (Small)	420-827-715	010-475
E. Retainer Shim	720 (Small)	420-827-050	010-476
F. Retainer Shim	720 (Medium)	420-827-050	010-477
G. PTO Seal Retaining Ring	580/650/720/800 (Large)	420-827-715	010-479
H. Thrust Washer	951		010-470
I. Crank Center Gear	580		010-471-01
J. Crank Center Gear	650/720/800		010-471
K. Flywheel Nut	All Models	420-842-230	010-480

FOUR STROKE
INTAKE SYSTEMS
ENGINE/GASKETS
EXHAUST
DRIVE LINE HANDLING
ELECTRICAL
WATERLINE /BILGE
STEERING & CONTROLS
BODY
ACCESSORIES SERVICE TOOLS
/HARDWARE
CHEMICAL



Hot Products removes the Hot Rods wrist pin bearings from all Hot Rod crankshafts and upgrades them to Japanese wrist pin bearings to insure the highest quality part is supplied.

HOT RODS NEW COMPLETE CRANKSHAFT ASSEMBLIES

All new assembly. Crankshafts are sold complete with Hot Rods Connecting rods, main bearings and inner crankshaft webs. Trued to within .001. Crankshafts are completely rebuildable.

Sea-Doo	Crank Assy.
580 All	HR4008
720 All	HR4009
785 (1996-04) (will not fit fuel injection models)	HR4010
951 All Carburetor Models	HR4051
951 All Injection Models	HR4052

Yamaha	Crank Assy.
650/701/760 All	HR4003
800 GPR	HR4072
1100 Triple (63M)	HR4104
1200 Triple (65U) (No mag end bearing)	HR4004
1200 Triple (66V), 1300 Triple (60T)	HR4069

Kawasaki	Crank Assy.
750 96-02, 800 SX-R (03-12)	HR4061
900STX (97-06)	HR4088
1100ZXI (96-03)	HR4087



CRANKSHAFT OIL SEAL KIT

Hot Products has researched and tested these crank case seal kits to ensure the highest of quality and durable seals on the market. These seals are a direct replacements for the OEM seals. Why risk an engine failure or a short seal life with low cost seals when Hot Products has these seals in stock and ready for installation in your customers engine.



WSM NEW COMPLETE YAMAHA CRANKSHAFT ASSEMBLY

Yamaha	Part No.
650/701/760 All	010-1025WSM



CRANKSHAFT WEBS

OEM Kawasaki 650/750 and Yamaha cranks are non-rebuildable. In order to rebuild these crankshafts the crankshaft webs must be replaced.

Yamaha	Part No.
650/701/760/1100/1200	HR201

Kawasaki	Part No.
650	HR203
750ZXI/SXI (28mm Crank Pin)	HR205

*Web Kit contains 2 webs without crank pin.

		NEW		
Sea-Doo	Pro-X	Hot Products (ARS)	Gasket Technology	
580	42.5506	51-0068-ARS	-	
650/720	42.5507	-	-	
785	42.5510	-	-	
951 Two inner seals included*	42.5515	-	-	
* Inner seals are not made by ARS				
Yamaha	Pro-X	Hot Products (ARS)	Gasket Technology	
500 87-90	-	51-0048-ARS	-	
650/701/760	42.2510	51-0054-ARS	-	
1100/1200				
800	42.2518	-	-	
GP1200R/ GP1300R	42.2520	-	-	
Kawasaki	Pro-X	Hot Products (ARS)	Gasket Technology	
440 73-80 (Full Circle)	-	51-0014 (NOK)	-	
440 81-91/ 550JS/550SX	-	-	5335K	
650/750/800	42.4505	51-0027-ARS	-	
900/1100	42.4519	51-0029-ARS	-	



HOT PRODUCTS GASKET SETS



Sea-Doo	Top	Complete
580 -91 Yellow Eng.SP/XP/GT	6400	6425
580 92+ White Eng.SP/SPI/XP/GTS	6440	6465
650 GTX/XP/XPI/SPX	6480	6500
720 SPX/GT/HX	6600	6610
785 XP/GSX/GTX	6620	6640
800 DI	6855	6860
951 97 GSX LTD White Eng.	6825	6830
951 98 XP LTD, GSX LTD Silver Eng	6840	6842
951 DI.	6875	6880
4-Tec	—	6990K
4-Tec	007-626-01**	007-626**

Polaris	Top	Complete
650	4200	4210
750	4220	4230
700 Hurricane, Virage, Freedom	4375	4378
Octane 777	—	4860
780	4235	4240
785/Pro	Discontinued	Discontinued
900	4380	4383
1050	4385	4390
1200 Genesis	4394	4395

Tiger Shark	Top	Complete
639	3100	3110
644	3100	3120

Hot Products gasket sets consist of superior quality gaskets for engine rebuilders and the hi-performance personal watercraft markets. All Hot Products Gasket Sets are "Made in the USA." Hot Products offers top end and complete gaskets sets. **Note Hot Products Complete Gasket sets do not include crankshaft oil seals.**

Yamaha	Top	Complete
WJ/WR500	—	51-4803
SJ/WRIII/VXR650 (90-93)	2600	2650
LX650 (90-93)	—	51-5703
701SJ-95, BLST-95, 701W/Raider 96+	2700	2750
701SJ 96+, BLST 96+	2550	2555
701W/RDR 94-95/Venture 95+	2950	2980
760W/RDR 96+/BLST II 96+/XL760	2990	2992
800 GP 98+	3520	3530
1100Raider/Venture	4520	4530
1200 GP, XL1200	4680	4685
GP1200R, XL1200LTD	3730	3740
GP1300R	3800	3810
FX140 (02-06)	007-670-01**	007-670**
FX140 HO (High Output) (04-08)*	007-671-01**	007-671**
VX110 (05-08)*	007-672-01**	007-672**
FX SHO/FZS/FZR (08-10)*	007-673-01**	007-673**
FX SHO/FZS/FZR (11-13)*	007-674-01**	007-674**

Kawasaki	Top	Complete
440 77-80	—	5350
440 81-92	—	51-1503
550 82-85	5550	5560
550 86-90	5570	5580
550SX 91-95	—	51-2403
650 All	—	5940
650 X2, TS	—	5960
750 All/800SXR	7200	—
750 SX/SXI/SXI Pro	7200	7210
750 SS/XI	7200	7220
750 SS 92-93	7200	7240
750 XIR	7200	7230
750 95 STS	7200	7225
750 ZXI 95+	7200	7245
800 SXR 03-12	7300	7310
900 ZXI 95+	7500	7520
1100 ZXI 96-98	7670	7680
Ultra 150 99+	7830	7835
1200 STX-F (12F) 03-07	—	007-645-05
1500 STX-F (15F) 04-08	—	007-645-05
Ultra 250/260 (04-10)	007-646-01**	007-646**
Ultra 300	007-646-03**	007-646-02**

**** Indicates Specific Gasket Sets Manufactured by WSM**

INDIVIDUAL GASKETS FOR SEA-DOO

* Denotes when the gasket is included in the Top End Gasket Set.

580 PRE '92 SP/XP/GT (Yellow Engine)

YELLOW ENGINE	OEM No.	Part No.
Top Kit	Yellow Engine	6400
Complete Kit	Yellow Engine	6425
Head Cover O-Ring	290-950-050	6200*
Spark Plug O-Ring (2 required)	290-430-782	6220*
Cylinder O-Ring (2 required)	290-850-540	6170*
Water Jacket O-Ring (2 required)	290-850-040	6230*
Base Gasket	290-931-160	6000*
Carb Gasket 38mm (2 required)	290-842-040	6100*
Exhaust Gasket (2 required)	290-850-630	6050*
Headpipe Gasket	290-950-250	6140*
Starter Gasket	290-950-905	6120
Water Dist	290-831-612	6110
Water Mani O-Ring (2 required)	290-430-460	6240*
Flywheel Housing	290-850-600	6125
Rotary Valve Shaft O-Ring	290-831-500	6260
Rotary Valve Cover O-Ring	290-831-360	6250
Manifold O-Ring (2 carb)	290-831-705	6270
Manifold O-Ring (1 carb)	290-850-160	6275
Flywheel Cover O-Ring	290-950-130	6280

580 '92+ SP/SPI/XP/GTS (WHITE ENGINE)

WHITE ENGINE	OEM No.	Part No.
Top Kit	White Engine	6440
Complete Kit	White Engine	6465
Head Cover O-Ring	290-950-360	6205*
Spark Plug O-Ring (2 required)	290-430-782	6220*
Cylinder O-Ring (2 required)	293-300-026	6170*
Water Jacket O-Ring (2 required)	290-850-040	6230*
Base Gasket	290-931-161	6020.3*
Carb Gasket 38mm (2 required)	290-850-373	6100*
Carb Gasket 39mm (2 required)	270-000-114	6105*
Exhaust Gasket (2 required)	290-850-635	6060*
Headpipe Gasket	290-950-251	6150*
Starter O-Ring	278-000-694	6152
Flywheel Housing	290-850-605	6130
Rotary Valve Shaft O-Ring	293-300-023	6250
Rotary Valve Cover O-Ring	293-300-024	6260
Manifold O-Ring (2 carb)	290-831-705	6270
Flywheel Cover O-Ring	290-831-555	6278

FOUR STROKE
INTAKE SYSTEMS
ENGINE/GASKETS
EXHAUST
DRIVE LINE HANDLING
ELECTRICAL
WATERLINE /BILGE
STEERING & CONTROLS
BODY
ACCESSORIES
SERVICE TOOLS
HARDWARE
CHEMICAL

SEA-DOO INDIVIDUAL GASKETS

951 97+ GSX LTD, XP LTD

650 GTX/XP/XPI/SPX

	OEM No.	Part No.
Top Kit		6480
Complete Kit		6500
Head Cover O-Ring	290-950-320	6210*
Spark Plug O-Ring (2 required)	290-430-782	6220*
Cylinder O-Ring (2 required)	290-931-220	6180*
Water Jacket O-Ring (2 required)	290-850-045	6235*
Base Gasket (.012/0.3mm)	290-931-161	6020.3
Base Gasket (.017/0.4mm)	290-931-162	6020.4
Base Gasket (.020/0.5mm)	290-931-163	6020.5*
Base Gasket (.024/0.6mm)	290-931-164	6020.6
Base Gasket (.030/0.8mm)	290-931-165	6020.8
Carb Gasket 38mm (2 required)	290-850-373	6100*
Exhaust Gasket (2 required)	290-850-637	6080*
Headpipe Gasket	290-950-251	6150*
Starter O-Ring	278-000-694	6152
Flywheel Housing	290-850-605	6130
Rotary Valve Cover O-Ring	293-300-023	6250
Rotary Valve O-Ring	293-300-024	6260
Manifold O-Ring (2 carb)	290-831-705	6270
Flywheel Cover O-ring	290-831-555	6278

720 SPX/GTI/HX/GTS/GS

	OEM No.	Part No.
Top Kit		6600
Complete Kit		6610
Head Cover O-Ring	290-950-360	6205*
Spark Plug O-Ring (2 required)	290-430-782	6220*
Cylinder O-Ring (2 required)	290-931-410	6185*
Water Jacket O-Ring (2 required)	290-850-045	6235*
Base Gasket (.012/0.3mm)	290-931-400	6025.3
Base Gasket (.017/0.4mm)	290-931-401	6025.4
Base Gasket (.020/0.5mm)	290-931-402	6025.5*
Base Gasket (.024/0.6mm)	290-931-403	6025.6
Base Gasket (.030/0.8mm)	290-931-404	6025.8
Carb Gasket 41mm (2 required)	293-250-042	6107*
Exhaust Gasket (2 required)	290-850-637	6080*
Headpipe Gasket	290-950-251	6150*
Starter O-Ring	278-000-694	6152
Flywheel Housing	290-850-605	6130
Rotary Valve Cover O-Ring	293-300-023	6250
Rotary Valve Shaft O-Ring	293-300-024	6260
Flywheel Cover O-ring	290-831-555	6278

785 XP/GSX/GTX/SPX

	OEM No.	Part No.
Top Kit		6620
Complete Kit		6640
Head Cover O-Ring	290-831-550	6612*
Spark Plug O-Ring (2 required)	290-430-782	6220*
Cylinder O-Ring (2 required)	290-931-410	6185*
Water Jacket O-Ring (2 required)	290-931-420	6614*
Base Gasket (.012/0.3mm)	290-931-720	6035.3
Base Gasket (.017/0.4mm)	290-931-721	6035.4
Base Gasket (.020/0.5mm)	270-931-722	6035.5*
Base Gasket (.024/0.6mm)	290-931-723	6035.6
Base Gasket (.030/0.8mm)	290-931-724	6035.8
Carb Gasket 41mm (2 required)	293-250-042	6107*
Power Valve Gasket (2 required)	290-931-540	6618
Power Valve O-Ring (2 required)	290-430-110	6622
Exhaust Gasket	290-931-480	6082*
Head Pipe Gasket	290-931-500	6155*
Balance Shaft O-Ring	290-230-300	6624
Manifold O-Ring	290-831-765	6628
Rotary Valve Shaft O-Ring	293-300-024	6260
Starter O-Ring	278-000-694	6152
Flywheel Housing Gasket	290-931-470	6045
Flywheel Cover O-ring	290-950-360	6632
Oil Pump O-Ring	293-300-018	6255
PTO O-Ring	290430-782	6220

	OEM No.	Part No.
Top Kit 951 '97	White Engine	6825
Complete Kit 951 '97	White Engine	6830
Top Kit 951 '98	Silver Engine	6840
Complete Kit 951 '98	Silver Engine	6842
Head Gasket	290-931-700	6700*
Head Gasket (91.25)		6700BB
Base Gasket '97	290-931-680	6730.3*
Base Gasket '97	290-931-681	6730.4*
Base Gasket '97	290-931-682	6730.6*
Base Gasket '98	290-931-685.5	6732.5*
Base Gasket '98	290-931-686.6	6732.6*
Base Gasket '98	290-931-687.8	6732.8*
Carb Gasket 48mm (2 required)	270-500-384	6740*
Power Valve O-Ring (2 required)	290-430-110	6622*
Power Valve Housing O-Ring	290-931-670	6750*
Exhaust Gasket (2 required)	293-250-081	6760*
Headpipe Gasket 97	290-931-487	6770*
Headpipe Gasket 98	429-931-488	6775*
Stud O-Ring	290-850-460	6780
Balance Shaft O-Ring	290-230-300	6624
Starter O-Ring	278-001-159	6790
Flywheel Housing	290-931-690	6795
Oil Pump O-Ring	293-300-018	6255

SEA-DOO 800 DI

	OEM No.	Part No.
800 DI Top Kit		6855
800 DI Complete Kit	ALL	6860
Head Cover O-Ring	420-831-550	6612*
Spark Plug O-Ring (2 Req'd)	420-430-782	6220*
Cylinder O-Ring (2 Req'd)	420-931-410	6185*
Water Jacket O-Ring (2 Req'd)	420-931-420	6614*
Base (3 Hole 0.12)	420-931-728	6035.3
Base (4 Hole 0.16)	420-931-728	6035.4*
Base (6 Hole 0.24)	420-931-728	6035.6
Power Valve O-Ring (2 Req'd)	290-931-765	6622
Power Valve Housing O-Ring	290-931-670	6750
Exhaust	290-931-481	6082*
Headpipe	420-931-503	6155*
Balance Shaft O-Ring	290-230-300	6624
Manifold O-Ring	290-831-767	6628
Rotary Valve Shaft O-Ring	293-300-024	6260
Starter O-Ring	278-000-694	6152
Flywheel Housing Gasket	290-931-470	6045
Flywheel Cover O-Ring	290-950-360	6632
Oil Pump O-Ring	293-300-018	6255
Case Plug O-Ring	290-250-890	6650
Intake Manifold O-Ring	420-850-520	6655
Rectifier Cover O-Ring	420-850-390	6784
Bearing Cover O-Ring	420-230-300	6624
Sump Cover O-Ring	420-950-360	6205

SEA-DOO 951 DI

	OEM No.	Part No.
950 DI Top Kit	2000+	6875
950 DI Complete Kit	2000+	6880
Head	420-931-706	6705*
Base (3 Hole 0.12)	420-931-905.3	6734.3*
Base (4 Hole 0.16)	420-931-905.4	6734.4*
Base (6 Hole 0.24)	420-931-9053.6	6734.6*
Reed (Not Req'd w/Stock Reeds)		6745
Power Valve O-Ring (2 Req'd)	290-850-460	6622*
Power Valve Housing O-Ring	290-931-670	6750*
Exhaust (2 Req'd)	293-250-081	6760*
Headpipe	420-931-990	6870*
Balance Shaft O-Ring	290-230-300	6624
Starter O-Ring	278-001-159	6790
Flywheel Cover	290-931-690	6795
Oil Pump O-Ring	293-300-018	6255
Engine Bottom Cover O-Ring	420-931-880	6782
Rectifier Cover O-Ring	420-850-390	6784
Compressor	420-230-300	6624
Compressor Gasket	420-931-870	6850
O-Ring	293-300-054	6862
O-Ring	293-300-076	6865
O-Ring	293-300-070	6868





INDIVIDUAL GASKETS FOR YAMAHA

WAVE JAMMER, WAVE RUNNER 500

	OEM No.	Part No.
Complete Kit		51-4803
Head	6K8-1181	2000
Carb	6K8-13556	2010
Thermostat Cover	655-12414	2020
Reed	6K8-13621	2030
Oil Seal Housing	6K8-15369	2040
Flywheel Cover	6K8-81365	2050
Flame Arrestor	6K8-13674	2060
Exhaust Cover #1	6K8-41124	2070
Exhaust Cover #2	6K8-41122	2080
Exhaust Cover Inner	6K8-41112	2090
Exhaust Cover Outer	6K8-41114	2100
Muffler Damper #1	6K8-14739	2110
Muffler Damper #2	6K8-14749	2120
Silencer	6K8-14755	2130
Upper Case	6K8-45113	2140

650 SUPERJET 90-93, WR111 90-93

	OEM No.	Part No.
Top Kit		2600
Complete Kit		2650
Head 77mm .050	6R7-11181	2205*
Base	6M6-11351	2220*
Carb (2 required)	6M6-13556	2230*
Top Manifold	6M6-13563	2240*
Lower Manifold	6M6-13566	2260*
Reed (2 required)	6M6-13621	2280*
Exhaust	6M6-14613	2310*
Oil Pump	6R8-13116	2340
Air Cleaner (2 required)	6M6-13674	2350
Flywheel Cover	6M6-81365	2360
Head Pipe	6R7-14755	2370
Outer Cover	6R7-41114	2380
Damper	6R7-14749	2390
Exhaust Pipe (2 required)	6M6-14739	2400
Head Cover	6M6-11193	2410

701 SUPERJET 94-95, BLASTER 93-95 WAVE RAIDER 96, WR111 94-95

	OEM No.	Part No.
Top Kit		2700
Complete Kit		2750
Head 82mm .050	61X-11181A	2215*
Base	6M6-11351	2220*
Carb (2 required)	6M6-13556	2230*
Top Manifold	61X-13563	2250*
Lower Manifold	61X-13566	2270*
Reed (2 required)	61X-13621	2290*
Exhaust Green	61X-14613	2330*
Oil Pump	6R8-13116	2340
Flame Arrestor (2 required)	6M6-13674	2350
Flywheel Cover	6M6-81365	2360
Silencer (aka Head Pipe)	6R7-14755	2370
Outer Cover	6R7-41114	2380
Damper	6R7-14749	2390
Exhaust Pipe	6M6-14739	2400
Head Cover	6M6-11193	2410

* Denotes when the gasket is included in the Top End Gasket Set.

701 SUPERJET 96-15 WAVE BLASTER 96

	OEM No.	Part No.
Top Kit		2550
Complete Kit		2555
Head 82mm	62T-11181	2215*
Base	6M611351	2220*
Reed (2 required)	62T-13566	2830*
Carb Manifold	62T13556	2820*
Carb Base (2 required)	-	5460
Exhaust Green	61X-14613	2330*
Oil Pump	6R8-13116	2340
Arrestor (2 required)	62T-13674	2825
Flywheel Cover	6M6-81365	2360
Head Pipe	6R7-17455	2370
Outer Cover	6R741114	2380
Damper	6R7-14749	2390
Exhaust Pipe	6M6-14739	2400

701 WAVE RAIDER 94-95, WAVE VENTURE 95+

	OEM No.	Part No.
Top Kit		2950
Complete Kit		2980
Head Green	62T-11181	2810*
Base	6M6-11351	2220*
Carb Base	62T-14398	5030*
Carb Manifold	62T-13556	2820*
Air Cover	62T-13674	2825
Flywheel Cover	6M6-81365	2360
Reed (2 required)	62T-13566	2830*
Exhaust Green	62T-14613	2850*
Muffler Damper 1	62T-14739	2860
Head Pipe	62T-14749	2870
Exhaust Outer Cover #1	62T-41114	2880
Exhaust Inner Cover	62T-41122	2890
Exhaust Outer Cover #2	62T-41124	2900
Oil Pump	6R8-13116	2340
Ignition Box Cover	6M6-81921	2116A

760 WAVE RAIDER 96+, BLASTER II 96+, XL760W

	OEM No.	Part No.
Top Kit		2990
Complete Kit		2992
Head .025 Stainless	64X-11181	3200*
Head .050 86mm	Ultimate	3210
Base	6M6-11351-A2	3205*
Carb Base (2 required)	62T-14398	5460*
Carb Manifold	64X-13556	3220*
Arrestor (2 required)	64X-13674	3230*
Reed (2 required)	62T-13566	2830*
Exhaust Green	62T-14613	2850*
Flywheel Cover	6M6-81365	2360
Head Pipe	64X-14749	2870
Exhaust Outer Cover #1	62T-41114	2880
Exhaust Inner Cover	62T-41122	3240
Outer Cover Exhaust	62T-41124	3250
Oil Pump	6R8-13116	2340

GP800 98+

	OEM No.	Part No.
Top Kit		3520
Complete Kit		3530
Head .025 Stainless		3400*
Head .050 82mm	Ultimate	3410
Base (2 required)		3420*
Carb Base		5460
Carb Manifold		3430*
Exhaust Green		3450*
Head Pipe		3460
Power Valve (2 required)		3470
Exhaust Section		3480
Oil Pump		2340



FOUR STROKE
INTAKE SYSTEMS
ENGINE/GASKETS
EXHAUST
DRIVE LINE HANDLING
ELECTRICAL
WATERLINE /BILGE
STEERING & CONTROLS
BODY
ACCESSORIES
SERVICE TOOLS
HARDWARE
CHEMICAL

INDIVIDUAL GASKETS FOR YAMAHA

1100 WAVE VENTURE / WAVE RAIDER

	OEM No.	Part No.
Top Kit		4520
Complete Kit		4530
Head .050 82mm	63M-11181	4400*
Base	63M-11351	4415*
Carb Base	63M-14398	5030
Carb Manifold	63M-13556	4420*
Reed (2 required)	63M-13566	4430*
Exhaust	63M-14613	4450*
Muffler Damper 1	63M-14739	4455
Muffler Damper 2	63M-14749	4460
Exhaust Outer Cover (2 required)	63M-41114	4470
Exhaust Inner Cover	63M-41122	4480
Head Cover	63M-11193	4500
Flywheel Cover	63M-81365	4505
Oil Pump	63M-13116	4510

YAMAHA GP 1200, XL 1200 98+

	OEM No.	Part No.
Top Kit		4680
Complete Kit		4685
Head .025 86mm	65U-11181	4600*
Head .050 86mm Green	Ultimate	4610
Base	65U-11351	4615*
Carb Base XL 1200 W	65U-13556	5460
Carb Manifold	64X-14162	4620*
Spark Arrester	-	4630
Reed (2 required)	65U-13566	4430*
Exhaust	65U-14613	4650*
Muffler Damper 1	63M-14739	4455
Head Pipe	63M-14749	4460
Exhaust Outer Cover (2 required)	63M-41114	4470
Exhaust Inner Cover	63M-41122	4480
Head Cover	63M-11193	4500
Flywheel Cover	63M-81365	4505
Oil Pump	63M-13116	4510

YAMAHA GP 1200R, XL 1200LTD

	OEM No.	Part No.
Top Kit		3730
Complete Kit		3740
Head .025 Stainless Steel	66V-11181	3600*
Base (3 Required)	66E-11351	3420*
Carb Base (3 Required)	66E-14398	3425*
Carb Manifold	66V-13556	3620*
Reed	-	3435
Reed Center	-	3440
Power Valve (3 Required)	66E-1131B-0	3470
Exhaust Green	66V-14613	3650
Head Pipe	66V-14739	3660
Chamber	66V-14749	3670
Outer Cover #1	66V-41114	3680
Outer Cover #2	66V-41124	3690
Tail Cone	66V-14623	3700
Starter O-Ring	1FK-81847	3490
Oil Pump	63M-13116	2340
Head Cover	66V-11193	3610

* Denotes when the gasket is included in the Top End Gasket Set.

YAMAHA 1300 GPR

	OEM No.	Part No.
1300 Top Kit		3800
1300 Complete Kit		3810
Head .025 Stainless Steel	66V-11181	3605*
Base (3 Req'd)	66E-11351	3420*
Carb Manifold	66V-13556	3620
Manifold Gasket (2 Req'd)	60T-13556-00	3622*
Reed	NOE	3435
Reed Center	NOE	3440
Power Valve (3 Req'd)	66E-1131B-01	3470
Exhaust	66V-14613	3650
Head Pipe	66V-14739	3660
Chamber	66V-14749	3670
Outer Cover #1	66V-41114	3680
Outer Cover #2	66V-41124	3690
Tail Cone	66V-14623	3700
Starter O-Ring	1FK-81847	3490
Oil Pump	63M-13116	2340



INDIVIDUAL GASKETS FOR KAWASAKI

440 ALL

	OEM No.	Part No.
Complete Kit 81-92		51-1503
Head	11004-3707	5200
Base	11009-505	5240
Intake	11009-3785	5250
Carb Base 38mm	11009-3786	5030
Housing Pre 82	92065-515	5270
Exhaust	11009-3779	5280
Headpipe Green	11060-3710	5290
Arrester 38mm	11060-3702	5080

550 1982-85, 1986-90

	OEM No.	Part No.
Top Kit 1982-85		5550
Complete Kit 1982-85		5560
Top Kit 1986-90		5570
Complete Kit 1986-90		5580
Head All	11004-3709	5400*
Base	11009-3782	5430*
Intake (2 required)	11009-3785	5250*
Carb Base 38mm Pre 86	11009-3786	5030*
Carb Base 44mm 86-90	11060-3743	5460*
Exhaust	11009-3779	5280*
Headpipe 82-85	11009-3051	5480
Conn Pipe Lower 82-85	11060-3730	5490
Headpipe	11060-3726	5500
Conn Pipe 86-90	11060-3727	5510
Chamber 86-90	11060-3278	5520
Arrester 38mm Pre 86	11060-3702	5080
Arrester 44mm 86-90	11060-3744	5540

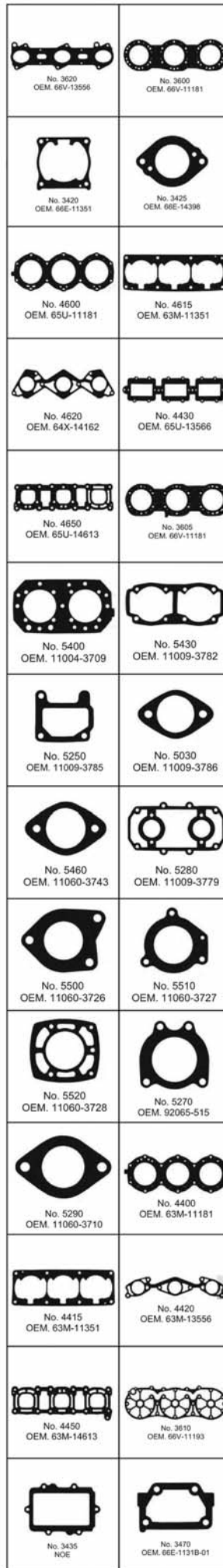

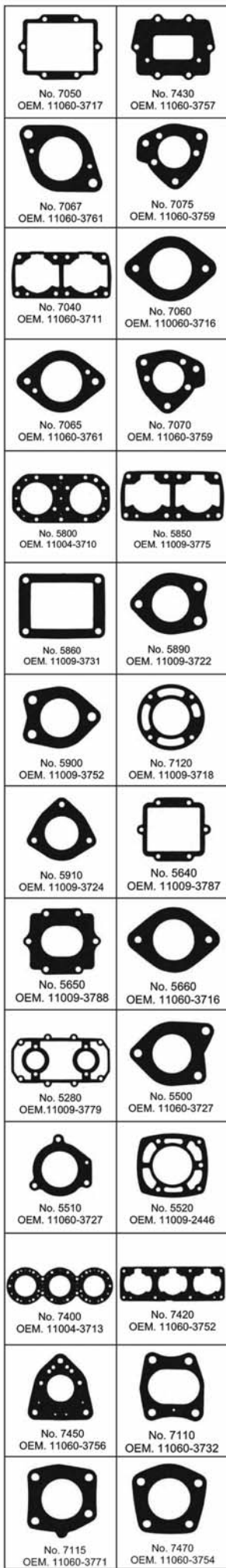

INDIVIDUAL GASKETS FOR KAWASAKI

550SX 1991-95

	OEM No.	Part No.
Complete Kit		51-2403
Head .010 Stainless	11004-3706	51-2409
Head .047 Green		5610
Base .010 Stainless	11009-3780	5630
Base .020 Fiber		5635
Reed	11009-3787	5640
Intake	11009-3788	5650
Keihin 38mm	11060-3716	5660
Exhaust	11009-3779	5280
Headpipe	11060-3726	5500
Conn Pipe	11060-3727	5510
Chamber	11009-2446	5520

KAWASAKI 650, X2/TS/SC

	OEM No.	Part No.
650 Complete		5940
650 X2, TS Complete		5960
Head .010 Stainless	11004-3710	5800
Head .040 Green	Ultimate	5830
Base	11009-3775	5850
Reed	11009-3731	5860
Keihin 28mm Carb Base	11009-3747	5870
Keihin 38mm Carb Base	11060-3716	5660
Exhaust	11009-3722	5880
Head Pipe	11009-3752	5890
(OEM Exhaust Manifold)		
Head Pipe (Factory Pipe)	11009-3752	5900
46mm ID Green		
Muffler TS	11060-3718	7120
X-2 Conn Pipe	11009-3724	5910
Control Valve All	11060-3723	7150

750SX, SXI, SXI PRO

	OEM No.	Part No.
Top Kit	All 750	7200
Complete Kit	SX/SXI	7210
Head .010 Stainless - 81.36mm	11004-3714	7000*
Base	11060-3711	7040*
Reed A SX(4pcs) SXI(2pcs)	11060-3717	7050*
Reed B SXI(2pcs)	11060-3757	7430*
40mm Carb	11060-3716	7060*
40mm Carb SXI 96+	11060-3761	7065*
Exhaust (2 required)	11060-3759	7070*
Head Pipe SX, SXI	11060-3712	7080
Upper Muffler SX, SXI	11060-3713	7090
Muffler SX, SXI	11060-3714	7140
Control Valve All	11060-3723	7150

* Denotes when the gasket is included in the Top End Gasket Set.

750 SS, XI, XIR

	OEM No.	Part No.
Top Kit	All 750	7200
Complete Kit	SS/XI	7220
Complete Kit	SS 92-93	7240
Complete Kit	XIR	7230
Head .010 Stainless - 81.36mm	11004-3714	7000*
Base All	11060-2711	7040*
Reed (4pcs) SS92+, XI93-95, XI	11060-3717	7050*
Reed A XI 96 (2 pcs)	11060-3717	7050*
Reed B XI 96 (2 pcs)	11060-3757	7430*
40mm Carb SS, XI, XIR	11060-3716	7060*
40mm Carb XI 96	11060-3758	7060*
Exhaust All	11060-3721	7070
Head Pipe SS 92-93	11060-3720	7100
Head Pipe SS 94+, ST, XI 93+	11060-3732	7110
Head Pipe (XIR)	11009-3752	5900
Muffler XI, SS	11060-3718	7120
Control Valve All	11060-3723	7150

750 STS, ZXI

	OEM No.	Part No.
Top Kit	ALL 750	7200
750 Complete	95 STS	7225
750 Complete	ZXI 95+	7245
Head .010 Stainless - 81.36mm	11004-3714	7000*
Base All	11060-3711	7040*
Reed A ZXI, STS (2), ST (4)	11060-3717	7050*
Reed B ZXI, STS (2)	11060-3757	7430*
40mm Carb ZXI, STS (2)	11060-3758	7060*
Exhaust STS 95-96, ZXI (2)	11060-3721	7070*
Headpipe 95 STS	11060-3732	7110
Headpipe 96 STS	11060-3771	7115
Headpipe ZXI 95-96	11060-3754	7470
Muffler 1 95 STS	11060-3718	7120
Exhaust Joint STS 96	11060-3763	7125
Muffler 1 96 STS	11060-3766	7135
Muffler 2 96 STS	11060-3770	7145
Muffler ZXI 95-96	11060-3755	7480
Control Valve All	11060-3723	7150

KAWASAKI 800 SXR

	OEM No.	Part No.
800 Top Kit		7300
800 Complete Kit		7310
Head .010 Stainless 82.33mm	11004-3720	7005*
Base SXR	11060-3711	7040*
Reed SXR (4 required)	11060-3717	7050*
Reed SXR (2 required)	11060-3757	7430*
40mm Carb SXR (2 required)	11060-3761	7067*
Exhaust SXR (2 required)	11060-3759	7075*
Headpipe SXR	11060-3712	7080
Upper Muffler SXR	11060-3713	7090
Muffler SXR	11060-3714	7140

KAWASAKI 900 ZXI 95+

	OEM No.	Part No.
Top Kit		7500
Complete Kit		7520
Head .010 Stainless	11004-3713	7400*
Head .040 Fiber		7410
Base	11060-3752	7420*
Reed Engine (3 required)	11060-3717	7050*
Reed Carb (3 required)	11060-3757	7430*
Exhaust (3 required)	11060-3756	7450*
Carb Base	11060-3753	7460
Headpipe	11060-3754	7470
Muffler	11060-3755	7480

FOUR STROKE
INTAKE SYSTEMS
ENGINE/GASKETS
EXHAUST
DRIVE LINE HANDLING
ELECTRICAL
WATERLINE /BILGE
STEERING & CONTROLS
BODY
ACCESSORIES
SERVICE TOOLS
HARDWARE
CHEMICAL

KAWASAKI 1100ZXI 96-98

	OEM No.	Part No.
Top Kit		7670
Complete Kit		7680
Head .010 Stainless	11004-3715	7600
Head .040 Fiber		7605
Base	11060-3760	7615
Reed Engine (3 required)	11060-3717	7050
Reed Carb (3 required)	11060-3757	7630
Exhaust Manifold (3 required)	11060-3767	7650
Carb Base Gasket (3 required)	11060-3775	7652
Carb Base Gasket (1 required)	11060-3776	7655
Exhaust Head Pipe	11060-3768	7660
Headpipe to Muffler	11060-3769	7665

KAWASAKI ULTRA 150 99+

	OEM No.	Part No.
Top Kit		7830
Complete Kit		7835
Head Stainless Steel .010*	11004-3717	7700*
Base	11060-3783	7715*
Water Pipe	11060-3785	7720
Reed (3 Req'd)	11060-3717	7050*
Reed Carb (3 Req'd)	11060-3757	7630*
Exhaust (3 Req'd)	11060-3785	7750*
Carb (3 Req'd)	11060-3788	7760
Head Pipe	11060-3786	7770
Exhaust Body	11060-3787	7780
Flywheel Cover	11060-3803	7790

INDIVIDUAL GASKETS FOR POLARIS

700 HURRICANE, VIRAGE, FREEDOM

	OEM No.	Part No.
Top Kit		4375
Complete Kit		4378
Head O-Ring (2 required)	5410931	4300*
Cylinder O-Ring (2 required)	5410932	4305*
Spark Plug O-Ring (2 required)	5410917	4310*
Base (2 required)	5811057	4315*
Base Virage-Freedom (2 required)	5811784	4805*
Reed Engine Side	N.O.E	4317
Reed Carb Side	N.O.E	4319
Carb (2 required)	5830043	4320*
Arrestor	5830062	4325
Exhaust (2 required)	5811045	4330*
Headpipe (2 required)	5830051	4335*
Flywheel Cover	5811145	4337
Water Manifold (2 required)	5830061	4339
Oil Pump O-Ring	5411056	4340
Thermostat Housing	5410860	4353
Crank O-Ring	5410613	4356
Starter O-Ring (2 required)	3240114	4359

POLARIS 650/750

	OEM No.	Part No.
650 Top Kit		4200
650 Complete Kit		4210
750 Top Kit		4220
750 Complete Kit		4230
Head 650 .010 Stainless (3 req'd)	3240057	4000*
Head 750 .040 Stainless (3 req'd)	3240213	4010*
Head 650 .040 Fiber	Ultimate	4020
Base .020 (3 required)	3240055	4040*
Reed(6 required)	3084148	4050*
Carb (6 required)	3240128	5030*
Arrestor	5830013	4065
Exhaust (3 required)	5211489	4070*
Headpipe	5830038	4080*
Water Manifold (3 required)	3082937	4100
Thermostat Housing	5410781	4110
Oil Pump O-Ring	3083127	4112
Starter O-Ring (2 required)	3240114	4359

POLARIS 780, 785 PRO

	OEM No.	Part No.
Head 780 Stainless (3 required)	3240251	Discontinued
Head 785 Stainless (3 required)	3240305	Discontinued
Base (3 required)	3240249	4040*
Reed (3 required)	3084148	4050*
Carb (3 required)	3240128	5030*
Carb 785 (3 required)	3240358	9240*
Arrestor (3 required)	5830013	4065*
Arrestor 785 (3 required)	5830115	5540*
Exhaust	5211623	4077*
Exhaust 785	5211725	4078
Exhaust 785 O-Ring (6 required)	5411311	4079
Head Pipe	5830038	4080*
Power Valve 785 (3 required)	3240313	4085
Water Manifold	3082937	4100
Oil Pump O-Ring	3083127	4112
Thermostat Housing	5410781	4110
Starter O-Ring	3240114	4359

POLARIS 900/1050

	OEM No.	Part No.
Top Kit 900		4380
Complete Kit 900		4383
Top Kit 1050		4385
Complete Kit 1050		4390
Head O-Ring (3 required)	5410931	4300*
900 Cylinder O-Ring (3 required)	5411044	4303*
1050 Cylinder O-Ring (3 required)	5410932	4305*
Spark Plug O-Ring (3 required)	5410917	4310*
Base 900 (3 required)	5811057	4315*
Base 1050 (3 required)	5830123	4316
Reed		4318
Carb (3 required)	5830043	4320
Arrestor	5830062	4325
Exhaust (3 required)	5811045	4330*
Headpipe	5830051	4335
Flywheel Cover	5811145	4337
Water Manifold	5830061	4339
Oil Pump O-Ring	5411056	4340
Thermostat Housing	5410860	4353
Crank O-Ring	5410613	4356
Starter O-Ring	3240114	4359

INDIVIDUAL GASKETS FOR TIGER SHARK

TIGER SHARK 639, 644

	OEM No.	Part No.
Top Kit 639/644		3100
639 Complete Kit		3110
644 Complete Kit		3120
Head	3008-174	3000*
Head 639,644 77MM .040	Ultimate	3010
Base	3008-050	3030*
Reed (4 required)	3008-076	3040*
Carb Base 44mm	3008-057	5460*
Exhaust (2 required)	3008-080	3060*
Head Pipe	3008-081	3070
Connector Pipe 644 only	3008-082	3080
Air Cleaner	3008-058	3090

* Denotes when the gasket is included in the Top End Gasket Set.

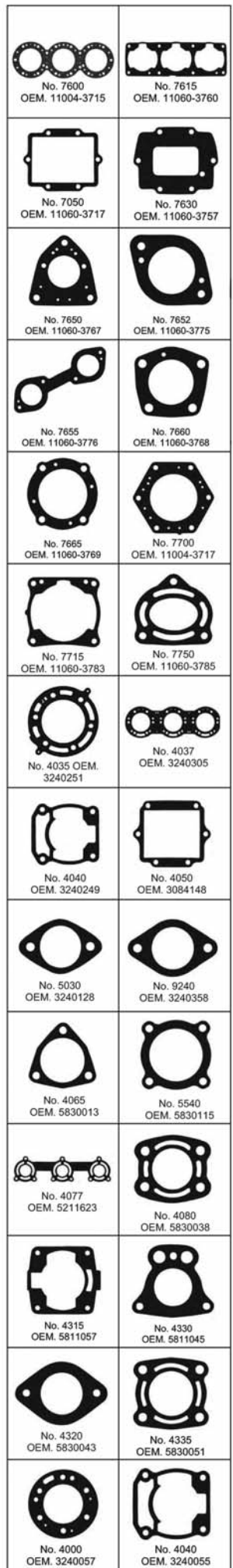

INDIVIDUAL GASKETS BY SECTION



HEAD GASKETS

Head gaskets for all applications including high performance racing applications. All gaskets meet or exceed the OEM manufacturers specifications.

Head gaskets are available in: Metal, Copper, and "Ultimate" Green fiber.

Sea-Doo Cylinder	Type	Part No.
O ring set 580 92+	O-Ring	6170
O ring set 650	O-Ring	6180
O ring set 720/785	O-Ring	6185
951 (carb) 97+	Metal 89mm Bore	6700
951 (carb) 97+	Metal 91.25mm Bore	6700BB
951 DI	Metal 88-90mm	6705
4-Tec	Metal	6900
4-Tec	Metal	007-399-05*

Sea-Doo Head Cover	Type	Part No.
O ring 580 Yellow Engine	O-Ring	6200
O-Ring 580 White Engine/720	O-Ring	6205
O ring 650	O-Ring	6210
O ring 785	O-Ring	6612

Polaris	Thickness	Type	Part No.
650	0.040	Green (3 Required)	4020
750	0.040	Green (3 Required)	4030
650	0.010	Metal (3 Required)	4000
750	0.010	Metal (3 Required)	4010
780	0.010	Metal (3 Required)	4035
785	0.010	Metal (3 Required)	Discontinued

Polaris Head O-Ring	Part No.
700 Hurricane/900/1050	4300

Polaris Cylinder O-Ring	Part No.
700 Hurricane/1050	4305
900	4303



2015 NORTHWEST JET SPORTS ASSOCIATION TOUR, AT DEVIL'S LAKE, LINCOLN CITY, OREGON, ON APRIL 25-26.

Yamaha	Thickness	Type	Part No.
500 All	0.040	Fiber	2000
500 All	0.047	Green	2005
650 All 77mm	0.047	Green	2205
701 All 82mm	0.047	Green	2215
701 W/Raider	0.047	Green	2810
760 86mm	0.047	Green	3210
GP800	0.047	Green	3410
1100 82mm	0.047	Green	4400
1200 86mm	0.047	Green	4610
760 86mm	0.025	Metal	3200
GP800	0.025	Metal	3400
1200 86mm	0.025	Metal	4600
GP1200R,XL1200LTD	0.025	Metal	3600
FX140, Cruiser, FX	—	Metal	007-593-05*
FX140 HO (04-08)	—	Metal	007-593-06*
VX110, Cruiser, DLX	—	Metal	007-593-03*
FX SHO (08-10)			007-593-07*
FX Cruiser SHO (08-10)			
FZR (09-10)			
FZS (09-10)			
FX Cruiser HO (09-13)			007-593-11*
FX Cruiser SHO (11-13)			
FX HO (09-13)			
FZR (11-12)			
FZS (11-13)			
VXR (11-12)			
VXS (11-12)			

Kawasaki	Thickness	Type	Part No.
440 77-80	0.040	Fiber	51-1206
440 81-92	0.040	Fiber	5200
550 JS 82-90	0.040	Fiber	5400
550 JS 82-90	0.047	Green	5420
550 SX 91-95	0.047	Green	5610
550 SX 91-95	0.010	Metal	51-2409
650 All	0.040	Green	5830
750 All	0.040	Green	7020
900 ZXI	0.040	Green	7410
1100 ZXI	0.040	Green	7605
550 91-	0.010	Metal	51-2409
650 All	0.010	Metal	5800
750 All (81.36mm)	0.010	Metal	7000
900 ZXI	0.010	Metal	7400
1100 ZXI	0.010	Metal	7600
550 91-	0.020	Copper	51-2410
800 SX-R (82.33mm)	0.010	Metal	7005
800 SX-R	0.005	Copper	H1896005C
800 SX-R	0.010	Metal	7000BB
Big Bore 83.25mm			
800 SX-R			7000BB-8470
Big Bore 84.7mm			
STX 12F/15F, Ultra LX			007-315*
Ultra 250/260			007-315-06*
Ultra 300			007-315-07*

*Indicates specific head gasket manufactured by WSM

FOUR STROKE
INTAKE SYSTEMS
ENGINE/ GASKETS
EXHAUST
DRIVE LINE HANDLING
ELECTRICAL
WATERLINE /BILGE
STEERING & CONTROLS
BODY
ACCESSORIES SERVICE TOOLS
/HARDWARE
CHEMICAL

INDIVIDUAL GASKETS BY SECTION

INTAKE & REED GASKETS (Intake Manifold to Cylinder or Cases)

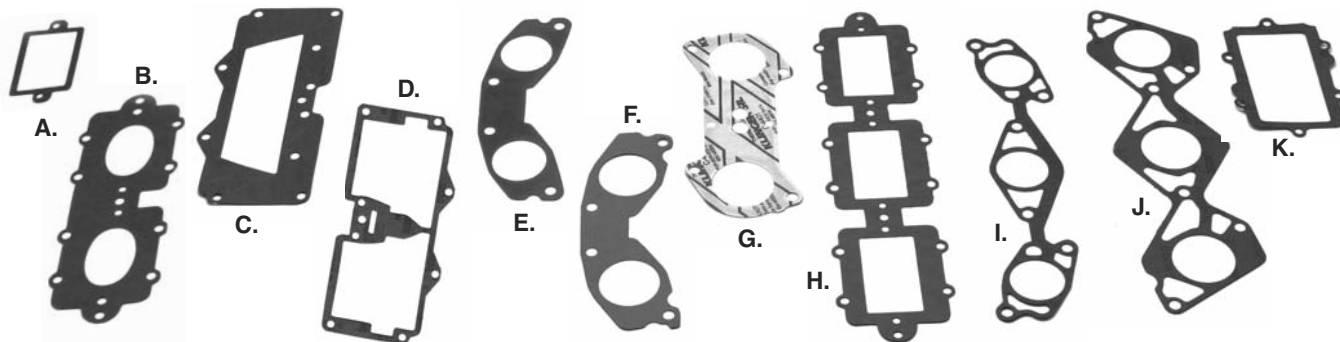

	Yamaha	OEM#	Part No.
A.	701 Reed	61X-13621	2290
B.	760 W/Rdr Reed/701 96+	62T-13566	2830
C.	701 Top Manifold	61X-13563	2250
D.	701 Lower Manifold	61X-13566	2270
E.	SJ,W/Blster 701 96+/WRdr 701	62T-13556	2820
F.	760 Carb Manifold	64X-13556	3220
G.	800 Carb Manifold	64E-13556	3430
H.	1100/1200 Reed	63M-13566	4430
I.	1100 Carb Manifold	64M-13556	4420
J.	1200 Carb Manifold	64X-14162	4620
K.	GP1200R/XLL1200 Reed		3435

	Yamaha	OEM#	Part No.
	500 Reed	6K8-13261	2030
	650 All Reed	6M6-13621	2280
	650 Top Intake	6M6-13563	2240
	650 Bottom Intake	6M6-13566	2260

	Kawasaki	OEM#	Part No.
	440/550 Intake	11009-3785	5250
	550SX Intake	11009-3788	5650
	550SX Reed	11009-3787	5640
	650 All Reed	11060-3703	5860
	750/900/1100 Engine	11060-3717	7050
	750/900/1100 Reed Carb	11060-3757	7430

	Polaris	OEM#	Part No.
	650/750/780/785 Reed	308448	4050
	900/1050/Reed		4318
	700/Hurricane Reed Engine Side		4317
	700/Hurricane Reed Carb Side		4319



EXHAUST HEADPIPE GASKETS

See Page 164 for Factory Pipe Exhaust Gaskets

	Sea-Do	OEM#	Part No.
L.	580 -92	290-950-250	6140
M.	580 92+/650/720	290-950-251	6150
N.	785	290-931-500	6155
O.	951 97	290-931-487	6770
P.	951 98+	290-250-080	6775

	Polaris	OEM#	Part No.
Q.	650/750/780/785	5830038	4080
R.	700/Hurricane/900/1050	5830051	4335

	Yamaha	OEM#	Part No.
S.	650/701	6R7-14755	2370
T.	701 WRD 94-95	62T-14749	2870
T.	760	64X-14749	2870
U.	1100/1200	63M-14749	4460
V.	800	66E-14749	3460

	Kawasaki	OEM#	Part No.
1X.	440/550	11009-3051	5290
2X.	650 All (46mm ID)	11009-3752	5890
3X.	750 SX/SXi/800 SXR	11060-3712	7080
4X.	750 SS 92-95	11060-3720	7100
5X.	750 Xi 93-96	11060-3732	7110
6X.	900 (Headpipe)	11060-3754	7470
7X.	1100 (Headpipe)	11060-3768	7660
8X.	900 (Muffler)	11060-3755	7480
9X.	1100 (Muffler)	11060-3769	7665

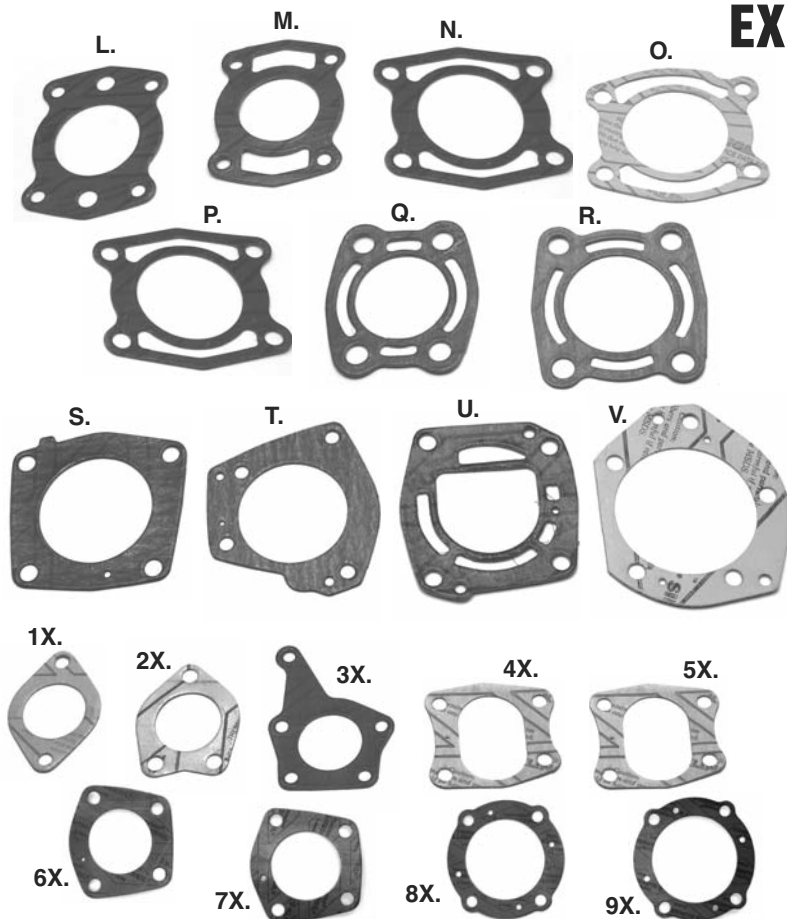

INDIVIDUAL GASKETS BY SECTION (Cylinder to Manifold)

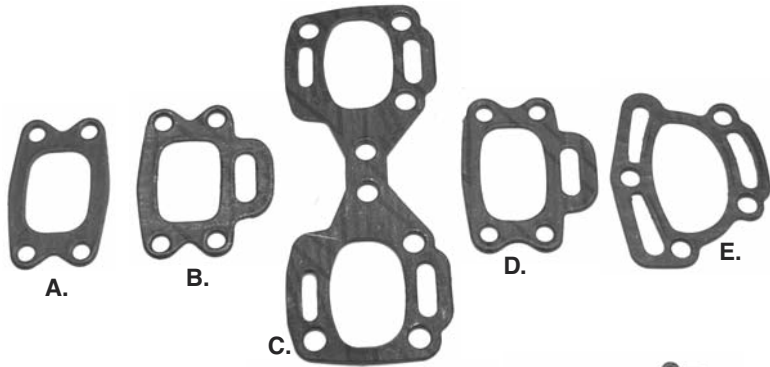

A.

B.

C.

D.

E.

F.

G.

H.

I.

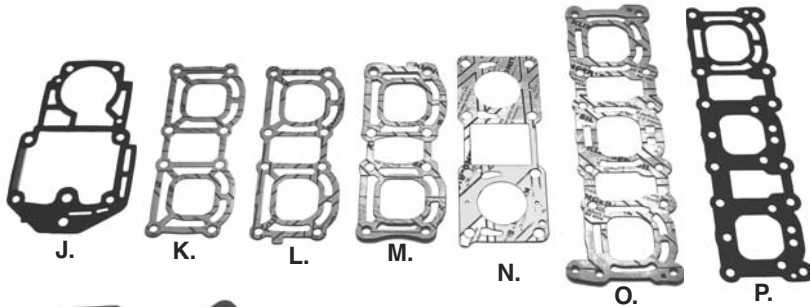

J.

K.

L.

M.

N.

O.

P.

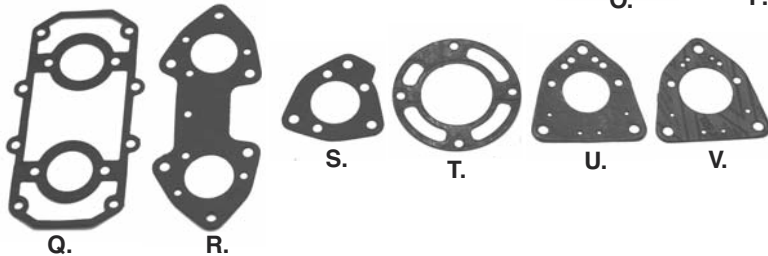

Q.

R.

S.

T.

U.

V.



W.

EXHAUST MANIFOLD GASKETS

(cylinder to manifold)

Sea-Doo	OEM#	Part No.
A. 580 All -91	420-850-632	6050
B. 580 All 92+	290-850-635	6060
C. 785	290-931-480	6082
D. 650/720	290-850-637	6080
E. 951	290-250-081	6760

EXHAUST MANIFOLD GASKETS

(cylinder to manifold)

Polaris	OEM#	Part No.
F. 650/750	5211489	4070
G. 700/Hurricane/900/1050	5811045	4330
H. 780	5211623	4077
I. 785	5211725	4078

EXHAUST MANIFOLD GASKETS

(cylinder to manifold)

Yamaha	OEM#	Part No.
J. 500	6K8-45113	2140
K. 650 All	6M6-14613	2310
L. 701	61X-14613	2330
M. 701/760 W/Rdr	62T-14613	2850
N. 800	66E-14613	3450
O. 1100	63M-14613	4450
P. 1200	65W-14613	4650

EXHAUST MANIFOLD GASKETS

(cylinder to manifold)

Kawasaki	OEM#	Part No.
Q. 440/550	11009-3779	5280
R. 650 (86-90)	11060-3739	5880
S. 650/750/800 SXR	11060-3759	7075
T. 750 SS-X1	11060-3718	7120
U. 900	11060-3756	7450
V. 1100	11060-3767	7650

Kawasaki

Part No.
W. Kommander Kaw 1100/1200 Triple High Flow Exhaust Gasket (Sold Individually)
KOM-13-ZXI
Kommander Kaw 800SXR Performance (OPEN) Exhaust Gasket (Sold in Pairs)
KOM-036-OPEN

ThreeBond



1211 (White)



1207 B (Black)

THREE BOND SILICON GASKET

#1211 (White) Silicon Liquid Gasket

High grade silicon liquid gasket used by many OEMs in aluminum case assembly. 1211 is tack free in 90 minutes and fully cured in 24 hours.

#1207B (Black) Quick Dry Silicon Gasket

Crankcase sealer for large gaps, sheet metal, tough to seal areas, and vertical applications. 1207B is tack free in 5 minutes and fully cured in 24 hours.

Descriptions

Part No.
Silicon Liquid Gasket (White)
1211AT100
Quick Dry Silicon Liquid Gasket (Black)
1207B100G

INDIVIDUAL GASKETS BY SECTION



BASE GASKETS

Sea-Doo	OEM#	Part No.
580 -91	290-850-775	6000
580 92+/650	290-931-161	6020.3
580 92+/650	290-931-162	6020.4
580 92+/650	290-931-163	6020.5
580 92+/650	290-931-164	6020.6
580 92+/650	290-931-165	6020.8
720 0.3mm	290-931-400	6025.3
720 0.4mm	290-931-401	6025.4
720 0.5mm	290-931-402	6025.5
720 0.6mm	290-931-403	6025.6
720 0.8mm	290-931-404	6025.8
785 0.3mm	290-931-720	6035.3
785 0.4mm	290-931-721	6035.4
785 0.5mm	290-931-722	6035.5
785 0.6mm	290-931-723	6035.6
785 0.8mm	290-931-724	6035.8
951 97	290-931-680	6730.3
951 97	290-931-681	6730.4
951 97	290-931-682	6730.6
951 98+	290-931-685.5	6732.5
951 98+	290-931-686.6	6732.6
951 98+	290-931-687.8	6732.8

Polaris	Part No.
650/750/780/785	4040
700/Hurricane/900/1050	4315

Yamaha	OEM#	Part No.
760	6M6-11351-A200	3205
650/701 All		2220
GP800	66E-11351-0000	3420
1100/1200	63M-11351-010	4415

Kawasaki	OEM#	Part No.
440 All		5240
550 80-90	11009-3782	5430
550 91-93	11009-3780	5635
650 All	11009-3775	5850
750 All	11060-3711	7040
900	11060-3752	7420
1100	11060-3760	7615



HEAD PIPE GASKET FOR AFTERMARKET

Factory Pipe	Part No.
Factory Pipe All (46.92mm ID)	5900
For Ported Manifold (50.69mm ID)	5900A
Factory Pipe 785 (Spec 1)	6155
Factory Pipe 785 (Spec 2)	6158
Factory Pipe Sea-Doo 650/720	9010
Factory Pipe Kaw 550 LTD Kit	9020

Coffman Pipe	Part No.
Coffman Pipe 550 Climax Kit	9020
Coffman 750 SX Rocket Mod	9030
Coffman 750 SS, XI, ST Rocket	7100A
Coffman 750 XI (Hurricane)	7105

RIVA Pipe	Part No.
RIVA WaveRaider (3 Hole)	9070
RIVA All Other (3 Hole)	9060

R&D Pipe	Part No.
R&D 3 Bolt	9080
R&D 4 Bolt	9090



HIGH PERFORMANCE COPPER BASE GASKETS

Kawasaki	Thickness	Part No.
800 SXR	.002" - .0508mm	7040.002
800 SXR	.003" - .0762mm	7040.003
800 SXR	.005" - .127mm	7040.005
800 SXR	.020" - 0.5mm	B0075020C

HIGH PERFORMANCE FIBER BASE GASKETS

Fiber base gaskets with a metal core.

Kawasaki	Thickness	Part No.
800 SXR	.030" - 0.75mm	7040C
800 SXR	.040" - 1.00mm	7040D
800 SXR	.050" - 1.25mm	7040E
800 SXR	.060" - 1.50mm	7040F
800 SXR	.065" - 1.65mm	7040G



CARBURETOR BASE GASKETS

Description	Fiber	Green
Mikuni 38mm	5030	9230
Mikuni 40mm	6107	9235
Mikuni 44mm	5460	9240
Mikuni 46mm	9245	9250
Mikuni 48mm	-----	9252
Mikuni 48mm (SD951 I Series)		6740
Mikuni 50mm	-----	9257
Keihin 42mm	9210	9220
Keihin 38mm	5660	9200
Keihin 40mm	7060	9205



R&D DOMINATOR BASE GASKETS

Yamaha	Thickness	Part No.
Superjet	.020" - 0.5mm	070-00020
Superjet	.040" - 1.0mm	070-00040
Superjet	.060" - 1.5mm	070-00060

Kawasaki	Thickness	Part No.
Kaw 750/800	.060" - 1.5mm	071-00060

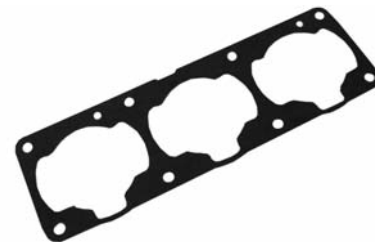

KAWASAKI 1100 BASE GASKETS

Solid aluminum core with high density fiber facing.

Kawasaki	Thickness	Part No.
1100 Base	.025" - .64mm	7615.025
1100 Base	.030" - .75mm	7615.030
1100 Base	.040" - 1.00mm	7615.040
1100 Base	.050" - 1.25mm	7615.050
1100 Base	.060" - 1.50mm	7615.060
1100 Base	.065" - 1.65mm	7615.065



CUSTOM MISCELLANEOUS RACE GASKETS



12-0010



8055

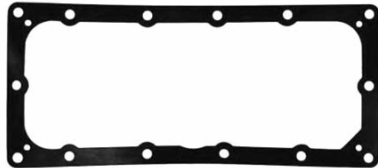

2116A

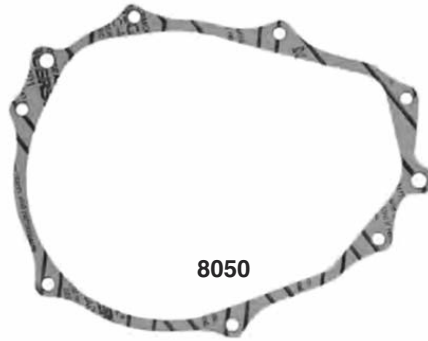

8050



9035

Description

Our Part#

R&D Mounting Plate Gasket for Dual Intake Manifold	12-0010
R&D Kawasaki Timing Advance Ignition Cover Gasket	8050
Kawasaki Twin Water High Flow Exhaust Gasket	9035
Yamaha 701/760 Reed Gasket for Aftermarket Reed Cages	8055
Yamaha Ignition Box Gasket	2116A

Yamaha Crankcase Application Chart

6M6	650LX, VXR, Wave Runner III, Super Jet 1990-93
61X	Pro VXR, Wave Runner III, GP, Super Jet 1994-95, FX-1, Wave Blaster 1993-95, Raider 701 1996-97
62T	Super Jet 1996-2001, Blaster II
64X	Wave Blaster 1996-97, GP760, Raider 701/Deluxe/760 1994-95, Venture 701/760, XL700/760
63M	Raider 1100, Venture 1100
66E	GP800 Power Valve
65U	GP1200, XL1200, SUV1200
66V	GP1200R, XL1200 LTD/XLT, 1999-2001 Power Valve

2016 Calendar

The world's most popular ski-only race series is undergoing a major change this 2016 season. Please stay tuned as we unveil our new series calendar as soon as possible. Check www.JetCrossTour.com



FACTORY PIPE GENUINE REPLACEMENT PARTS



ID	Length	Part No.
1-3/4"	5"	COMHOS0074
2"	2-1/2"	COMHOS0080
2-1/2"	2-3/4"	COMHOS0085*
3-1/2"	2-1/16"	COMHOS0090
3"	2-1/2"	COMHOS0091
2-1/4"	2"	COMHOS0092
2-1/2"	2-1/2"	COMHOS0094
4"	1-15/16"	COMHOS0101
4"	2-1/16"	COMHOS0100
5"	1-15/16"	COMHOS0111
5"	2-3/8"	COMHOS0110
5-1/2"	3"	COMHOS0150
3-3/4"	2"	COMHOS0701

*COMHOS0085 has been discontinued by Factory Pipe. These two parts listed below are replacement options for the COMHOS0085.

ID	Length	Color	Part No.
2-1/2"	3"	Blk	KOM-131-25CSBLK*
2-1/2"	3"	Blk	SIL000615*

*Requires cutting to match the length of Factory Pipe specifications.



FACTORY PIPE MOD BLASTER HOSE

Features a 90 degree angle in the hose
2.3875" ID waterbox side
2" ID pipe tailcone side

Description	Part No.
MOD Blaster	COMHOS0130



FACTORY PIPE SJ LIMITED HOSE

Features a 45 degree angle in the hose
2.3875" ID waterbox side
2" ID pipe tailcone side

Description	Part No.
96 701SJ LTD	COMHOS0135

TYPE	COUPLER	CLAMP	MOUNT
SEA-DOO			
580 SP 94-LATER	COMHOS0110 (5")	COMCLP0030	COMMNT0050
650 XP 93 & 95/96 SPX	COMHOS0110 (5")	COMCLP0030	COMMNT0050
650 GTX 94/95 & 96 580 GTS	COMHOS0110 (5")	COMCLP0030	COMMNT0050
650 & 720 XP 94/95	COMHOS0110 (5")	COMCLP0030	COMMNT0050
720 HX	COMHOS0110 (5")	COMCLP0030	COMMNT0050
720 GTI	COMHOS0110 (5")	COMCLP0030	COMMNT0050
785 XP/GSX/GTX SPEC I 95/96	COMHOS0150 (5.5")	COMCLP0080	
785 XP/GSX/GTX SPED II 95/96	COMHOS0150 (5.5")	COMCLP0080	
785 GSX/GTX/SPX SPEC I 97	COMHOS0150 (5.5")	COMCLP0080	
785 GSX/GTX/SPX SPEC II 97	COMHOS0150 (5.5")	COMCLP0080	
785 XP ONLY SPEC I 1997	COMHOS0150 (5.5")	COMCLP0080	
785 XP ONLY SPEC II 1997	COMHOS0150 (5.5")	COMCLP0080	
951XP / RX	COMHOS0701 (3.75")	—	COMMNT0052/54
YAMAHA			
650 SUPER JET	COMHOS0100 (4")	COMCLP0050	
650 WAVERUNNER III	COMHOS0100 (4")	COMCLP0050	
	COMHOS0085 (2.5")	—	
701 SUPER JET LIMITED 96-UP	COMHOS0100 (4")	COMCLP0050	
	COMHOS0135	—	
701 SUPER JET LIMITED	COMHOS0100 (4")	COMCLP0050	
701 SUPER JET MOD	COMHOS0100 (4")	COMCLP0050	
701 SUPER JET LTD/SS DRY PIPE	COMHOS0093 (3.5")	COMCLP0045	COMMNT0050/52
701 SUPER JET TYPE 8 DRY PIPE	COMHOS0093 (3.5")	COMCLP0045	COMMNT0052
701 SUPER JET TYPE 9 DRY PIPE	COMHOS0093 (3.5")	COMCLP0045	COMMNT0052
	COMHOS0080 (2.5")	COMCLP0021	
701 FX1	COMHOS0100 (4")	COMCLP0050	
701 WAVERUNNER III	COMHOS0100 (4")	COMCLP0050	
	COMHOS0080 (2")	COMCLP0020	
701 WAVEBLASTER LIMITED	COMHOS0100 (4")	COMCLP0050	COMMNT0050
	COMHOS0080 (2")	COMCLP0020	COMMNT0030
701 WAVEBLASTER MOD	COMHOS0100 (4")	COMCLP0050	COMMNT0030
	COMHOS0130	COMCLP0020	COMMNT0040
701 WAVEBLASTER	COMHOS0100 (4")	COMCLP0050	COMMNT0030
	COMHOS0080 (2")	COMCLP0020	COMMNT0040
760 GP/WAVEBLASTER II	COMHOS0090 (3.5")	COMCLP0040	COMMNT0030
800 GP TWIN	COMHOS0111 (5")	COMCLP0030	COMMNT0050/52
1200 GP TRIPLE	COMHOS0101 (4")	COMCLP0050	COMMNT0050/30
	COMHOS0111 (5")	COMCLP0030	COMMNT0052
1200 XL LTD/GP1200R TRIPLE			COMMNT0050/30
			COMMNT0052
KAWASAKI			
550 LIMITED 86/90	COMHOS0074 (1.75")	—	COMMNT0040
	COMHOS0100 (4")	COMCLP0050	
550 LIMITED 91/96	COMHOS0074 (1.75")	—	COMMNT0040
	COMHOS0100 (4")	COMCLP0050	
650 SX/X2 LIMITED	COMHOS0100 (4")	COMCLP0050	
650 SX/X2 MOD	COMHOS0100 (4")	COMCLP0050	
750 SS/XI	COMHOS0090 (3.5")	COMCLP0040	COMMNT0060
		COMCLP0020	
750 XIR	COMHOS0080 (2")	COMCLP0020	COMMNT0040
	COMHOS0100 (4")	COMCLP0050	
750 SX/SXI LIMITED	COMHOS0080 (2")	COMCLP0020	COMMNT0040
	COMHOS0100 (4")	COMCLP0050	
750 SX/SXI MOD	COMHOS0080 (2")	COMCLP0020	COMMNT0040
	COMHOS0100 (4")	COMCLP0050	
750 SXI DRY PIPE	COMHOS0701 (3.75")	—	COMMNT0052
800SXR DRY PIPE	COMHOS0701 (3.75")		COMMNT0052
	COMHOS0094 (2.5")		
800SXR WET PIPE	COMHOS0100 (4")	COMCLP0050	
1200 ULTRA/STX-R DRY PIPE	COMHOS0091 (3")	COMCLP0021	COMMNT0052
			COMMNT0030
POLARIS			
1050 SLTX TRIPLE	COMHOS0101 (4")	COMCLP0050	COMMNT0050/52



For Factory Pipe installation
instructions and parts lists.

FACTORY PIPE REPLACEMENT GASKETS AND O-RINGS

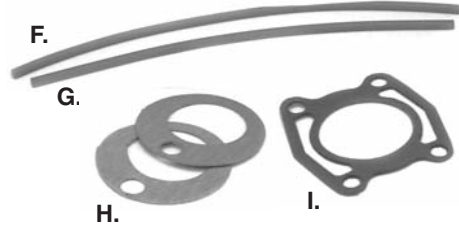
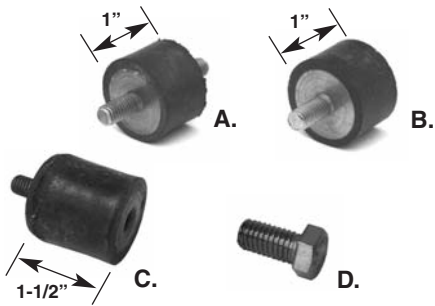

- A. K750SX/Blstr/Rdr **COMMNT0040**
- B. Blstr/Rdr **COMMNT0030**
- C. SJ Dry GP1200/800SXR **COMMNT0052***
- D. 3/8"-16 x 3/4" Hex Bolt **COMFAS0100***

*COMMNT0050 has been discontinued.
Use COMMNT0052 & COMFAS0100 as replacement part.

- | | | |
|------------------------------|------------------|------------|
| F. 14" Silicon Ring Chamber | (SD 580/650/720) | COMGAS0005 |
| G. 13" Silicon Ring Headpipe | (SD 580/650/720) | COMGAS0006 |
| H. Manifold/Headpipe Gasket | (SD 580/650/720) | COMGAS0070 |
| Headpipe/Manifold Gasket | SD785 Spec II | COMGAS0120 |
| I. Headpipe/Manifold Gasket | SD785 Spec I | COMGAS0110 |
| 246 Viton O-Ring | GP800 | COMGAS0170 |
| 337 Buna O-Ring | Super Jet Dry | COMGAS0235 |

FACTORY PIPE O-RING APPLICATION CHART

TYPE	O-RING NUMBER	O-RING DESCRIPTION	QTY
SEA-DOO			
580/650/720 ALL MODELS	COMGAS0005	14" SILICON RING	1
	COMGAS0006	13" SILICON RING	1
951 XP/XPL	COMGAS0235	337 BUNA O-RING (M)	2
	COMGAS0330	341 BUNA O-RING (L)	2
	COMGAS0340	344 BUNA O-RING (S)	2
YAMAHA			
701 SUPERJET DRY Type 4,8,9	COMGAS0235	337 BUNA O-RING	1
760 GP / WAVEBLASTER II	COMGAS0100	DISCONTINUED	2
800 GP TWIN	COMGAS0180	329 VITON O-RING	6
	COMGAS0170	246 VITON O-RING	1
1200 GP TRIPLE	COMGAS0180	329 VITON O-RING	9
	COMGAS0160	DISCONTINUED	2
	COMGAS0170	246 VITON O-RING	1
1200XL LTD / GP1200R TRIPLE	COMGAS0180	329 VITON O-RING	9
	COMGAS0150	7.5" GRAPHITE/KEVLAR	3
KAWASAKI			
750SX DRY PIPE	COMGAS0235	337 BUNA O-RING (M)	1
800SXR DRY PIPE	COMGAS0330	341 BUNA O-RING (L)	1
	COMGAS0340	344 BUNA O-RING (S)	1
STX-R TRIPLE	COMGAS0350	330 VITON O-RING	9
POLARIS			
1050 SLXH TRIPLE	COMGAS0180	329 VITON O-RING	9
1050 SLTX TRIPLE	COMGAS0180	329 VITON O-RING	9
MISCELLANEOUS			
ECWI FILTER BLOCK ASSY.	COMGAS0130	AS568A DASH#122	1

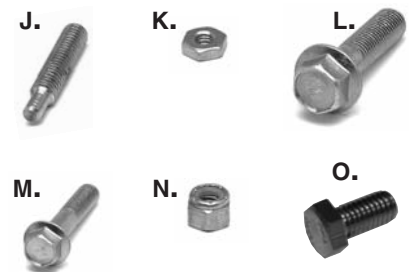

- | Factory Pipe | Part No. |
|---------------------------|------------|
| J. #10-32 Water Screw S/S | COMFAS0013 |
| K. #10-32 Nuts S/S | COMFAS0014 |
| L. 10mmX1.25X40 Bolt | COMFAS0050 |
| M. 10mmX1.25X50 Bolt | COMFAS0060 |
| N. 3/8"-16 S/S Nut | COMFAS0095 |
| O. 3/8"-16 x 3/4" Hex | COMFAS0100 |



- | Factory Pipe | Part No. |
|---|------------|
| P. KAW 800SXR Dry Pipe Head Bracket | COMBRK0228 |
| Q. Kaw 800SXR Inline Filter | COMFTG0036 |
| R. Kaw 800SXR Wet Pipe Air Temperature Bypass Connector | COMIGN0016 |



JET KIT WITH SPRING FOR FACTORY PIPE

Size	Part No.
5-1/2"	#600 COMCLP0080
5"	#88 COMCLP0030
4"	COMCLP0050
3-1/2" (High Torque)	#400 COMCLP0045
2"	#32 COMCLP0020

- | Description | Part No. |
|---|----------|
| For FIN701SJ02 with Stock Engine. Main Jet: 145 x 2, Pilot Jet: 120 x 2, Spring: 95gm x 2 | 52-4002 |
| For FIN701SJ03 with Stock Engine. Main Jet: 135 x 2, Pilot Jet: 70 x 2, Spring: 95gm x 2 | 52-4003 |

FOUR STROKE
INTAKE SYSTEMS
ENGINE/GASKETS
EXHAUST
DRIVE LINE HANDLING
ELECTRICAL
WATERLINE /BLGGE
STEERING & CONTROLS
BODY
ACCESSORIES
SERVICE TOOLS
HARDWARE
CHEMICAL



HEADPIPE SCREW REPAIR KIT FOR FACTORY PIPE

This kit is designed to replace the water adjustment set screws supplied with Factory Pipe products exhaust systems utilizing their tunable headpipe. This kit will fit exhaust systems: Yamaha B Pipe for SuperJets and Blasters Kawasaki 750SX, 650SX, and X2.

Description	Part No.
A. JP Engineering Headpipe BK Twister Screw Kit (<i>Standard size screws</i>)	BK-TWISTER
B. JP Engineering Headpipe Screw Repair Kit for Factory Pipe (<i>Oversize screws</i>)	JPE-KIT#2

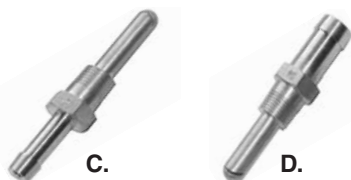

WATCON SPRAY NOZZLE FOR EXHAUST SYSTEMS

Description	Part No.
C. 1/8" NPT x 1/4" Hose Barb	SPRAY-1
D. 1/8" NPT x 3/8" Hose Barb	SPRAY-2



R&D EXHAUST SYSTEM REPLACEMENT PARTS

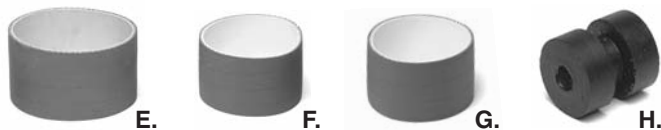

Description	Part No.
E. 5" ID x 3" L (Sea-Doo 785)	060-05003
F. 5" ID x 5" L	060-05005
G. 4.25" ID x 2.5" L (Super Jet Dry Pipe)	060-41425
H. Lord Mount	080-70102
R&D Super Jet Pipe O-ring Kit	080-70101



R&D HIGH TEMPERATURE SILICONE COUPLINGS

Description	Part No.
3"-3" High Temp Silicone Couplings	061-30030
3"-2" Reducer High Temp Silicone Couplings	061-32500
2.75"-2.5" Reducer High Temp Silicone Couplings	061-32501
3"-2.75" Reducer High Temp Silicone Couplings	061-32750

HIGH TEMP BLUE SILICONE EXHAUST HOSE SOLD IN 36" LENGTHS

This high temp blue silicone hose can be used for exhaust hose upgrades or replacement of OEM exhaust hoses. These exhaust hose lengths can also be used to make your own custom exhaust couplers.



36" = 91.44cm length

Inside Diameter	36" Length
1-3/4"	52-9004
2"	52-9005
2-1/4"	52-9008
2-1/2"	52-9010
3"	52-9006
3-1/2"	52-9015
4"	52-9011
4-1/2"	52-9012
5"	52-9014
5-1/2"	52-9017
6"	52-9018



T-BOLT CLAMPS

Size	Minimum Diameter		Max Diameter		Part No.
	Inch	mm	Inch	mm	
#238	2 15/64	56.7531	2 29/64	62.3094	D43H-75-238
#300	2 12/16	70.2564	3 1/16	77.7748	D40H-75-300
#325	3 5/32	80.1687	3 21/64	84.5344	D40H-75-325
#400	3 49/64	95.6469	4 1/6	105.833	D40H-75-400
#450	4 17/64	108.347	4 9/16	115.887	D40H-75-450
#500	4 49/64	115.887	5 1/16	128.587	D40H-75-500
#525	5 11/64	131.366	5 5/16	134.937	D40H-75-525
#550	5 17/64	133.747	5 9/16	141.287	D40H-75-550

All T-Bolt Clamps are 3/4" (.75mm) wide

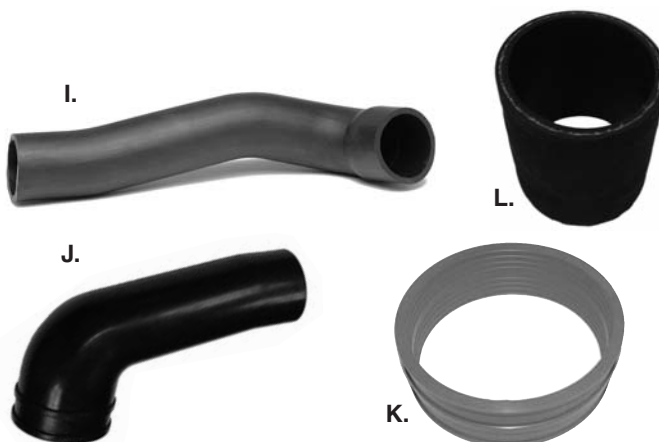

WSM REPLACEMENT EXHAUST HOSE

Yamaha	OEM No.	Part No.
I. 701 Wave Venture 95-96	63N-14752-30	011-500
J. GP 1200 97-99	65U-14752-00-00	011-501
K. 701/760/1100/1200	65T-14625-00	011-502

SEA-DOO	OEM No.	Part No.
L. GTI 06-07, GTX 06-07, RXP 06-07, RXT 06-07	274-001-302	011-425



EXHAUST BUSHINGS FOR SEA-DOO

SEA-DOO	OEM No.	Part No.
A. Exhaust Bushings. (95-06 GS, GTI, GTS, GTX, SP, SPI, SPX, XP) Sold in pairs.	293-830-031	011-515
B. Exhaust Bushing 650/720/800(SPX, XP97)/951(XP 2000-02, XPDI 2003-04, XP LTD 1998-99)	274-000-114	011-516
B. Exhaust Bushing 580/800 (GSX, GSX RFI, GTI LE, GTX, GTX RFI, SPX 1998, XP 1995-96, GSX LTD 1998), 951	274-000-254	011-515-02



REPLACEMENT EXHAUST DIFFUSER FOR KAWASAKI

Kawasaki	OEM No.	Part No.
C. 650SX (88-93), 650 X2 (87-94)	92059-3769	011-508
D. 650TS (89-96), 750XI (98-99) 750SS (92-97), 750 SXI (93-97)	92190-3712	011-510
E. 750 STS (96-97) 750 STX (98)	92191-3733	011-517
900 STX (97-98)	92093-3751	011-513



EXHAUST PIPE GROMMETS FOR PJS/WESTCOAST/COFFMAN'S KAWASAKI 550/650/750

Description	Part No.
Exhaust Pipe Grommets	52-4001

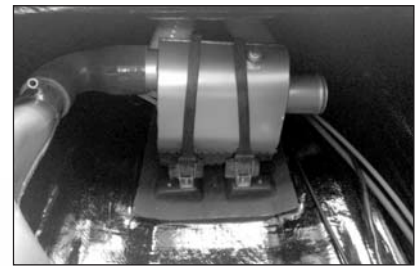

RRP WATERBOX

RRP performance aluminum waterbox for Rickters, Superjets (96+) and other aftermarket hull applications. Fits perfectly when used with a Factory "B" Pipe, installation requires Factory Pipe hose Part# COMHOS0130 as shown. The RRP waterbox features a 1/8" NPT water injection port to allow tuning of the exhaust to gain maximum performance while maintaining a quiet exhaust.

Description	Part No.
RRP Aluminum Waterbox	RRP-WTR-BOX



BLOWSION FREESTYLE DUAL EXHAUST KIT

Description	Part No.
Yamaha SuperJet 96+	01-01-553
Kawasaki 800 SXR	01-01-507
Yamaha Exhaust Splitter Only	01-01-555
Yamaha Side Exhaust Outlet	01-01-554



FUEL TANK BRACKET FOR SJ96+

This bracket attached on Super Jet Fuel Tanks utilizing OEM Fuel Tank Rubber Strap. Bracket holds MSD Water Control system (pre-drilled), Micro Touch Water Injection System and etc.

Yamaha	Part No.
Yamaha Superjet Fuel Tank Bracket	115849

CRAIG WARNER WINS THE 2015 HOT PRODUCTS LB2CAT, HIS 6TH TITLE. BOTH WARNER AND MARK GERNER CRUSHED THE PREVIOUS LB2CAT TIME RECORD! CRAIG WARNER 51 MINUTES, 21 SECONDS MARK GERNER 51 MINUTES, 52 SECONDS (BEATING PREVIOUS RECORD BY 3 MINUTES) PHOTO COURTESY OF MARK GERNER OF PWCOFFSHORE.COM.



FOUR STROKE
 INTAKE SYSTEMS
 ENGINE/GASKETS
 EXHAUST
 DRIVE LINE HANDLING
 ELECTRICAL
 WATERLINE /BILGE
 STEERING & CONTROLS
 BODY
 ACCESSORIES
 SERVICE TOOLS /HARDWARE
 CHEMICAL



WATCON EXHAUST FLANGE FOR FACTORY PIPE 550 LTD PIPE

The direct replacement for the exhaust flange on Factory Pipe 550 LTD.

Description	Part No.
Exhaust Flange for Factory Pipe 550 Ltd Pipe	550PF1
Factory Pipe K550 Ltd Pipe Gasket Kit	9020

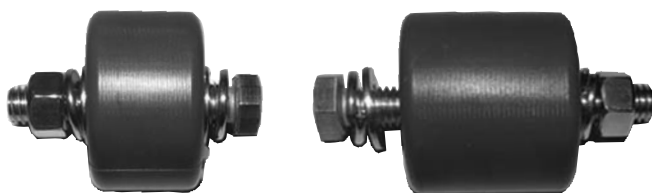

RHAAS URETHANE EXHAUST MOUNTS

Available for all models.

Description	Part No.
1" long	EXMOUNTSHT
1-1/2" long	EXMOUNTLNG



RIVA FREE FLOW EXHAUST KITS



Replaces the restrictive sound suppression system on GPR and XLT models. Provides reduced back-pressure that improves engine's performance and reduces harmful detonation. Easy installation with noticeable results. IJSBA Superstock legal.

Yamaha	Part No.
Free-Flow Exhaust Kit, GP800R/1200R	RY1620
Free-Flow Exhaust Kit GP1300R	RY1613
Free-Flow Exhaust Kit FX/FXHO (All Models)	RY1625



R&D D-PLATE FOR YAMAHA GP1200R/GP1300R, XLL/XLT1200

The new R&D D-Plate takes the place of the stock catalytic converter and delivers the best overall low, mid, peak and overall horsepower. The benefits include reducing engine compartment temperatures created by the catalytic converter and reliability of the complete stock exhaust assembly.

Competition use only. (CARB) California Air Resources Board emissions regulations prohibits sales of this product to California Dealers.

Description	Part No.
R&D D-Plate	332-12000



CAT TEMP SENSOR CHIP FOR YAMAHA GPR 1200 & 1300

Cat Temp Sensor Chip is a must when removing the OEM catalytic converter on Yamaha 1200 & 1300 Powervalue engines. The circuit is designed to mimic the signal sent to the OEM CDI by the catalytic converter's temperature probe preventing CDI, flutters, warning devices and engine shut downs due to cat removal. Can be used with stock or modified OEM CDIs. Plugs directly into factory wire harness.

Competition use only. (CARB) California Air Resources Board emissions regulations prohibits sales of this product to California Dealers.

Description	Part No.
RIVA Cat Temp Sensor Chip	RY115-20
Yamaha 1200/1300 Powervalue (66V/66T)	
R&D Cat Temp Sensor Chip	802-12001



R&D YAMAHA GP 1300R EXHAUST POWER SLEEVE

The R&D GP 1300R Exhaust Power Sleeve will add a serious boost to low end and mid range horsepower and performance! The R&D Exhaust Power Sleeve installs between the exhaust chamber and the catalytic housing to increase sonic wave energy! The R&D Exhaust power Sleeve will add the Y.P.V.S. (power valve) feel to the 2005 Yamaha's non-power valve engine!

Description	Part No.
Yamaha GP 1300R Exhaust Power Sleeve	332-13001



R&D KAWASAKI 800 SXR EXHAUST POWER SLEEVE

The new R&D billet aluminum Exhaust power Sleeve is designed to insert into the stinger of the stock exhaust to reduce the stinger size thereby increasing back pressure. This is a simple installation that will increase top speed and add 100 RPM.

Description	Part No.
Kawasaki 800 SXR Exhaust Power Sleeve	331-80000



R&D BILLET EXHAUST VALVES FOR GPR

The R&D Billet Exhaust Valves reduce the clearance between the valve and piston, this reduced clearance improves the seal which boosts the valve down compressions ratio delivering greater bottom and mid-range power. Directly replace OEM YPVS valve units.

Yamaha	Part No.
GP800/GP1200R Exhaust Valve Kit (each)	332-12002
Exhaust Valve Arm Only	332-12003
GP1300R Exhaust Valve Kit (each)	332-13000

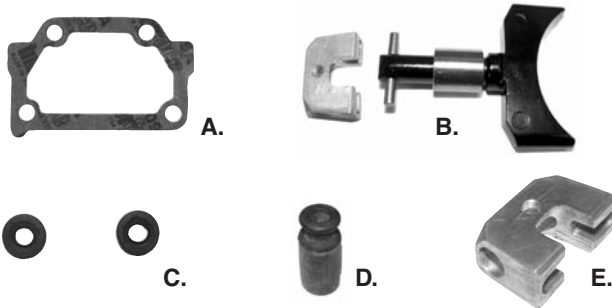

WSM REPLACEMENT EXHAUST VALVE PARTS FOR GPR800/1200/1300

Description	O.E. No.	Part No.
A. Housing Gasket	66E-1131B-01-00	007-590-02
B. Power Valve	60T-1131S-00-00	010-497-01
C. Oil Seal	93109-08M07-00	009-790
D. Joint Cover	66E-1131C-10-00	010-497-07
E. Safety Link	60T-11832-00-00	010-497-08
Valve Repair Complete Kit (A-E)		010-500K



WAVE EATER POWER VALVE RETAINER CLIP FOR YAMAHA GPR

Designed as an added measure of security when retaining the OEM Powervalves in Yamaha engines. Fitted clip prevents pin for moving and valve from dropping to low into valve guide. Special couplers better synchronize valve actuation through tighter tolerances and improved design.

Description	Part No.
Wave Eater Power Valve Retainer Clip Only	WE-CLIP
Sold Individually	
Wave Eater 2-Cylinder Kit	WE-800-KIT
Wave Eater 3-Cylinder Kit	WE-1200-KIT

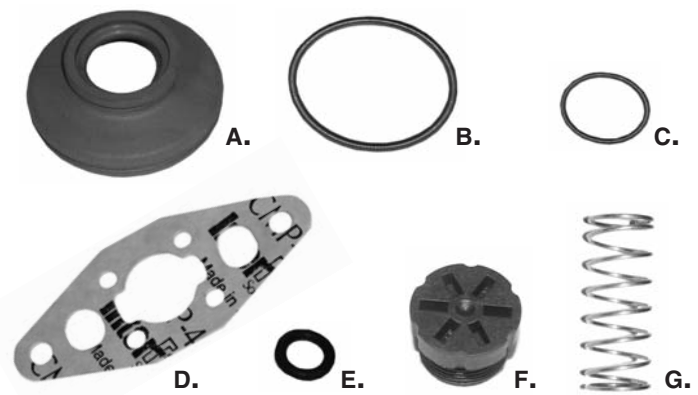

REPLACEMENT POWER VALVE PARTS FOR SEA-DOO

Description	OEM No.	Part No.
A. Power Valve Bellow	420-260-723	010-495-05
B. Power Valve Rubber Boot Spring (Large)	420-239.048	010-495-06
C. Power Valve Rubber Boot Spring (Small)	420-838.253	010-495-07
D. Power Valve Gasket	290-931-540	6618
E. Power Valve Stem O-Ring	290-430-110	6622
F. Adjustment Screw	290-244-220	010-495-27
G. Spring	290-939-137	010-028

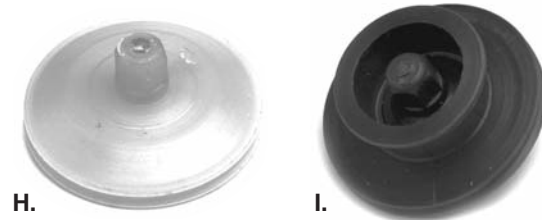

POWER VALVE PISTON FOR SEA-DOO

Description	OEM No.	Part No.
H. Fits All Engines with Power Valve	420-854-449	010-495-10
I. Sea-Doo Power Valve for use with Muffler PowerValve Assembly GSX (96-99), GTX (96-99), LRV (2000), SP (97), SPX (97-99), XP (96-99)	420-253-255	010-495-15



THE AWARD BANQUET AT THE 2015 HOT PRODUCTS IJSBA MARK HAHN MEMORIAL HAVASU 300 ENDURANCE RACE IN LAKE HAVASU CITY, ARIZONA.

FOUR STROKE
INTAKE SYSTEMS
ENGINE/GASKETS
EXHAUST
DRIVE LINE HANDLING
ELECTRICAL
WATERLINE /BILGE
STEERING & CONTROLS
BODY
ACCESSORIES SERVICE TOOLS /HARDWARE
CHEMICAL

FOUR STROKE
 INTAKE SYSTEMS
 ENGINE/ GASKETS
 EXHAUST
 DRIVE LINE HANDLING
 ELECTRICAL
 WATERLINE /BILGE
 STEERING & CONTROLS
 BODY
 SERVICE TOOLS ACCESSORIES
 SERVICE TOOLS ACCESSORIES /HARDWARE
 CHEMICAL

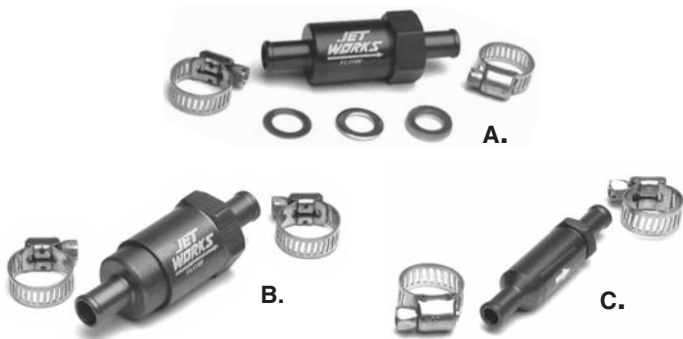

JETWORKS FLOW CONTROL VALVE

The Flow Control Valve provides improved throttle response and much quicker starts by drying out your waterbox at low rpm and idle speeds. Tests have shown an average acceleration improvement of 10 feet over a non-equipped model in the first 50 feet. The Flow Control Valve allows unrestricted water flow to the Stinger for better top speed. Yet it controls the amount of water at low speeds for better response. It also allows for an easier tuning of the Carburetors. It does not interfere with normal engine or exhaust pipe cooling and is compatible with all electronic water injection systems. Race Legal for All Classes. Two Models are available. Both are adjustable. The Standard Flow Control Valve is preset at 3.5 p.s.i. and is adjusted by adding the supplied stainless steel shims to increase the spring tension. The Pro-Series is externally adjustable by turning the outer housing by hand. Pressure can be tested with pop off gauge. All PWC w/OEM or aftermarket exhaust systems (except Yamaha's w/OEM exhaust)

Description	Color	Hose ID	Part No.
A. Standard Flow Control Valve	Red	3/8"	52-3118
B. Pro Flow Control Valve	Blue	3/8"	52-3119
C. Pro Flow Control Valve	Blue	1/4"	52-3122



JETWORKS RESTRICTOR

Includes 3 different sizes of restrictor inserts which allow you to adjust water flow.

Description	Color	Hose ID	Part No.
Jetworks Restrictor	Silver	3/8"	JW-WRK



JETWORKS QUICK DISCONNECT WATER RESTRICTOR

QD-38 comes with 4/3/2mm restrictor inserts used for controlling water flow through exit passes, stinger, head pipes, etc. QD-14 is for use with Mikuni Jets (not included), and allows quick change in small increments of water flow.

Description	Hose ID	Part No.
Quick Disconnect Water Restrictor	3/8"	QD-38
Quick Disconnect Water Restrictor	1/4"	QD-14



JET WORKS ADJUSTABLE WATER RESTRICTOR

Allows user to adjust flow on any 3/8" ID waterline. A great product for fine tuning engine/exhaust temperature for maximum power.

Description	Part No.
Adjustable Water Restrictor	JWR-01

RHAAS BILLET EXHAUST OUTLET

Description	Part No.
D. Kawasaki X2 (1986-93)	X2BILEXH
E. Kawasaki 550 (1986-89)	550BILEXH
F. Kawasaki X2 (1994-95)	X2BILEX2
G. Universal 2" Exhaust Outlet	2INCHEXH



MIKE FOLLMER SPEAKS AT THE 2015 HOT PRODUCTS IJSBA MARK HAHN MEMORIAL HAVASU 300 ENDURANCE RACE IN LAKE HAVASU CITY, ARIZONA.



Skat-Trak

Performance Products

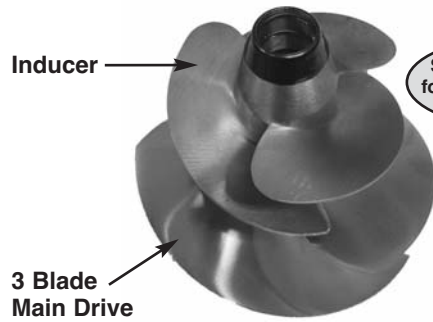

See Pages 174-175 for Flyboard Impeller Applications

SKAT-TRAK TWIN IMPELLERS

The new Twin Prop design drives of the line much quicker than the traditional single prop, and offers a substantial increase in rough water hookup.

FOUR STROKE
INTAKE SYSTEMS
ENGINE/GASKETS
EXHAUST
DRIVE LINE HANDLING
ELECTRICAL
WATERLINE /BILGE
STEERING & CONTROLS
BODY
ACCESSORIES SERVICE TOOLS
/HARDWARE
CHEMICAL

Sea-Doo RXP-X

*Must specify year when ordering Sea-Doo Twin Impeller

Engine Mods	Pitch	Part No.	Engine Mods	Pitch	Part No.
3 Blade Main Drive Stock	13/17	SS598328SWM1317	Inducer Stock	13/17	SS440ID1317
3 Blade Main Drive Limited	13/18	SS598328SWM1318	Inducer Limited	13/18	SS440ID1318
3 Blade Main Drive Supermod	15/20	SS598328SWM1520	Inducer Supermod	15/20	SS440ID1520

Sea-Doo RXT-X

*Must specify year when ordering Sea-Doo Twin Impeller

Engine Mods	Pitch	Part No.	Engine Mods	Pitch	Part No.
3 Blade Main Drive Stock	12/16	SS598328SWM1216	Inducer Stock	12/17	SS440ID1217
3 Blade Main Drive Limited	13/17	SS598328SWM1317	Inducer Limited	12/17	SS440ID1217
3 Blade Main Drive Supermod	15/18	SS598328SWM1518	Inducer Supermod	15/18	SS440ID1518

FX-SHO/FZR

Engine Mods	Pitch	Part No.	Engine Mods	Pitch	Part No.
3 Blade Main Drive Stock	12/18	SY557525SWM1218	Inducer Stock	12/17	SY440ID1217
3 Blade Main Drive Limited	12/20	SY557525SWM1220	Inducer Limited	12/17	SY440ID1217
3 Blade Main Drive Supermod	13/23	SY557525SWM1323	Inducer Supermod	14/18	SY440ID1418

ULTRA 250X/260X

Engine Mods	Pitch	Part No.	Engine Mods	Pitch	Part No.
3 Blade Main Drive Stock	12/18	SK557520SWM1218	Inducer Stock	12/17	SK440ID1217
3 Blade Main Drive Limited	12/20	SK557520SWM1220	Inducer Limited	12/17	SK440ID1217
3 Blade Main Drive Supermod	13/23	SK557520SWM1323	Inducer Supermod	14/18	SK440ID1418

ULTRA 300X

Engine Mods	Pitch	Part No.	Engine Mods	Pitch	Part No.
3 Blade Main Drive Stock	16/21	SK608320SWM1621	Inducer Stock	13/18	SK440ID1318
3 Blade Main Drive Limited	16/22	SK608320SWM1622	Inducer Limited	14/19	SK440ID1419
3 Blade Main Drive Supermod	16/23	SK608320SWM1623	Inducer Supermod	15/20	SK440ID1520

*See page 175 for inducer and main drive tools







WEST COAST ROUND
APRIL 16

EAST COAST ROUND
AUGUST 27

LAKE HAVASU CITY
ARIZONA

NORTH FORT MYERS
FLORIDA

#USFC2016 @PWCfreestyleUSA

www.PWCFREESTYLEUSA.com

ROUND 1
MAY 14
SO'FUN VILLAGE, FRANCE

ROUND 2
JUNE 11
LONDON, UK

ROUND 3
JULY 16
NYSA, POLAND

SUPER FINAL
JULY 17
NYSA, POLAND

#EFC2016 @PWCfreestyle

www.PWCFREESTYLE.eu



Skat-Trak
Performance Products

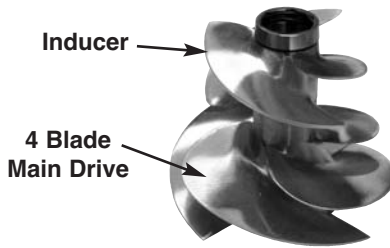

**FLYBOARD/JETLEV/JETOVATOR
4 BLADE MAIN DRIVE
TWIN IMPELLER**

Due to the complexity and variations required for these very specific applications, Skat-Trak is constantly adjusting and modifying the impeller recommendations. Please contact Hot Products for the updated information.

Model	Year	Engine CC	Pump Dia.	Recommended Skat-Trak Impeller			
				Main Drive	Req. Main Drive Tool	Inducer	Req. Inducer Tool
Sea-Doo Watercraft							
GTX Ltd 300	2016	1630 SCIC	161mm	SS618328SWM0918-4B	PWRSEASW28MD	SD440ID1417-4B	PWRINDHEX
RXT-X 300	2016	1630 SCIC	161mm	SS618328SWM0918-4B	PWRSEASW28MD	SD440ID1417-4B	PWRINDHEX
RXP-X 300	2016	1630 SCIC	161mm	SS618328SWM0918-4B	PWRSEASW28MD	SD440ID1417-4B	PWRINDHEX
RXP-X 255	2008-11	1494 SCIC	159.8mm	SS598328SWM0815-4B	PWRSEASW28MD	SS440ID1619	RWRINDHEX
RXP-X 260*	2010-14	1494 SCIC	159.8mm	SS598328SWM0815-4B	PWRSEASW28MD	SS440ID1619	RWRINDHEX
RXP 215*	2004-10	1494 SCIC	159.8mm	SS598328SWM0714-4B	PWRSEASW28MD	SS440ID1619	RWRINDHEX
RXP 155*	2007-08	1494	155.8mm	SS55832333SWM0815-4B	PWRSEASW23MD	SS440ID1619	RWRINDHEX
RXT 260	2011-16	1494 SCIC	159.8mm	SS598328SWM0815-4B	PWRSEASW28MD	SS440ID1619	RWRINDHEX
RXT aS 260	2011	1494 SCIC	159.8mm	SS598328SWM0815-4B	PWRSEASW28MD	SS440ID1619	RWRINDHEX
RXT-X 255	2008-10	1494 SCIC	159.8mm	SS598328SWM0815-4B	PWRSEASW28MD	SS440ID1619	RWRINDHEX
RXT-X 260	2011-15	1494 SCIC	159.8mm	SS598328SWM0815-4B	PWRSEASW28MD	SS440ID1619	RWRINDHEX
RXT-X aS 260	2012-16	1494 SCIC	159.8mm	SS598328SWM0815-4B	PWRSEASW28MD	SS440ID1619	RWRINDHEX
GTX 215*	2005-15	1494 SCIC	159.8mm	SS598328SWM0714-4B	PWRSEASW28MD	SS440ID1619	RWRINDHEX
GTX Ltd 215	2016	1494 SCIC	159.8mm	SS598328SWM0714-4B	PWRSEASW28MD	SD440ID1619	PWRINDHEX
GTX Ltd. 215*	2005-08	1494 SCIC	159.8mm	SS598328SWM0714-4B	PWRSEASW28MD	SS440ID1619	RWRINDHEX
RXT 215*	2005-10	1494 SCIC	159.8mm	SS598328SWM0712-4B	PWRSEASW28MD	SS440ID1619	RWRINDHEX
RXT iS 255	2009	1494 SCIC	159.8mm	SS598328SWM0714-4B	PWRSEASW28MD	SS440ID1619	RWRINDHEX
RXT iS 260	2010-12	1494 SCIC	159.8mm	SS598328SWM0714-4B	PWRSEASW28MD	SS440ID1619	RWRINDHEX
GTI Ltd 155	2016	1494 SCIC	155.8mm	SS55832333SWM0815-4B	PWRSEASW23MD	SD440ID1619	PWRINDHEX
Gti 130	2006-16	1494	155.8mm	SS55832333SWM0815-4B	PWRSEASW23MD	SS440ID1619	RWRINDHEX
Gti SE 130	2006-15	1494	155.8mm	SS55832333SWM0815-4B	PWRSEASW23MD	SS440ID1619	RWRINDHEX
Gti SE 155	2007-16	1494	155.8mm	SS55832333SWM0815-4B	PWRSEASW23MD	SS440ID1619	RWRINDHEX
GTS130	2011-16	1494 SCIC	155.8mm	SS55832333SWM0815-4B	PWRSEASW23MD	SD440ID1619	PWRINDHEX
GTX Ltd. IS 260	2010-16	1494 SCIC	159.8mm	SS598328SWM0815-4B	PWRSEASW28MD	SS440ID1619	RWRINDHEX
GTX 4-Tec	2002-04	1494	155.8mm	SS558323SWM0714-4B	PWRSEASW23MD	SS440ID1619	RWRINDHEX
GTX 4-Tec SC	2003-04	1494 SC	155.8mm	SS558323SWM0714-4B	PWRSEASW23MD	SS440ID1619	RWRINDHEX
GTX 4-Tec Tow	2003-04	1494	155.8mm	SS558323SWM0714-4B	PWRSEASW23MD	SS440ID1619	RWRINDHEX
GTX 155	2005-16	1494	155.8mm	SS55832333SWM0815-4B	PWRSEASW23MD	SS440ID1619	RWRINDHEX
GTX S 155	2012-15	1494	155.8mm	SS55832333SWM0815-4B	PWRSEASW23MD	SS440ID1619	RWRINDHEX
GTR 215	2012-16	1494 SCIC	159.8mm	SS598328SWM0815-4B	PWRSEASW28MD	SS440ID1619	RWRINDHEX
Wake 215	2007-16	1494 SCIC	159.8mm	SS598328SWM0714-4B	PWRSEASW28MD	SS440ID1619	RWRINDHEX
Wake 155	2005-16	1494	155.8mm	SS55832333SWM0815-4B	PWRSEASW23MD	SS440ID1619	RWRINDHEX
Spark**	2014-16	900	140mm	SS407530SWM1219-4B	RWRUNISWMD	SS440ID1318**	RWRVAMSPSHO

* MUST SPECIFY YEAR WHEN ORDERING SEA-DOO TWIN IMPELLERS

**3.500 O/D with spline not Hex

**SEA-DOO IMPELLER
APPLICATION 2004-2015**

In 2004, Sea-Doo released its 159.8mm pump system. This pump has been installed in the 215hp, 255hp, and 260hp Sea-Doo watercraft. Sea-Doo made a mid season change in the impeller and pump system in 2008. The 2004-2007 models all take the same style impeller. The 2009-2015 models all take the same style impeller.

Unfortunately, in 2008, there wasn't any rhyme or reason to which impeller and pump system was installed into a particular model Sea-Doo. We have seen the 2 different pumps in 2008 in the same model. This makes it very difficult to determine what style pump system is in a 2008 model 215hp, 255hp, or 260hp Sea-Doo.

Below are photos of the 2 different style pumps and impellers. This is the way to determine the difference between the 2.

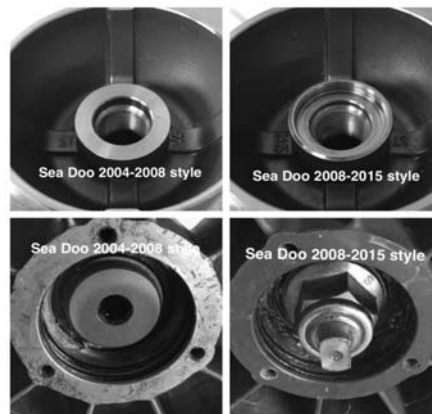

To determine the difference you will need to either remove the impeller and inspect the internal hub or remove the tail cone and inspect the impeller shaft. The images on the left are the 2004-2008 style impeller/pump system. The images on the right are the 2008-2015 impeller/pump system.

When ordering replacement impellers for the 2008 model Sea-Doo's with the 159.8mm pump, we need to know which style impeller you need. Please inspect your impeller/pump prior to ordering. This information is crucial to ensure that you get the correct impeller for your 2008 Sea-Doo application.

Model	Year	Engine CC	Pump Dia.	Recommended Skat-Trak Impeller			
				Main Drive	Req. Main Drive Tool	Inducer	Req. Inducer Tool
Yamaha							
FZR SVHO	2014-16	1812	160mm	SY608325-2SWM0815-4B	RWRVAMDSSHO	SY440ID1619	RWRVAMSPSHO
FZS SVHO	2014-16	1812	160mm	SY608325-2SWM0815-4B	RWRVAMDSSHO	SY440ID1619	RWRVAMSPSHO
FX SVHO	2014-16	1812	160mm	SY608325-2SWM0815-4B	RWRVAMDSSHO	SY440ID1619	RWRVAMSPSHO
FX Cruiser SVHO	2014-16	1812	160mm	SY608325-2SWM0815-4B	RWRVAMDSSHO	SY440ID1619	RWRVAMSPSHO
FZR	2009-13	1812	155mm	SY558325SWM0816-4B	RWRVAMDSSHO	SY440ID1619	RWRVAMSPSHO
FZS	2009-13	1812	155mm	SY558325SWM0816-4B	RWRVAMDSSHO	SY440ID1619	RWRVAMSPSHO
VXS	2012-16	1812	155mm	SY558325SWM0815-4B	RWRVAMDSSHO	SY440ID1619	RWRVAMSPSHO
VXR	2012-16	1812	155mm	SY558325SWM0815-4B	RWRVAMDSSHO	SY440ID1619	RWRVAMSPSHO
VX 110	2015-16	1052	155mm	SY558320KYSWM1221-4B	RWRUNISWMD	SY440ID1619	RWRVAMSPSHO
VX 110	2005-09	1052	155mm	SY558320KYSWM1221-4B	RWRUNISWMD	SY440ID1619	RWRVAMSPSHO
VX Deluxe	2005-16	1052	155mm	SY558320KYSWM1221-4B	RWRUNISWMD	SY440ID1619	RWRVAMSPSHO
VX Sport	2005-13	1052	155mm	SY558320KYSWM1221-4B	RWRUNISWMD	SY440ID1619	RWRVAMSPSHO
VX Cruiser	2007-16	1052	155mm	SY558320KYSWM1221-4B	RWRUNISWMD	SY440ID1619	RWRVAMSPSHO
VX Cruiser HO	2016	1812	155mm	SY558325SWM0815-4B	RWRVAMDSSHO	SY440ID1619	RWRVAMSPSHO
VX Limited	2016	1052	155mm	SY558325SWM0815-4B	RWRVAMDSSHO	SY440ID1619	RWRVAMSPSHO
FX SHO	2008-15	1812	155mm	SY558325SWM0815-4B	RWRVAMDSSHO	SY440ID1619	RWRVAMSPSHO
FX Cruiser SHO	2008-16	1812	155mm	SY558325SWM0815-4B	RWRVAMDSSHO	SY440ID1619	RWRVAMSPSHO
FX Cruiser HO	2016	1812	155mm	SY558325SWM0815-4B	RWRVAMDSSHO	SY440ID1619	RWRVAMSPSHO
FX HO	2015-16	1812	155mm	SY558325SWM0815-4B	RWRVAMDSSHO	SY440ID1619	RWRVAMSPSHO
FX HO	2009-13	1812	155mm	SY558325SWM0815-4B	RWRVAMDSSHO	SY440ID1619	RWRVAMSPSHO
(non supercharge)							
FX HO 1812cc	2008	1812	155mm	SY558325SWM0815-4B	RWRVAMDSSHO	SY440ID1619	RWRVAMSPSHO
FX HO 1050cc	2008	1050	155mm	SY558322SWM0815-4B	RWRVAMSUVDS	SY440ID1619	RWRVAMSPSHO
FX HO	2004-07	1050	155mm	SY558322SWM0815-4B	RWRVAMSUVDS	SY440ID1619	RWRVAMSPSHO
GP1300R	2003-08	1296	155mm	SY558322SWM1018-4B	RWRVAMSUVDS	SY440ID1619	RWRVAMSPSHO
AR230HO	2005-07	Twin 998	155mm	SY558322SWM0815-4B	RWRVAMSUVDS	SY440ID1619	RWRVAMSPSHO

Kawasaki Watercraft

310 X	2014-16	1498 SCIC	160mm	SK608320-2SWM0714-4B*	PWRUNISWMD	SK440ID1619	RWRVAMSPSHO
310 LX	2014-16	1498 SCIC	160mm	SK608320-2SWM0714-4B*	PWRUNISWMD	SK440ID1619	RWRVAMSPSHO
310 R	2014-16	1498 SCIC	160mm	SK608320-2SWM0714-4B*	PWRUNISWMD	SK440ID1619	RWRVAMSPSHO
310 X SE	2015-16	1498 SCIC	160mm	SK608320-2SWM0714-4B*	PWRUNISWMD	SK440ID1619	RWRVAMSPSHO
310 LX	2015-16	1498 SCIC	160mm	SK608320-2SWM0714-4B*	PWRUNISWMD	SK440ID1619	RWRVAMSPSHO
300 X	2011-13	1498 SCIC	160mm	SK608320SWM0714-4B	PWRUNISWMD	SK440ID1619	RWRVAMSPSHO
300 LX	2011-13	1498 SCIC	160mm	SK608320SWM0712-4B	PWRUNISWMD	SK440ID1619	RWRVAMSPSHO
260 X	2009-13	1498 SCIC	155mm	SK558320SWM0714-4B	PWRUNISWMD	SK440ID1619	RWRVAMSPSHO
260 LX	2009-13	1498 SCIC	155mm	SK558320SWM0712-4B	PWRUNISWMD	SK440ID1619	RWRVAMSPSHO
250 X	2007-08	1498 SCIC	155mm	SK558320SWM0714-4B	PWRUNISWMD	SK440ID1619	RWRVAMSPSHO
250 LX	2007-08	1498 SCIC	155mm	SK558320SWM0712-4B	PWRUNISWMD	SK440ID1619	RWRVAMSPSHO
STX 15F	2004-16	1498	148mm	SK488320SWM0815-4B	PWRUNISWMD	SK440ID1518	RWRVAMSPSHO
STX 12F	2004-08	1498	148mm	SK488320SWM0815-4B	PWRUNISWMD	SK440ID1518	RWRVAMSPSHO

* Ultra 310 has different machining

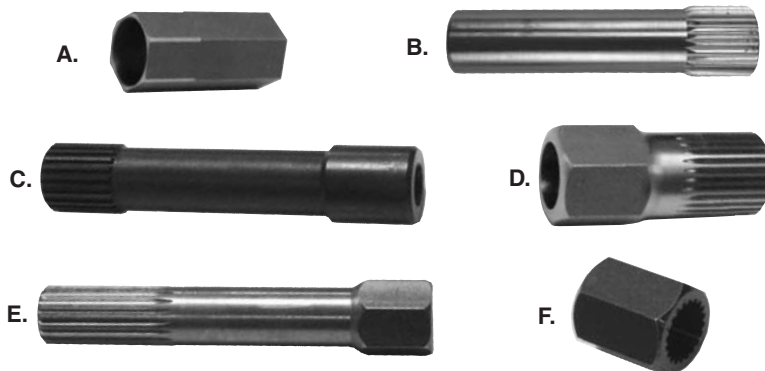

SKAT-TRAK TWIN IMPELLERS TOOL

Skat-Trak Twin Impellers require special tools to assemble and install Skat-Trak Twin Impellers, standard impeller tools will not work. *Skat-Trak Twin Impeller tools are not included when you order Skat-Trak Twin Impellers, they are sold separately.*

Description	Part No.
A. Inducer 1.25" Hex Tool	PWRINDHEX
B. Sea-Doo Main Drive 28mm Spline Wrench	RWRSEASW28MD
C. Sea-Doo Main Drive 23mm Spline Wrench	RWRSEASW23MD
D. Yamaha 25mm Spline Installation Tool	RWRVAMSPSHO
E. Kaw/SD/Hon Universal Main Drive 20mm Spline Wrench	RWRUNISWMD
F. Yamaha SHO 25mm Drive Shaft Wrench	RWRVAMDSSHO

FOUR
STROKE
INTAKE
SYSTEMS
ENGINE/
GASKETS
EXHAUST
DRIVE LINE
HANDLING
ELECTRICAL
WATERLINE
/BILGE
STEERING
& CONTROLS
BODY
ACCESSORIES
SERVICE TOOLS
/HARDWARE
CHEMICAL

RECOMMENDED SKAT-TRAK IMPELLER

	Model	Year	Engine	Orig. Imp.	Pump Dia.	Stock Engine	Limited Engine	Modified Engine	
FOUR STROKE	RXT-X 300	2016	1630 SCIC	n/a	161mm	SS618328SW31519	Call for application	Call for application	
	RXP-X 300	2016	1630 SCIC	n/a	161mm	SS618328SW31519	Call for application	Call for application	
	GTX Ltd 300	2016	1630 SCIC	n/a	161mm	SS618328SW31519	Call for application	Call for application	
	RXP-X 255	08-11	1494 SC	n/a	159.8mm	SS598328SW31419	SS598328SW31420	Call for application	
	RXP-X 260	10-14	1494 SC	n/a	159.8mm	SS598328SW31419	SS598328SW31420	Call for application	
	RXT 215	05-10	1494 SC	n/a	159.8mm	SS598328SW31317	SS598328SW31418	Call for application	
	RXP 215	04-10	1494 SC	n/a	159.8mm	SS598328SW31318	SS598328SW31419	Call for application	
	RXP 155	07-08	1494	n/a	155.8mm	SS55832333SW1317.5	SS55832333SW1318	Call for application	
	RXT 260	11-16	1494 SC	n/a	159.8mm	SS598328SW31419	SS598328SW31420	Call for application	
	RXT aS 260	2011	1494 SC	n/a	159.8mm	SS598328SW31419	SS598328SW31420	Call for application	
	RXT-X 260	11-15	1494 SC	n/a	159.8mm	SS598328SW31419	SS598328SW31420	Call for application	
INTAKE SYSTEMS	RXT-X aS 260	12-16	1494	n/a	159.8mm	SS598328SW31419	SS598328SW31420	SS598328SW31520	
	RXT-X 255	08-10	1494 SC	n/a	159.8mm	SS598328SW31318	SS598328SW31419	Call for application	
	RXT iS 255	2009	1494 SC	n/a	159.8mm	SS598328SW31318	SS598328SW31419	Call for application	
	RXT iS 260	10-12	1494 SC	n/a	159.8	SS598328SW31318	SS598328SW31419	Call for application	
	ENGINE/ GASKETS	RXX	01	951	16/23 D-75 Mag	148mm	SSD75SW1623	SSD75SW1624	SSD75SW1625
		RX Di	00-04	951	n/a	155.5mm	SS5583SW1319	SS5583SW1320	SS5583SW1321
		RX	00-02	951	n/a	155.5mm	SS5583SW1319	SS5583SW1320	SS5583SW1321
		LRV DI	02-04	951	n/a	155.5mm	SS5583SW1418	SS5583SW1319	SS5583SW1320
		LRV	00-01	951	n/a	155.5mm	SS5583SW1418	SS5583SW1319	SS5583SW1320
		3D DI	06-07	951	n/a	155.5mm	SS5583SW1319	Call for application	Call for application
		3D Base	2005	800	n/a	155.5mm	SS5583SW1016	Call for application	Call for application
3D Premium		2005	800	n/a	155.5mm	SS5583SW1016	Call for application	Call for application	
Spark		14-16	900	n/a	140mm	SS407530SW1214	Call for application	Call for application	
XP Di		03-04	951	n/a	155.5mm	SS5583SW1320	SS5583SW1321	Call for application	
XP Ltd.		98-02	951	13/21	155.5mm	SS5583SW1321	SS5583SW1321	SS55831322	
EXHAUST SYSTEMS	XP 800	97	800	16/23	140mm	*SSSW1722 or SSSS1726**	*SSSW1723 or SSSS1726**	*SSSW1724B or SSSS17.527**	
		95-96	800	17/25	140mm	*SSSW1722 or SSSS1726**	*SSSW1723 or SSSS1726**	*SSSW1724B or SSSS17.527**	
	DRIVE LINE HANDLING	XP	95	720	10/22	140mm	*SSSW1621 or SSSL1520**	SSSW14.522.5	SSSW1722 to SSSW1724B
			94	650	16/24	140mm	*SSSW1520 or SSSL1419**	*SSSW1520 or SSSL1419**	*SSSW1621 or SSSL1520**
			93	650	15/20.5	140mm	*SSSW1419 or SSSL1318**	*SSSW1520 or SSSL1419**	*SSSW1621 or SSSL1520**
			91-92	580	19	140mm	SSSL1318	*SSSL1318 or SSSL1419**	SSSL1419 to SSSL1621
	ELECTRICAL	GSX Ltd.	98-99	951	16/21	155.5mm	SS5583SW1320	SS5583SW1320	SS5583SW1321
			97 1/2	951	n/a	155.5mm	SS55SS1418	SS55SS1418	SS55SS1419
		GSX RFI	99-01	800	12/25	140mm	SS4075SW1621	SS4075SW1622	SS4075SW1623
	WATERLINE /BILGE	GSX	96-97	800	17/24,16/23	140mm	*SSSW1722 or SSSS1625**	*SSSW1723 or SSSS1726**	*SSSW1724B or SSSS17.527**
		GSi	97	720	11/22	140mm	*SSSW1621 or SSSL1520**	SSSW14.522.5	SSSW1722 to SSSW1724B
GS		98-01	720	11/22, 14/21	140mm	SSSW1520	SSSW1621	SSSW14.522.5	
		97	720	10/35 al	140mm	*SSSW1621 or SSSL1520**	SSSW14.522.5	SSSW1722 to SSSW1724B	
HX		95-97	720	10/22,11/24	140mm	*SSSW1621 or SSSL1520**	SSSW14.522.5	SSSW1722 to SSSW1724B	

* Suggested for maximum bottom-to-mid range acceleration gains. ** Suggested for maximum top speed gains. NOTE: 17/24B is **NOT** as aggressive as the original 17/24 swirl impeller. Refer to the IJSBA Rulebook for a more detailed definition of "stock, Limited, and Modified."

SKAT-TRAK IMPELLER DESIGNS AND PITCHES AVAILABLE

SWIRL

PITCH	PART NUMBER
12/17	SSSW1217
13/18	SSSW1318
14/19	SSSW1419
15/20	SSSW1520
16/21	SSSW1621
14.5/22.5	SSSW14.522.5
16/23	SSSW1623
16/24	SSSW1624
16/25	SSSW1625
17/22	SSSW1722
17/23	SSSW1723
17/24B	SSSW1724B
17/24	SSSW1724

140-75 SWIRL

PITCH	PART NUMBER
16/21	SS4075SW1621
16/22	SS4075SW1622
16/23	SS4075SW1623

SSL

PITCH	PART NUMBER
16/25	SSSS1625
17/26	SSSS1726
17.5/27	SSSS17.527

159-83-28 3-BLADE SWIRL SUPER PRO

PITCH	PART NUMBER
13/17	SS598328SW31317
13/18	SS598328SW31318
14/19	SS598328SW31419
14/20	SS598328SW31420
15/18	SS598328SW31518
15/19	SS598328SW31519
15/20	SS598328SW31520
15.5/21.5	SS598328SW3155215

155-83 SWIRL

PITCH	PART NUMBER
10/16	SS5583SW1016
11/17	SS5583SW1117
13/18	SS5583SW1318
13/19	SS5583SW1319
13/20	SS5583SW1320
13/21	SS5583SW1321
13/22	SS5583SW1322
14/18	SS5583SW1418

155-83 SSL

PITCH	PART NUMBER
13/19	SS5583SS1319
13/20	SS5583SS1320
13/21	SS5583SS1321

155 SSL

PITCH	PART NUMBER
14/18	SS55SS1418
14/19	SS55SS1419

140-75-30 SWIRL

PITCH	PART NUMBER
12/14	SS407530SW1214



RECOMMENDED SKAT-TRAK IMPELLER

Model	Year	Engine	Orig. Imp.	Pump Dia.	Stock Engine	Limited Engine	Modified Engine
SPX	97-99	800	16/24, 16/23	140mm	*SSSW1722 or SSSS1726*	SSSW1723/SSSS1726	*SSSW1724B or SSSS17.527
	96	720	11/24	140mm	*SSSW1621 or SSSL1520*	SSSW14.522.5	SSSW1722 to SSSW1724B
	95	650	11/21	140mm	*SSSW1520 or SSSL1419*	*SSSW1520 or SSSL1419**	*SSSW1621 or SSSL1520**
	94	650	14/21.5	140mm	*SSSW1419 or SSSL1318*	*SSSW1520 or SSSL1419**	*SSSW1621 or SSSL1520**
	93	580	16/20.5	140mm	SSSL1318	*SSSL1318 or SSSL1419**	SSSL1419 to SSSL1621
SPi	94-96	580	14/21	140mm	SSSL1318	*SSSL1318 or SSSL1419**	SSSL1419 to SSSL1621
	93	580	17.7	140mm	SSSL1318	*SSSL1318 or SSSL1419**	SSSL1419 to SSSL1621
SP	97	720	16/35 al	140mm	SSSW1520/SSSL1419	SSSW14.522.5	SSSW1722 to SSSW1724B
	88-96	580	18.8 al	140mm	SSSL1318	*SSSL1318 or SSSL1419**	SSSL1419 to SSSL1621
GTR 215	12-16	1494	n/a	159.8mm	SS598328SW31318	Call for application	Call for application
GTX 4-Tec	02-04	1494	n/a	155.8mm	SS558323SW1520	SS558323SW1621	Call for application
4-Tec SC	03-04	1494 SC	n/a	155.8mm	SS558323SW1621	Call for application	Call for application
4-Tec Tow	03-04	1494	n/a	155.8mm	SS558323SW1520	SS558323SW1621	Call for application
WAKE 155	05-16	1494	n/a	155.8mm	SS558323SW1520	Call for application	Call for application
WAKE 215	07-16	1494 SC	n/a	159.8mm	SS598328SW313175	Call for application	Call for application
GTX S 155	12-15	1494	n/a	155.8mm	SS55832333SW1216	Call for application	Call for application
GTX DI	00-03	951	n/a	155.5mm	*SS5583SW1319 or SS5583SW1418**	SS5583SW1320	SS5583SW1321
GTX Ltd. 215	2016	1494 SCIC	n/a	159.8mm	SS598328SW31317	Call for application	Call for application
GTX Ltd. 215	05-08	1494 SC	n/a	159.8mm	SS5959832831317	Call for application	Call for application
GTX Ltd.	98-02	951	13/21	155.5mm	SS5583SW1319	SS5983SW1319	SS5583SW1321
GTX RFI	98-02	800	16/24, 12/25	140mm	SS4075SW1622	SS4075SW1623	SS4075SW1623
GTX iS 255	2009	1494 SC	n/a	159.8mm	SS598328SW31318	Call for application	Call for application
GTX SC 215	05-12	1494 SC	n/a	159.8	SS59832833SW31317	Call for application	Call for application
GTX 215	05-13	1494 SC/C	n/a	159.8mm	SS598328SW31317	Call for application	Call for application
GTX 155	05-13	1494	n/a	155.8mm	SS558323SW1520	Call for application	Call for application
GTX iS 255	2009	1494 SC	n/a	159.8mm	SS598328SW31318	Call for application	Call for application
GTX Ltd iS 260	10-16	1494 SC	n/a	159.8mm	SS598328SW31318	Call for application	Call for application
GTX iS 215	2011	1494 SC	n/a	159.8mm	SS598328SW31318	Call for application	Call for application
GTX 215	05-15	1494 SCIC	n/a	159.8mm	SS598328SW31317	Call for application	Call for application
GTX 155	05-16	1494	n/a	155.8mm	SS558323SW1520	Call for application	Call for application
GTX	96-97	800	17/25, 12/24	140mm	*SSSW1722 or SSSS1625**	*SSSW1723 or SSSS1726	*SSSW1724B or SSSS17.527**
	95	650	10/22	140mm	*SSSW1520 or SSSL1419**	*SSSW1520 or SSSL1419	*SSSW1621 or SSSL1520**
	94	650	15/20	140mm	*SSSW1419 or SSSL1318**	*SSSW1520 or SSSL1419	*SSSW1621 or SSSL1520**
	92-93	580	18.3	140mm	SSSL1318	*SSSL1318 or SSSL1419	*SSSL1419 or SSSL1621**
Gti LE RFI	03-04	800	n/a	155.5mm	SS5583SW1016	SS5583SW1117	Call for application
Gti LE	02-05	720	n/a	155.5 mm	SS5583SW1016	*SS5583SW1016 or SS5583SW1117**	Call for application
Gti RFI	04-05	800	n/a	155.5mm	SS5583SW1016	SS5583SW1117	Call for application
Gti SE 130	06-15	1494	n/a	155.8mm	SS55832333SW1215	Call for application	Call for application
Gti 130	06-16	1494	n/a	155.8mm	SS55832333SW1215	Call for application	Call for application
Gti SE 155	07-16	1494	n/a	155.8mm	SS55832333SW1215	Call for application	Call for application
Gti Ltd 155	11-16	1494	n/a	155.5mm	SS55832333SW1216	Call for application	Call for application
Gti	02-05	720	n/a	155.5 mm	SS5583SW1016	*SS5583SW1016 or SS5583SW1117**	Call for application
	99-01	720	n/a	140mm	SS4075SW1621	SS4075SW1622	Call for application
	96-98	720	11/24, 11/22	140mm	*SSSW1621 or SSSL1520**	SSSW14.522.5	SSSW1722 to SSSW1724B
GTS 130	11-16	1494	n/a	155.5mm	SS55832333SW1215	Call for application	Call for application
GTS	01-02	720	n/a	155.5mm	SS5583SW1016	SS5583SW1117	Call for application
	97-00	720	11/22	140mm	*SSSW1621 or SSSL1520**	SSSW14.522.5	SSSW1722 to SSSW1724B
	94-96	580	14/21, 15/21, 10/25	140mm	SSSL1318	*SSSL1318 or SSSL1419**	SSSL1419 to SSSL1621
	92-93	580	17	140mm	SSSL1318	*SSSL1318 or SSSL1419**	SSSL1419 to SSSL1621
GT	90-91	580	17 al	140mm	SSSL1318	*SSSL1318 or SSSL1419**	SSSL1419 to SSSL1621

* Suggested for maximum bottom-to-mid range acceleration gains. ** Suggested for maximum top speed gains. NOTE: 17/24B is **NOT** as aggressive as the original 17/24 swirl impeller. Refer to the IJSBA Rulebook for a more detailed definition of "stock, Limited, and Modified."

SLIM LINE

PITCH	PART NUMBER
12/17	SSSL1217
13/18	SSSL1318
14/19	SSSL1419
15/20	SSSL1520
16/21	SSSL1621
17/22	SSSL1722

155-83-23 SWIRL

PITCH	PART NUMBER
15/20	SS558323SW1520
16/21	SS558323SW1621

155-83-23-33 3 BLADE SWIRL WITH BILLET 22-33 NOSE BOOT

PITCH	PART NUMBER
12/15	SS55832333SW1215
13/17.5	SS55832333SW13175

PLEASE SPECIFY EXACT YEAR WHEN ORDERING A SEA-DOO IMPELLER FOR MODELS PRODUCED FROM 2007-09. SEE PAGE 174

FOUR STROKE
INTAKE SYSTEMS
ENGINE/GASKETS
EXHAUST
DRIVE LINE HANDLING
ELECTRICAL
WATERLINE /BILGE
STEERING & CONTROLS
BODY
ACCESSORIES SERVICE TOOLS /HARDWARE
CHEMICAL

RECOMMENDED SKAT-TRAK IMPELLER

Model	Year	Engine	Orig. Imp.	Pump Dia.	Stock Engine	Limited Engine	Modified Engine
SUV 1200	99-04	1131	15.2	155mm	SY55XLSW1218R	*SY55XLSW1218R or SY55XLSW1319R**	SY55XLSW1319R
FX SVHO	14-16	1812	n/a	160mm	SY607525-2SW1321	SY607525-2SW1322	SY607525-2SW1323
FX Cruiser SVHO	14-16	1812	n/a	160mm	SY607525-2SW1320	SY607525-2SW1321	SY607525-2SW1322
FZR SVHO	14-16	1812	n/a	160mm	SY607525-2SW1321	SY607525-2SW1322	SY607525-2SW1323
FZS SVHO	14-16	1812	n/a	160mm	SY607525-2SW1321	SY607525-2SW1322	SY607525-2SW1323
FZR	09-13	1812	n/a	155mm	SY557525SW1220	Call for application	Call for application
FZS	09-13	1812	n/a	155mm	SY557525SW1119	Call for application	Call for application
VXS	12-16	1812	10/17	155mm	SY557525SW1118	SY557525SW1219	SY557525SW1320
VXR	12-16	1812	10/17	155mm	SY557525SW1118	SY557525SW1219	SY557525SW1320
VX	05-09	1052	n/a	155mm	SY55KYSW1624	Call for application	Call for application
VX	15-16	1052	n/a	155mm	SY55KYSW1523	Call for application	Call for application
VX Deluxe	05-16	1052	21.2	155mm	SY55KYSW1523	Call for application	Call for application
VX Sport	05-13	1052	21.2	155mm	SY55KYSW1523	Call for application	Call for application
VX Cruiser	07-16	1052	n/a	155mm	SY55KYSW1523	Call for application	Call for application
VX Cruiser HO	2016	1812	n/a	155mm	SY557525SW1319	Call for application	Call for application
VX Limited	2016	1052	n/a	155mm	SY557525SW1623	Call for application	Call for application
FX SHO	08-15	1812	n/a	155mm	SY557525SW1319	SY557525SW1320	SY557525SW1321
FX Cruiser SHO	08-16	1812	n/a	155mm	SY557525SW1319	SY557525SW1320	SY557525SW1321
FX HO	15-16	1812	n/a	155mm	SY557525SW1319	SY557525SW1320	SY557525SW1321
FX HO	09-13	1812	n/a	155mm	SY557525SW1319	SY557525SW1320	SY557525SW1321
FX HO 1812cc	2008	1812	n/a	155mm	SY557525SW1319	SY557525SW1320	SY557525SW1321
FX HO 1052cc	2008	1052	n/a	155mm	SY55XLMWSW1623	Call for application	Call for application
FX H.O.	04-07	1052	16.8	155mm	SY557522SW1623	Call for application	Call for application
FX-140	02-08	998	16.3	155mm	SY55XLSW1319R	*SY55XLSW1319R or SY55XLSW1420R**	Call for application
FX Cruiser	2006	1052	n/a	155mm	SY55XLMWSW1623	Call for application	Call for application
H.O. 50th							
FX Cruiser HO	09-16	1812	n/a	155mm	SY557525SW1319	SY557525SW1320	SY557525SW1321
FX Cruiser HO 1812	2008	1812	n/a	155mm	SY557525SW1319	SY557525SW1320	SY557525SW1321
FX Cruiser HO 1050	2008	1052	n/a	155mm	SY55XLMWSW1623	Call for application	Call for application
FX Cruiser HO	04-07	1052	16.8	155mm	SY55XLMWSW1623	Call for application	Call for application
FX Cruiser	03-08	998	17	155mm	SY55XLSW1319R	*SY55XLSW1319R or SY55XLSW1420R*	Call for application
V1 Sport	2016	1052	n/a	155mm	SY55XLMWSW1623	Call for application	Call for application
V1	2016	1052	n/a	155mm	SY55XLMWSW1623	Call for application	Call for application
GP 1200	97-99	1131	16.5/19, 15.2	155mm	*SY55XLSW1419 or SY55SSL1319**	*SY55XLSW1419 or SY55SSL1420**	SY55SSL14.521
GP 1300R	05-08	1296	n/a	155mm	SY55XLMWSW1319R or SY55XLMWSW1321R	SY55XLMWSW1319R or SY55XLMWSW1420R	SY55XLMWSW1420R
GP 1300R	03-04	1296	n/a	155mm	*SY55XLSW1319R or SY55XLSW1321R**	*SY55XLSW1319R or SY55XLSW1420R**	SY55XLSW1420R
GP 1200R	99-02	1131	16/19	155mm	SY55XLSW1319R	*SY55XLSW1319R or SY55XLSW1420R**	SY55XLSW1420R
GP 800	98-00	784	15/21, 17/1	144mm	SY44SS1420	SY44SS1422	SY44SS1422
GP 800R	01-05	784	13.2	155mm	SY55XLSW0714	Call for application	Call for application
GP 760	97-00	754	17/20	144mm	SY44SS1420	SY44SS1420	SY44SS1422
Raider 1100	95-96	1100	16/19	155mm	*SY55SW1419 or SY55SSL1420**	*SY55SW1419 or SY55SSL1420**	SY55SSL14.521
Raider 760	96	760	17/20	144mm	SY44SS1420	SY44SS1420	SY44SS1422
Raider 701	94-95	701	17/20	144mm	SY44SS14.518.5	SY44SS1519	SY44SS1420
	96-97	701	13/16 al	144mm	SY44SS1418	SY44SS14.518.5	SY44SS1420 to SY44SS1519
Raider DLX	95	701	17/20	144mm	SY44SS14.518.5	SY44SS1519	SY44SS1420

* Suggested for maximum bottom-to-mid range acceleration gains. ** Suggested for maximum top speed gains. Refer to the IJSBA Rulebook for a more detailed definition of "Stock, Limited, and Modified."

SKAT-TRAK IMPELLER DESIGNS AND PITCHES AVAILABLE

160-75-25-2 SWIRL

PITCH	PART NUMBER
13/20	SY607525-2SW1320
13/21	SY607525-2SW1321
13/22	SY607525-2SW1322
13/23	SY607525-2SW1323

155-75-25 SWIRL

PITCH	PART NUMBER
11/18	SY557525SW1118
11/19	SY557525SW1119
12/19	SY557525SW1219
13/19	SY557525SW1319
13/20	SY557525SW1320
13/21	SY557525SW1321

155-75-22 SWIRL

PITCH	PART NUMBER
13/19R	SY55XLMWSW1319R
13/21R	SY55XLMWSW1321R
16/23	SY55XLMWSW1623

155-75-20K YAM SWIRL

PITCH	PART NUMBER
15/23	SY55KYSW1523
16/23	SY55KYSW1623
16/24	SY55KYSW1624
17/24	SY55KYSW1724

155-61-22 SWIRL

PITCH	PART NUMBER
7/14	SY55XLSW0714
10/16	SY55XLSW1016
12/18R	SY55XLSW1218R
13/19R	SY55XLSW1319R
13/21R	SY55XLSW1321R
14/19	SY55XLSW1419
14/20R	SY55XLSW1420R

RECOMMENDED SKAT-TRAK IMPELLER

Model	Year	Engine	Orig. Imp.	Pump Dia.	Stock Engine	Limited Engine	Modified Engine
XLT 1200 Ltd.	99-05	1176	15.2, 15.6	155mm	SY55XLSW1218R	*SY55XLSW1218R or SY55XLSW1319R**	SY55XLSW1420R
XL 1200	98-99	1176	13/19	155mm	SY55SW1217	SY55SW1318	SY55SW1318
Venture 1100	96-97	1100	16/19	155mm	*SY55SW1419 or SY55SSL1319**	*SY55SW1419 or SY55SSL1420**	SY55SSL14.521
XLT 800	00-04	784	n/a	155mm	SY55XLSW1016	Call for application	Call for application
XL 760	98-00	754	11/14	155mm	SY55SW0714	Call for application	Call for application
XL 700	99-04	701	11/14	155mm	SY55SW0712	SY55SW0714	Call for application
Venture 760	97	760	11/14	155mm	SY55SW0714	SY55SW0714	Call for application
Venture 700	98	701	11/14	155mm	SY55SW0712	SY55SW0714	Call for application
Venture 700	95-96	701	17/20	144mm	SY44SS14.518.5	SY44SS1519	SY44SS1420
Blaster 2	96-97	760	13/16	155mm	SY55SW0714	SY55SW0714	Call for application
Blaster	93-96	701	15/18	144mm	SY44SS1418	SY44SS14.518.5	SY44SS1420 to SY44SS1519
Pro VXR	93-94	701	15/18	144mm	SY44SL1419	SY44SL1419	SY44SL1419 to SY44SL1520
VXR	91-95	650	14/19 al	144mm	SY44SL1318	SY44SL1419	SY44SL1419 to SY44SL1520
Wave 3 GP	94-95	701	15/18	144mm	*SY44SL1318 or SY44SL1419**	SY44SL1419	SY44SL1419 to SY44SL1520
Wave 3	97	701	13/16 al	144mm	SY44SL1318	SY44SL1318 to SY44SL1419	SY44SL1419 to SY44SL1520
Wave 3	91-96	650	13/16 al	144mm	SY44SL1318	SY44SL1318 to SY44SL1419	SY44SL1419 to SY44SL1520
SuperJet	94-16	701	13/16	144mm	SY4475SW1217	SY4475SW1318	SY4475SW1419 or SY4475SW1520
SuperJet	90-93	650	14/19 al	144mm	SY4475SW1217	SY4475SW1318	SY4475SW1419 or SY4475SW1520
SJ FreeStyle	all	all	n/a	144mm	SY4475SW1016	SY4475SW1217	SY4475SW1318 or SY4475SW1419
SJ Top Speed Smoothwater	all	all	n/a	144mm	SY44SS1418	SY44SS145185	SY44SS1519 or SY44SS1420
FX-1	94-95	701	21/27 al	n/a	SYFX1SL1924	SYFX1SL1924	SYFX1SL2025
LX 650	all	650	17 al	n/a	SYLX1619	SYLX1619	SYLX1720
Wave 500	all	500	16 al	n/a	SY500WR1316	SY500WR1316	SY500WR1417

* Suggested for maximum bottom-to-mid range acceleration gains. ** Suggested for maximum top speed gains. Refer to the IJSBA Rulebook for a more detailed definition of "Stock, Limited, and Modified."

SKAT-TRAK IMPELLER DESIGNS AND PITCHES AVAILABLE

155-61-20 SWIRL

PITCH	PART NUMBER
7/12	SY55SW0712
7/14	SY55SW0714
12/17	SY55SW1217
13/18	SY55SW1318
14/19	SY55SW1419
15/20	SY55SW1520
16/21	SY55SW1621

155-61-20 SSL

PITCH	PART NUMBER
14/18	SY55SSL1319
14.5/21	SY55SSL14.521
14/20	SY55SSL1420

144 SWIRL

PITCH	PART NUMBER
12/17	SY44SW1217
13/17	SY44SW1317
13/18	SY44SW1318
14/19	SY44SW1419
15/19	SY44SW1519
15/20	SY44SW1520
16/21	SY44SW1621

144 SSL

PITCH	PART NUMBER
14/18	SY44SS1418
14.5/18.5	SY44SS14.518.5
14/20	SY44SS1420
14/22	SSY44SS1422
15/19	SY44SS1519

144 SLIM LINE

PITCH	PART NUMBER
13/18	SY44SL1318
14/19	SY44SL1419
15/20	SY44SL1520
16/21	SY44SL1621

144-75 SWIRL

PITCH	PART NUMBER
10/16	SY4475SW1016
12/17	SY4475SW1217
13/18	SY4475SW1318
14/19	SY4475SW1419
15/20	SY4475SW1520



Skat-Trak
Performance Products

NEW



SKAT-TRAK MID SHAFT WRENCH

This new Skat-Trak tool will insert a Yamaha mid shaft and allow you to hold it while removing the coupler, without damaging the shaft.

Description
20mm Mid Shaft Wrench

Part No.
RWRVYAMMS

FOUR STROKE
INTAKE SYSTEMS
ENGINE/GASKETS
EXHAUST
DRIVE LINE HANDLING
ELECTRICAL
WATERLINE /BILGE
STEERING & CONTROLS
BODY
ACCESSORIES
SERVICE TOOLS /HARDWARE
CHEMICAL

RECOMMENDED SKAT-TRAK IMPELLER

Model	Year	Orig. Imp.	Pump Dia.	Stock Engine	Limited Engine	Modified Engine
Ultra 310 X	14-16	n/a	160mm	SK608320-2SW1621	SK608320-2SW1622	SK608320-2SW1623
Ultra 310 LX	14-16	n/a	160mm	SK608320-2SW1621	SK608320-2SW1622	SK608320-2SW1623
Ultra 310 R	14-16	n/a	160mm	SK608320-2SW1621	SK608320-2SW1622	SK608320-2SW1623
Ultra 310 X SE	15-16	n/a	160mm	SK608320-2SW1621	SK608320-2SW1622	SK608320-2SW1623
Ultra 300 X	11-13	n/a	160mm	SK608320SW1621	SK608320SW1622	SK608320SW1623
Ultra 300 LX	11-13	n/a	160mm	SK608320SW1621	SK608320SW1622	SK608320SW1623
Ultra 260 X	09-12	n/a	155mm	SK557520SW1419	Call for application	Call for application
Ultra 260 LX	09-10	n/a	155mm	SK557520SW1419	Call for application	Call for application
Ultra 250 X	07-08	n/a	155mm	SK557520SW1318	Call for application	Call for application
Ultra 250 LX	07-08	n/a	155mm	SK557520SW1016	Call for application	Call for application
Ultra 130 Di	01-04	n/a	Tapered	SK150SW1419	SK150SW1420	SK150SW1421/SK150SW1422/ SK150SW1423
Ultra 150	99-05	n/a	Tapered	SK150SW1419	SK150SW1420	SK150SW1421/SK150SW1422/ SK150SW1423
STX 12-F	04-08	n/a	148mm	*SK1100SW1319 or SK1100SW1319R**	SK1100SW1420	Call for application
STX 15-F	04-16	n/a	148mm	*SK1100SW1319 or SK1100SW1319R**	Call for application	Call for application
STX	09-12	n/a	148mm	*SK1100SW1319 or SK1100SW1319R**	Call for application	Call for application
1200 STX-R	02-05	n/a	148mm	*SK1100SW1424 or SK1100SW1424R**	*SK1100SW1424 or SK1100SW1424R**	*SK1100SW1424 or SK1100SW1424R**
1100 STX DI	00-03	n/a	148mm	SK1100SW1319R	SK1100SW1420	SK1100SW1422
1100 STX	97-99	8/22	148mm	SK1100SW1318	SK1100SW1318 to SK1100SW1319	SK1100SW1420 to SK1100SW1424
900 STX	01-06	12/17	148mm	SK1100SW1217	SK1100SW1318	SK1100SW1419
900 STX	97-00	10/24	140mm	*SK900SW1419 or SK900SL1520**	*SK900SW1419 or SK900SL1621**	*SK900SW1520 or SK900SL1722**
1100 ZXi	99-03	7/20	148mm	SK1100SW1318	*SK1100SW1318 or SK1100SW1319**	SK1100SW1420 to SK1100SW1424
900 ZXi	95-97	14/22	140mm	*SK900SW1419 or SK900SL1520**	*SK900SW1419 or SK900SL1621**	*SK900SW1520 or SK900SL1722**
900 STS	01-02	n/a	140mm	SK900SL1621	SK900SL1722	SK900SL1723
750 ZXi	95-97	14/22	140mm	SK900SW1318	SK900SW1318 to SK900SW1419	SK900SW1419 to SK900SW1520
750 Xi Sport	98-99	13/18	140mm	*SK900SW1217 or SK750ST1018**	*SK900SW1217 or SK750ST1119**	*SK900SW1318 or SK900SL1318**
750 Xi	96-97	13/18	140mm	*SK900SW1217 or SK750ST1018**	*SK900SW1217 or SK750ST1119**	*SK900SW1318 or SK900SL1318**
750 Xi	93-95	8/16 5-blade	140mm	SK750ST1018	SK750ST1119	*SK900SW1318 or SK900SL1318**
800 SX-R	03-12	n/a	140mm	SK4075SW1318	SK4075SW1419	SK4075SW1520

* Suggested for maximum bottom-to-mid range acceleration gains. ** Suggested for maximum top speed gains. Refer to the IJSBA Rulebook for a more detailed definition of "Stock, Limited, and Modified."

SKAT-TRAK IMPELLER DESIGNS AND PITCHES AVAILABLE

160-83-20-2 3-BLADE SWIRL

PITCH	PART NUMBER
16/21	SK608320-2SW1621
16/22	SK608320-2SW1622
16/23	SK608320-2SW1623

160-83-20 3-BLADE SWIRL

PITCH	PART NUMBER
16/21	SK608320SW1621
16/22	SK608320SW1622
16/23	SK608320SW1623

155-75-20 SWIRL

PITCH	PART NUMBER
12/19	SK557520SW1219
12/20	SK557520SW1220
13/18	SK557520SW1318
13/19	SK557520SW1319
13/21	SK557520SW1321
14/20	SK557520SW1420

ULTRA 150 SWIRL

PITCH	PART NUMBER
14/19	SK150SW1419
14/20	SK150SW1420
14/21	SK150SW1421
14/22	SK150SW1422
14/23	SK150SW1423
14/24	SK150SW1424

1100/1200 SWIRL

PITCH	PART NUMBER
12/17	SK1100SW1217
13/18	SK1100SW1318
13/19	SK1100SW1319
13/19R	SK1100SW1319R
14/19	SK1100SW1419
14/20	SK1100SW1420
14/23	SK1100SW1423
14/24	SK1100SW1424
14/24R	SK1100SW1424R
14/25	SK1100SW1425
14/25R	SK1100SW1425R
16/25	SK1100SW1625

750/900 SWIRL

PITCH	PART NUMBER
12/17	SK900SW1217
13/18	SK900SW1318
14/19	SK900SW1419
15/20	SK900SW1520
16/21	SK900SW1621
17/22	SK900SW1722

140-75 SWIRL

PITCH	PART NUMBER
9/17	SK4075SW0917
10/18	SK4075SW1018
13/18	SK4075SW1318
14/18	SK4075SW1418
14/19	SK4075SW1419
15/20	SK4075SW1520

750/900 SLIM LINE

PITCH	PART NUMBER
12/17	SK900SL1217
13/18	SK900SL1318
14/19	SK900SL1419
15/20	SK900SL1520
16/21	SK900SL1621
17/22	SK900SL1722
18/23	SK900SL1823



Skat-Trak
Performance Products

RECOMMENDED SKAT-TRAK IMPELLER

Model	Year	Orig. Imp.	Pump Dia.	Stock Engine	Limited Engine	Modified Engine
750 Sxi Pro	98-02	9/17	140mm	*SK750ST0917 or SK750ST1018**	*SK900SW1217 or SK750ST1018**	*SK900SW1318 or SK900SL1318**
750 SXi	95-96	9/17	140mm	*SK750ST0917 or SK750ST1018**	*SK900SW1217 or SK750ST1018**	*SK900SW1318 or SK900SL1318**
750 SX	92-95	14/19 alum.	140mm	SK750ST0917	SK750ST0917 to SK750ST1018	*SK900SW1318 or SK900SL1318**
750 SS	96-97	12/17	140mm	SK750ST0917	SK750ST0917 to SK750ST1018	*SK900SW1318 or SK900SL1318**
	92-95	14/19 alum.	140mm	SK750ST0917	SK750ST0917 to SK750ST1018	*SK900SW1318 or SK900SL1318**
750 XIR	94	9/17	140mm	SK750ST0917	SK750ST0917 to SK750ST1018	*SK900SW1318 or SK900SL1318**
750 STX	98	12/17	140mm	*SK900SW1217 or SK750ST1018**	SK900SW1318	SK900SW1419
750 STS	96-97	12/17	140mm	*SK900SW1217 or SK750ST1018**	*SK900SW1217 or SK750ST1119**	*SK900SW1318 or SK900SL1318**
	95	13/18	140mm	*SK900SW1217 or SK750ST1018**	*SK900SW1217 or SK750ST1119**	*SK900SW1318 or SK900SL1318**
750 ST	95	13/21	140mm	SK750ST0917	SK750ST0917 to SK750ST1018	*SK900SW1318 or SK900SL1318**
	93-94	10/18 alum. 5-bl.	140mm	SK750ST0917	SK750ST0917 to SK750ST1018	*SK900SW1318 or SK900SL1318**
650 TS	89-96	16.5 alum.	140mm	SK650ST0917	SK650ST0917 to SK650ST1018	SK650ST1119
650 SX	86-93	15 alum.	140mm	SK650ST0816	SK650ST0917	SK650ST1018 to SK650ST1119
650 X-2	86-95	18 alum.	140mm	SK650ST0816	SK650ST0917	SK650ST1018 to SK650ST1119
650 SC	91-95	16.5 alum.	140mm	SK650ST0917	SK650ST0917 to SK650ST1018	SK650ST1119
650 JM	91-92	15 alum.	140mm	SK650ST0917	SK650ST0917 to SK650ST1018	SK650ST1119
550 SX	90-95	17.5 alum.	Tapered	SK550SX1316	SK550SX1316	SK550SX1417
550 JS	82-89	16 alum.	Tapered	SK550ST1316	SK550ST1316	SK550ST1417
440 JS	77-94	15 alum.	121.7mm	SK440ST1316	SK440ST1316	SK440ST1417
300 SX	87-91	15 alum.	121.7mm	SK440ST1316	SK440ST1316	SK440ST1417
300 JS	86-88	15 alum.	121.7mm	SK440ST1316	SK440ST1316	SK440ST1417

* Suggested for maximum bottom-to-mid range acceleration gains. ** Suggested for maximum top speed gains. Refer to the IJSBA Rulebook for a more detailed definition of "Stock, Limited, and Modified."

SKAT-TRAK IMPELLER DESIGNS AND PITCHES AVAILABLE

750 STANDARD

PITCH	PART NUMBER
8/16	SK750ST0816
9/17	SK750ST0917
10/18	SK750ST1018
11/19	SK750ST1119
12/20	SK750ST1220

650 STANDARD

PITCH	PART NUMBER
8/16	SK650ST0816
9/17	SK650ST0917
10/18	SK650ST1018
11/19	SK650ST1119

550 JS

PITCH	PART NUMBER
13/16	SK550ST1316
14/17	SK550ST1417

550 SX

PITCH	PART NUMBER
13/16	SK550SX1316
14/17	SK550SX1417

SKAT-TRAK REPLACEMENT NOSE BOOT AND O-RING



Description	Part No.
1. SJ/FX	RIMPNOSEBOOT6
2. KAW/SD/YAM/SWIRL	RIMPNOSEBOOT7
3. YAM GPR.XL-L	RIMPNOSEBOOTYAMXL
4. SD SUPER SLIM LINE	RIMPNOSEBOOTSDDL
5. O-RING KAWASAKI	RIMPKAWORDING
6. 750/900 PLUG O-RING	RIMP750PLUG
7. O-RING Sea-Doo	RIMPSORING

SKAT-TRAK KAWASAKI SX-R TILT/TRIM NOZZLE SYSTEM

Skat-Trak Tilt (up) /Trim (down)* system fits Skat-Trak 140mm to 145mm, OEM Kawasaki 140mm SX-r and Solas 140mm pumps. The exit nozzle features interchangeable rings** to allow for precise pump tuning. The kit includes: Exit nozzle (no syphon), steering nozzle, trim tube, trim cable, trim tube seals (2) and "Pulley" tilt/trim assembly. No lever included. See page 257 for lever.



Exit Nozzle	Exit Ring	Steering Size	Part No.
140-145mm	83mm, 84mm	87mm (Fixed)	PRNKAW800SXR-E83/84S87
Trim Cable			PRSTKAWSXRT

*This system will only go one direction (up or down) based on installation
**2 rings are included, additional rings sold separately.



SKAT-TRAK 5/8" TRIM TUBE SEAL/NIPPLE

This Skat-Trak seal seals the trim cable to the trim tube to prevent any water from entering the engine compartment via the trim tube. Hot Products recommends you use a seal on both ends of the tube. Sold individually.

Description	Part No.
5/8" Trim Tube Seal	SK TRIM SEAL

FOUR STROKE
INTAKE SYSTEMS
ENGINE/GASKETS
EXHAUST
DRIVE LINE HANDLING
ELECTRICAL
WATERLINE /BILGE
STEERING & CONTROLS
BODY
ACCESSORIES
SERVICE TOOLS /HARDWARE
CHEMICAL

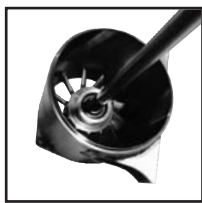

Skat-Trak
Performance Products



SKAT-TRAK YAMAHA 148MM FREERIDE AND 155MM FREESTYLE PUMP

Skat-Trak Yamaha Pump designed specifically for maximum performance applications. Fits all OEM Yamaha based hulls; RICKTER, Hurricane, KDX, Tigercraft, Superfreak...

Description	Part No.
148 Pump (D-75) Specifications: 148mm Billet One piece, 75mm hub, 12 Vein, Setback, Skat-Trak medium tail cone, Skat-Trak impeller and RICKTER extended drive shaft. Trim system not included	PSYMAG148/75-12VSB
155 Pump (E-75) Specifications: 155mm Billet One piece, 75mm hub, 14 Vein, Setback, Skat-Trak medium tail cone, Skat-Trak impeller and RICKTER extended drive shaft. Trim system not included	PSYMAG155/75-14VSB

SKAT-TRAK KAWASAKI SX-R 145MM MAGNUM RACE PUMP

Skat-Trak Kawasaki SX-r Pump designed specifically for race applications and maximum performance. Fits all OEM Kawasaki SX-r, Bullett Racing, Kommander K1, Trinity and WWR hulls.

Description	Part No.
Pump (C+83) Specifications: 145mm, 83mm hub, 14 Vein, Setback, Skat-Trak tail cone, Skat-Trak impeller and extended drive shaft. Trim system not included	PSKMAG145/83-14VSB

SKAT-TRAK MAGNUM PUMP REPLACEMENT BEARINGS AND SEALS



REPLSDKAWSB2-75



REPLSDKAWSB2-83

REPLACEMENT BEARINGS & SEALS FOR SEA-DOO AND KAWASAKI (STAND-UP) MAGNUM PUMP

Description	Part No.
Sea-Doo/Kawasaki Standard	REPLSDKAWSB2-75
Sea-Doo/Kawasaki Set-Back Metal	REPLSDKAWSB2-83
Sea-Doo/Kawasaki Seal (sold individually)	REPLSDKAWMS



REPLSDKAWMS



Skat-Trak
Performance Products



REPLYAMSTD

REPLACEMENT BEARINGS & SEALS FOR YAMAHA STAND-UP MAGNUM PUMP

Description	Part No.
Super Jet Standard Kit (2 Bearings & 2 Seals)	REPLYAMSTD
Super Jet Set Back Kit (2 Bearings & 2 Seals)	REPLYAMSB

SKAT-TRAK MAGNUM YAMAHA TILT/TRIM SYSTEM

See Page 181 for Kawasaki Tilt/Trim System.

See Page 183 for Replacement Rings



SKAT-TRAK YAMAHA TILT (UP) NOZZLE SYSTEM

Skat-Trak Tilt (up) system exit nozzle features interchangeable rings* to allow for precise pump tuning. Kit includes: Exit nozzle (no syphon), steering nozzle, trim tube, trim cable, trim tube seals (2) and "Pulley" tilt/trim assembly. No lever included. See page 257 for lever.

144/160mm tilt nozzles are also available, call for details.

Exit Nozzle	Exit Ring	Steering Ring	Part No.
148mm 6 vein (Choice of 2 sizes)	82/84mm	Short-88mm	PRNYAMSJ148TL-E82/84-S88
155mm 6 vein	88/90mm	Short-92mm	PRNYAMSJ155TL-E88/90-S92

*2 rings are included, additional rings sold separately.



SKAT-TRAK YAMAHA 144 TRIM (DOWN) RACE NOZZLE SYSTEM

Skat-Trak Tilt (Down) system exit nozzle features interchangeable rings* to allow for precise pump tuning. Kit includes: Exit nozzle (no syphon), steering nozzle, trim tube, trim cable, trim tube seals (2) and "Pulley" tilt/trim assembly. No lever included. See page 257 for lever.

144 Trim fits 144mm pump. 148/155/160mm nozzle kits are also available, call for details.

Exit Nozzle	Exit Ring	Steering Ring	Part No.
144mm 6 vein	83/84mm	Long-88mm	PRNYAMSJTR-E83/84-S88

*2 rings are included, additional rings sold separately.

SKAT-TRAK MAGNUM PUMP TAIL CONES

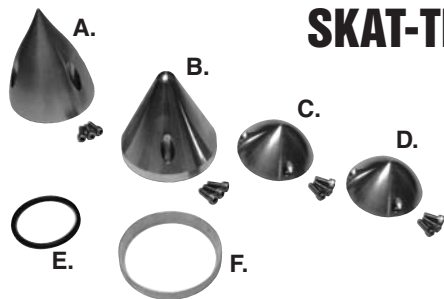

KAWASAKI/SEA-DOO/ HYDROSPACE MAGNUM 75MM HUB

Description	Part No.
A. 75mm Hub Tail Cone 3.75" with Aluminum Spacer - Large	PRTCK/S375
B. 75mm Hub Tail Cone 3" with Aluminum Spacer - Medium	PRTCK/S3
C. 75mm Hub Tail Cone West Coast Special	PRTCK/SWC
D. 75mm Hub Tail Cone 1.75" with Aluminum Spacer - Small	PRTCK/S175
E. 75mm Hub Tail Cone O-Ring	PRTCK/SOR
F. 75mm Hub Tail Cone Aluminum Spacer	PRTCK/SAS

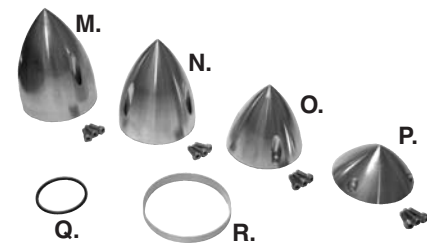

YAMAHA MAGNUM 75MM HUB

Description	Part No.
M. 75mm Hub Tail Cone 4"	PRTCYAM4
N. 75mm Hub Tail Cone 3.5" - Large	PRTCYAM35
O. 75mm Hub Tail Cone 2.75" - Medium	PRTCYAM275
P. 75mm Hub Tail Cone 1.75" - Small	PRTCYAM175
Q. 75mm Hub Tail Cone O-Ring	PRTCYAMOR
R. 75mm Hub Tail Cone 3.5" and 4" Aluminum Spacer	PRTCYAMAS

YAMAHA-GPR/KAWASAKI/SEA-DOO MAGNUM EXIT NOZZLE RING (BLACK)

Size	Part No.
80	PRNYRING-80
81	PRNYRING-81
82	PRNYRING-82
83	PRNYRING-83
84	PRNYRING-84
85	PRNYRING-85
86	PRNYRING-86
87	PRNYRING-87

Size	Part No.
88	PRNYRING-88
89	PRNYRING-89
90	PRNYRING-90
91	PRNYRING-91
92	PRNYRING-92
93	PRNYRING-93
94	PRNYRING-94
95	PRNYRING-95

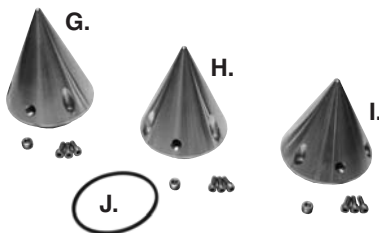

KAWASAKI/ HYDROSPACE MAGNUM 83MM HUB

Description	Part No.
G. 83mm Hub Tail Cone 4" - Large	PRTCK83400
H. 83mm Hub Tail Cone 3.75" - Medium	PRTCK833.75
I. 83mm Hub Tail Cone 3.35" - Small	PRTCK833.35
J. 83mm Hub Tail Cone O-Ring	PRTCK83OR

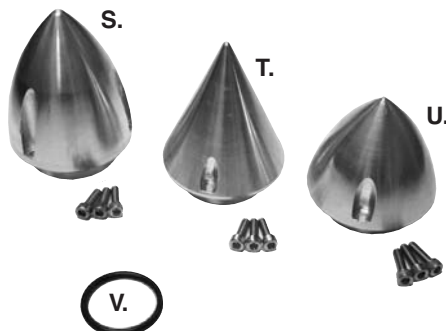

YAMAHA MAGNUM 83MM HUB

Description	Part No.
S. 83mm Hub Tail Cone 4" - Large	PRTCY83400
T. 83mm Hub Tail Cone 3.75" - Medium	PRTCY833.75
U. 83mm Hub Tail Cone 3.35" - Small	PRTCY833.35
V. 83mm Hub Tail Cone O-Ring	PRTCY83OR

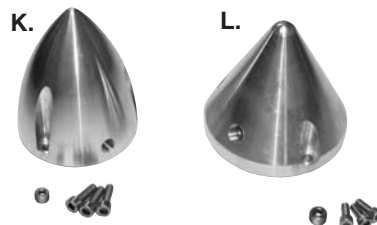

SEA-DOO MAGNUM 83MM HUB

Description	Part No.
K. 83mm Hub Tail Cone - 4.32"	PRTCSD833
L. 83mm Hub Tail Cone - 3"	PRTCSD834.32

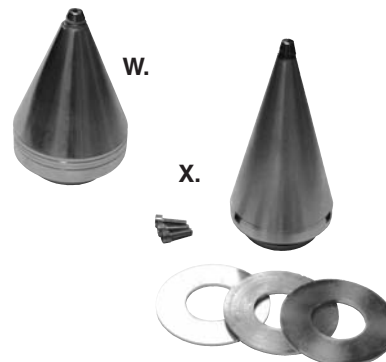

MAGNUM PUMP ADJUSTABLE TAIL CONE

Description	Part No.
W. Kaw/HS 83mm Hub Tail Cone Adjustable	PRTCK83ADJ
X. Yamaha 83mm Hub Tail Cone Adjustable	PRTCY83ADJ



YAMAHA 144MM-160MM TILT/TRIM NOZZLE RINGS STAINLESS STEEL SILVER

Size	Part No.
80	PRNYAMRING-80
81	PRNYAMRING-81
82	PRNYAMRING-82
83	PRNYAMRING-83
84	PRNYAMRING-84
85	PRNYAMRING-85
86	PRNYAMRING-86

Size	Part No.
87	PRNYAMRING-87
88	PRNYAMRING-88
89	PRNYAMRING-89
90	PRNYAMRING-90
91	PRNYAMRING-91
92	PRNYAMRING-92

FOUR STROKE
INTAKE SYSTEMS
ENGINE/GASKETS
EXHAUST
DRIVE LINE HANDLING
ELECTRICAL
WATERLINE /BILGE
STEERING & CONTROLS
BODY
ACCESSORIES
SERVICE TOOLS /HARDWARE
CHEMICAL

1988-2016 SEA-DOO WATERCRAFT



SEA-DOO

Engine cc	Model	Year	PUMP Diameter	RECOMMENDED SOLAS IMPELLER			
				SERIES	STOCK Engine	LIMITED Engine	MODIFIED Engine
1494	RXP-X 260	2012-	159mm	CONCORD	SRZ-CD-15/21A	SRZ-CD-15/21A	SRZ-CD-16/21A
	RXT IS 260 / RXT-X 260 / RXT 260 / RXT-X a5260	2009-		CONCORD	SRZ-CD-15/21A	SRZ-CD-15/21A	SRZ-CD-16/21A
	GTX LTD IS 255 / GTX LTD IS 260	2009-		CONCORD	SRZ-CD-15/21A	SRZ-CD-15/21A	SRZ-CD-16/21A
	RXP-X 255	2009-		CONCORD	SRZ-CD-15/21A	SRZ-CD-15/21A	SRZ-CD-16/21A
	RXP(215HP)	2009-2010		CONCORD	SRZ-CD-14/19A	SRZ-CD-14/19A	SRZ-CD-15/20A.16/21A
	RXT(215HP)	2009-2010		CONCORD	SRZ-CD-13/18A	SRZ-CD-14/19A	SRZ-CD-15/20A.16/21A
	WAKE PRO(215hp)	2009-		CONCORD	SRZ-CD-13/18A	SRZ-CD-14/19A	SRZ-CD-15/20A.16/21A
	GTX 215 / GTX IS 215 / GTX LTD 215	2009-		CONCORD	SRZ-CD-13/18A	SRZ-CD-14/19A	SRZ-CD-15/20A.16/21A
	GTR(215HP)	2012-		CONCORD	SRZ-CD-14/19A	SRZ-CD-14/19A	SRZ-CD-15/20A
	RXP-X	2008		CONCORD	SRX-CD-15/21	SRX-CD-15/21	
	RXT-X	2008	CONCORD	SRX-CD-14/19	SRX-CD-14/19		
	RXP(215HP)	2004-	CONCORD	SRX-CD-14/19	SRX-CD-14/19	SRX-CD-15/20	
	RXT(215HP)	2005-	CONCORD	SRX-CD-13/18	SRX-CD-14/19	SRX-CD-15/20	
	GTX Limited(215HP)	2005-	CONCORD	SRX-CD-13/18	SRX-CD-14/19	SRX-CD-15/20	
	WAKE SUPERCHARGED(215HP)	2007-	CONCORD	SRX-CD-13/18	SRX-CD-14/19	SRX-CD-15/20	
	GTX 4-tech Limited Supercharge(185HP)	2003-2004	CONCORD	SR-CD-12/20	SR-CD-13/21	SR-CD-13/21	
	GTX 4-tech Supercharge(185HP)	2003-2006	CONCORD	SR-CD-12/20	SR-CD-12/20	SR-CD-13/21	
	RXP(155HP)	2007-	CONCORD	SR-CD-11/19	SR-CD-12/20	SR-CD-12/20	
	GTS 130 / GTS PRO 130	2011-	CONCORD	SR-CD-11/19	SR-CD-12/20	SR-CD-12/20	
	wake(155HP)	2008-	CONCORD	SR-CD-11/19	SR-CD-12/20	SR-CD-12/20	
	GTX 155	2002-2009	155.5mm	CONCORD	SR-CD-11/19	SR-CD-12/20	SR-CD-12/20
GTX 155 / GTX S 155	2010-	CONCORD	SRB-CD-11/19	SRB-CD-11/19	SRB-CD-11/19		
GTI LTD 155 / GTI SE 155	2008-	CONCORD	SR-CD-10/18	SR-CD-11/19	SR-CD-11/19		
GTI / GTI SE 130 / GTI SE / GTI STD / GTI 4-TEC SE / GTI 4-TEC STD / GTI 4-TEC RENTAL / GTI 130 / GTI Rental 130	2006-	CONCORD	SR-CD-10/18	SR-CD-11/19	SR-CD-11/19		
951	RXX	2001-2002	148mm	CONCORD	KG-CD-15/21	KG-CD-16/22	KG-CD-16/22
	XP / XP DI	2000-2004	155.5mm	CONCORD	ST-CD-15/20	ST-CD-16/21	ST-CD-17/22
				DYNAFLY	ST-DF-13/19	ST-DF-13/19	ST-DF-14/20
	RX / RX DI	2000-2003		CONCORD	ST-CD-15/20	ST-CD-16/21	ST-CD-17/22
				DYNAFLY	ST-DF-13/19	ST-DF-13/19	ST-DF-14/20
	GTX/GTX DI	2000-2003		CONCORD	ST-CD-15/20	ST-CD-15/20	ST-CD-16/21
				DYNAFLY	ST-DF-13/19	ST-DF-13/19	ST-DF-14/20
	GSX Ltd. / GTX Ltd. / XP Ltd.	98-99		CONCORD	ST-CD-15/20	ST-CD-15/20	ST-CD-16/21
		X Prop		ST-SC-X(14.5-17.5)	ST-SC-X(14.5-17.5)	ST-SC-X(15.5-18.5)	
LRV / LRV DI	99-2003	CONCORD	ST-CD-14/19	ST-CD-14/19	ST-CD-15/20		
		X Prop	ST-SC-X(14.5-17.5)	ST-SC-X(14.5-17.5)	ST-SC-X(15.5-18.5)		
900	SPARK ACE 900 / SPARK ACE 900 HO	2014-	140mm	CONCORD	SK-CD-12/17	SK-CD-12/17	SK-CD-13/18
	3D / 3D BASE	2005-2007	155.5mm	CONCORD	ST-CD-10/16	ST-CD-10/16	
	GSX RFI / GTX RFI	99-2000	140mm	CONCORD	SF-CD-15/23	SF-CD-16/24	SF-CD-17/25
782	XP / SPX / GSX	96-98	140mm	CONCORD	SD-CD-15/23	SD-CD-16/24	SD-CD-17/25
				X Prop	SD-SC-X(16.5-23.5)	SD-SC-X(16.5-23.5)	SD-SC-X(17-24)
	GTX / GTX PRO	96-98		CONCORD	SD-CD-14/22	SD-CD-15/23	SD-CD-16/24
		X Prop	SD-SC-X(16.5-23.5)	SD-SC-X(16.5-23.5)	SD-SC-X(17-24)		
720	GTI / GTI LE / GTI RFI	2001-2005	155.5mm	CONCORD	ST-CD-10/16	ST-CD-10/16	
	GTS	2001-2002		CONCORD	ST-CD-10/16	ST-CD-10/16	
			CONCORD	SD-CD-14/22	SD-CD-15/23	SD-CD-16/24	
	XP / SPX	95-97	140mm	X Prop	SD-SC-X(16-23)	SD-SC-X(16-23)	SD-SC-X(16.5-23.5)
				IJK SERIES	SD-SC-I(14-19)	SD-SC-J(15-20)	SD-SC-K(16-21)
				CONCORD	SD-CD-14/22	SD-CD-15/23	SD-CD-16/24
				X Prop	SD-SC-X(16-23)	SD-SC-X(16-23)	SD-SC-X(16.5-23.5)
	GS / GSI	97-2001		IJK SERIES	SD-SC-I(14-19)	SD-SC-J(15-20)	SD-SC-K(16-21)
				CONCORD	SD-CD-14/22	SD-CD-15/23	SD-CD-16/24
				X Prop	SD-SC-X(16-23)	SD-SC-X(16-23)	SD-SC-X(16.5-23.5)
				IJK SERIES	SD-SC-I(14-19)	SD-SC-J(15-20)	SD-SC-K(16-21)
	GTI / GTS	96-2000	X Prop	SD-SC-X(16-23)	SD-SC-X(16-23)	SD-SC-X(16.5-23.5)	
		IJK SERIES	SD-SC-I(14-19)	SD-SC-J(15-20)	SD-SC-K(16-21)		
HX	95-	X Prop	SD-SC-X(16-23)	SD-SC-X(16-23)	SD-SC-X(16.5-23.5)		
		IJK SERIES	SD-SC-I(14-19)	SD-SC-J(15-20)	SD-SC-K(16-21)		

SRX CONCORD

PITCH	PART NUMBER
13/18	SRX-CD-13/18
14/19	SRX-CD-14/19
15/21	SRX-CD-15/21

SR CONCORD

PITCH	PART NUMBER
10/18	SR-CD-10/18
11/19	SR-CD-11/19
12/20	SR-CD-12/20
13/21	SR-CD-13/21

SRZ CONCORD

PITCH	PART NUMBER
13/18A	SRZ-CD-13/18A
14/19A	SRZ-CD-14/19A
15/21A	SRZ-CD-15/21A

ST CONCORD

PITCH	PART NUMBER
14/19	ST-CD-14/19
15/20	ST-CD-15/20
16/21	ST-CD-16/21
17/22	ST-CD-17/22

SK CONCORD

PITCH	PART NUMBER
12/17	SK-CD-12/17
13/18	SK-CD-13/18

ST DYNAFLY

PITCH	PART NUMBER
12/18	ST-DF-12/18
13/19	ST-DF-13/19
14/20	ST-DF-14/20

SD CONCORD

PITCH	PART NUMBER
14/22	SD-CD-14/22
15/23	SD-CD-15/23
16/24	SD-CD-16/24



1988-2016 SEA-DOO WATERCRAFT (CONT'D) & MERCURY

MERCURY CONCORD

PITCH	PART NUMBER
18/27	MC-CD-18/27
22/39	MC-CD-22/39

UK SERIES

PITCH	PART NUMBER
14/19	SD-SC-I(14-19)
15/20	SD-SC-J(15-20)

ABC SERIES

PITCH	PART NUMBER
13/18	SD-SC-A (13-18)
14/19	SD-SC-B (14-19)
15/20	SD-SC-C (15-20)



Engine cc	Model	Year	PUMP Diameter	RECOMMENDED SOLAS IMPELLER			
				SERIES	STOCK Engine	LIMITED Engine	MODIFIED Engine
650	XP	93-94	140mm	UK SERIES	SD-SC-I(14-19)	SD-SC-I(14-19)	SD-SC-J(15-20)
	SPX	94-95		UK SERIES	SD-SC-I(14-19)	SD-SC-I(14-19)	SD-SC-J(15-20)
	GSX	94-95		UK SERIES	SD-SC-I(14-19)	SD-SC-I(14-19)	SD-SC-J(15-20)
	GTX	94-95		UK SERIES	SD-SC-I(14-19)	SD-SC-I(14-19)	SD-SC-J(15-20)
580	XP	91-92	140mm	ABC SERIES	SD-SC-A(13-18)	SD-SC-B(14-19)	SD-SC-C(15-20)
	SPX	93		ABC SERIES	SD-SC-A(13-18)	SD-SC-B(14-19)	SD-SC-C(15-20)
	SPI	93-96		ABC SERIES	SD-SC-A(13-18)	SD-SC-B(14-19)	SD-SC-C(15-20)
	SP	88-96		ABC SERIES	SD-SC-A(13-18)	SD-SC-B(14-19)	SD-SC-C(15-20)
	GSX	92-93		ABC SERIES	SD-SC-A(13-18)	SD-SC-B(14-19)	SD-SC-C(15-20)
	GTX	92-93		ABC SERIES	SD-SC-A(13-18)	SD-SC-B(14-19)	SD-SC-C(15-20)
	GTS	92-96		ABC SERIES	SD-SC-A(13-18)	SD-SC-B(14-19)	SD-SC-C(15-20)
	GT	90-91		ABC SERIES	SD-SC-A(13-18)	SD-SC-B(14-19)	SD-SC-C(15-20)

SEA-DOO JETBOAT

Engine cc	Model	Horse Power	Year	PUMP Diameter	RECOMMENDED SOLAS IMPELLER	
					SERIES	STOCK Engine
4-TEC / 1494cc	205 Utopia / Utopia SE	2 X 215HP	2007~	159mm	CONCORD	SRX-CD-14/19
	180 Challenger / Challenger SE	215 HP	2007~	159mm	CONCORD	SRX-CD-14/19
	230 Challenger / Challenger SE	2 X 215HP	2007~	159mm	CONCORD	SRX-CD-14/19
		2 X 155HP		155.5mm	CONCORD	SR-CD-11/19
	230 Wake	2 X 215HP	2007~	159mm	CONCORD	SRX-CD-14/19
		2 X 155HP		155.5mm	CONCORD	SR-CD-11/19
	Islandia SE	2 X 155HP	2007~	155.5mm	CONCORD	SR-CD-11/19
	SPEEDSTER 150	155HP	2007~	155.5mm	CONCORD	SR-CD-11/19
		215 HP	2007~	159mm	CONCORD	SRX-CD-14/19
	SPEEDSTER 200	2 X 215HP	2007~	159mm	CONCORD	SRX-CD-14/19
		2 X 155HP	2004~	155.5mm	CONCORD	SR-CD-11/19
	SPEEDSTER WAKE	2 X 215HP	2006~	159mm	CONCORD	SRX-CD-14/19
	SPORTSTER 4-TEC	155HP	2004-2005	155.5mm	CONCORD	SR-CD-11/19
951	Sportster LE DI		2000-2005	155.5mm	CONCORD	ST-CD-15/20
780(2)	Speedster		98-99	140mm	CONCORD	SF-CD-15/23
	Challenger 1800		97-99		CONCORD	SD-CD-15/23
780	Challenger		95-97	140mm	X Prop	SD-SC-X(16.5-23.5)
	Speedster SK		99		X Prop	SD-SC-X(16-23)
720(2)	Speedster 1800		99	140mm	X Prop	SD-SC-X(16-23)
	Sportster LT		2002		X Prop	SD-SC-X(16-23)
720	Challenger		98-2001	140mm	X Prop	SD-SC-X(16-23)
	Speedster		96-97		X Prop	SD-SC-X(16-23)
	Explorer		97		X Prop	SD-SC-X(16-23)
650(2)	Sportster		95-98	140mm	X Prop	SD-SC-X(16-23)
	Speedster		94-95		ABC SERIES	SD-SC-A(13-18,R) SD-SC-B(14-19,L)
650	Sportster		95	140mm	ABC SERIES	SD-SC-A(13-18)
	Explorer		95-96		ABC SERIES	SD-SC-A(13-18)
	Explorer		93-95		ABC SERIES	SD-SC-A(13-18)

MERCURY SPORT JET IMPELLERS

Engine cc	Model	Year	PUMP Diameter	RECOMMENDED SOLAS IMPELLER	
				SERIES	STOCK Engine
90 HP	90 Jet (Spline)	1993-1995	184mm	CONCORD	MB-SCA
175 HP	175 XR2 Jet	1997-2000		CONCORD	MC-CD-18/27
	Speedster	2000-2002		CONCORD	MC-CD-22/39
	Speedster SK	2000		CONCORD	MC-CD-22/39
Mercury V6	Speedster 160	2004		CONCORD	MC-CD-22/39
250HP	Challenger 1800	2000-2005		CONCORD	MC-CD-22/39
240HP	Challenger 2000	2000-2005		CONCORD	MC-CD-22/39
210HP	Challenger X	2004-2005		CONCORD	MC-CD-22/39
200HP	Sportster 1800	2000		CONCORD	MC-CD-22/39
(M2 Jet)	Utopia 205	2002-2005		CONCORD	MC-CD-22/39
	Utopia 185	2001-2005		CONCORD	MC-CD-22/39
	Islandia	2001-2005		CONCORD	MC-CD-22/39

MC-CD-22/39
for
Mercury Sportjet



"This is a highly efficient 4-blade, Stainless Steel, progressive pitch impeller delivering excellent thrust and superior overall performance for the Mercury SportJet model jet drive."

Mercury SportJet is a registered trademark of Mercury Marine, Inc.



FOUR STROKE
INTAKE SYSTEMS
ENGINE/GASKETS
EXHAUST
DRIVE LINE HANDLING
ELECTRICAL
WATERLINE /BILGE
STEERING & CONTROLS
BODY
ACCESSORIES
SERVICE TOOLS /HARDWARE
CHEMICAL

YAMAHA JETBOAT



2015 FREEGUN JETCROSS WORLD CUP IN DONCASTER, U.K.
PHOTO COURTESY OF KYLE ARAIZA.

Engine cc	Model	Year	PUMP Diameter	RECOMMENDED SOLAS IMPELLER	
				SERIES	STOCK ENGINE
1200	Exciter 135	98-2000	155mm	UK SERIES	YD-SC-I(13-19)
1100(2)	Exciter 220	97-98	155mm	UK SERIES	YD-SC-I(13-19)
1200(2)	Exciter 270	98-2000	155mm	X Props	YD-SC-X(13-16)
1200(2)	LS2000 / LX2000	1999-2002		UK SERIES	YD-SC-I(13-19)
1200(2)	LX210	2003-2005		CONCORD	YD-CD-12/18
1200(2)	AR210	2004-2005		X Props	YD-SC-X(13-16)
1200(2)	XR1800	2000-2001		CONCORD	YD-CD-12/18
998(2)	SX 230 / SR 230 / AR 230	2004-2005		X Props	YF-SC-X(13-16)
1052(2)	SX210 / AR210 / SR210	2006~		DYNAFLY	YG-DF-14/20
	SX230 / AR230 / SR 230	2006		CONCORD	YF-CD-13/19
	SX230 HO / AR230 HO / SR 230 HO	2005~		DYNAFLY	YG-DF-14/20

SOLAS IMPELLER ACCESSORIES

SEA-DOO

Impeller Series	Wrench	Seal
SD (A.B.C)	WR001	SL007
SD (UK)	WR001	SL007
SD, ST (Xprop)	WR001	SL007
SD,SF,ST(Concord)	WR001	SL007
ST (Dynaflly)	WR001	SL007
SK (Concord)	WR001	SL009
SR (Concord)	WR011	SLA011 (24mm shaft) SLA011A (27mm shaft)
SRZ,SRX (Concord)	WR012	SLA012

YAMAHA

Impeller Series	Wrench	Holder	Seal
YA (ABC)	WR003	WR003H	SL003
YB (UK, Xprop, Concord)	WR004	WR004H	SLA008 (18mm shaft) SL008A (15mm shaft)
YD (UK, Xprop)	WR004	WR004H	SLA008 (18mm shaft)
YD (Concord)	WR007	WR004H	SLA009A
YF (Concord, Xprop)	WR007	WR007H	SLA009
YG (Dynaflly)	WR007	WR007H	SLA009
YQ (Concord)	WR007	WR007H	SL007 / SL009
YS (Dynaflly)	WR014	WR014H	SLA014
YV (Concord)	WR014	WR014H	SLA014
YS (Concord)	WR014	WR014H	SLA016
YS-TP (Concord)	WR015	WR014H	SLA016
YH (Concord)	WR001		SLA009

KAWASAKI

Impeller Series	Wrench	Seal
KA (ABC, UK)	WR001	SLA009
KB (ABC)	WR002	SL002
KC (ABC)	WR005	Original OEM
KD (ABC)	WR001	SLA009
KE (ABC, UK, Xprop, concord)	WR001	SLA009
KP (Concord, Dynaflly)	WR001	SLA009
KF (UK, Xprop)	WR001	SLA009
KG (Xprop, Concord)	WR001	SLA009
KX (Concord)	WR001	SLA009
KH (Dynaflly)	WR001	SL007
KR (Concord)	WR001	SL009/SLA009



WR011



SLA011



WR004



WR003H



SL003



SLA016



SL002



WR012



SLA011A



WR007



WR004H



SL008A



WR001



SL007



SLA012



WR014



WR007H



SLA008



WR002



SL009



WR015



WR014H



SLA014



WR005



SLA009

SOLAS
Where speed begins

FOUR
STROKE
INTAKE
SYSTEMS
ENGINE/
GASKETS
EXHAUST
DRIVE LINE
HANDLING
ELECTRICAL
WATERLINE
/BLIGE
& CONTROLS
STEERING
BODY
ACCESSORIES
SERVICE TOOLS
/HARDWARE
CHEMICAL

1977-2016 KAWASAKI WATERCRAFT

KG CONCORD

PITCH	PART NUMBER
12/18	KG-CD-1218
13/19	KG-CD-1319
14/20	KG-CD-1420
14/21	KG-CD-1421
15/21	KG-CD-1521
16/22	KG-CD-1622

KE CONCORD

PITCH	PART NUMBER
09/15	KE-CD-0915
11/16	KE-CD-1116
12/18	KE-CD-1218
13/19	KE-CD-1320

KP DYNAFLY

PITCH	PART NUMBER
13/22	KP-DF-1322
14/23	KP-DF-1423
15/24	KP-DF-1524

KR CONCORD

PITCH	PART NUMBER
14/21	KR-CO-1421
15/22	KR-CO-1522

KH DYNAFLY

PITCH	PART NUMBER
16/20	KH-DF-1620
17/21	KH-DF-1721

KX CONCORD

PITCH	PART NUMBER
10/16	KX-CD-1016
12/18	KX-CD-1218
16/21	KX-CD-1621



KAWASAKI

Engine cc	Model	Year	PUMP Diameter	RECOMMENDED SOLAS IMPELLER			
				SERIES	STOCK Engine	LIMITED Engine	MODIFIED Engine
1498	ULTRA 310X/310X SE/310LX/310R	2014~	160mm	CONCORD	KR-CD-14/21	KR-CD-14/21, KR-CD-15/22	KR-CD-15/22
	ULTRA 300X / 300LX	2011-2014	160mm	CONCORD	KR-CD-14/21	KR-CD-14/21, KR-CD-15/22	KR-CD-15/22
	ULTRA 260X/260LX	2008-2010	160mm	CONCORD	KX-CD-15/23	KX-CD-15/23, KX-CD-16/24	KX-CD-16/24
	ULTRA 250X	2007-2008	155mm	CONCORD	KX-CD-15/23, KX-CD-16/21	KX-CD-15/23, KX-CD-16/24	KX-CD-16/24
	ULTRA LX	2007~	155mm	CONCORD	KX-CD-10/16	KX-CD-10/16	
1199	STX-15F	2004~	148mm	CONCORD	KG-CD-14/21	KG-CD-14/21	KG-CD-15/21
	STX-12F	2003-2007	148mm	CONCORD	KG-CD-13/19	KG-CD-13/19	KG-CD-14/20
1176	ULTRA 150	99-2006	Tapered	DYNAFLY	KH-DF-16/20	KH-DF-16/20	KH-DF-17/21
	1200 STX-R	2002-2006	148mm	CONCORD	KG-CD-15/21	KG-CD-15/21	KG-CD-16/22
1071	1100 STX DI	2001-2003	148mm	CONCORD	KG-CD-13/19	KG-CD-13/19	KG-CD-14/20
				X Props	KG-SC-X(16.5-24)	KG-SC-X(16.5-24)	KG-SC-X(17-24.5)
	1100 STX	97-98	CONCORD	KG-CD-13/19	KG-CD-13/19	KG-CD-14/20	
			X Props	KG-SC-X(16.5-24)	KG-SC-X(16.5-24)	KG-SC-X(17-24.5)	
1100 ZXI	96-2003	CONCORD	KG-CD-13/19	KG-CD-13/19	KG-CD-14/20		
		X Props	KG-SC-X(16.5-24)	KG-SC-X(16.5-24)	KG-SC-X(17-24.5)		
891	900 STX	2001-2006	148mm	CONCORD	KG-CD-12/18	KG-CD-12/18	KG-CD-13/19
	900 STX / STS / ZXI	95-2000	140mm	X Props	KF-SC-X(16-23)	KF-SC-X(18-23.5)	KF-SC-X(19-25)
782	800 SX-R	2003-2011	140mm	IJK SERIES	KF-SC-I(16-21)	KF-SC-I(16-21)	KF-SC-I(17-22)
				DYNAFLY	KP-DF-13/22	KP-DF-14/23	KP-DF-14/23, 15/24
743	750 Sxl Pro	95-2002	140mm	CONCORD	KE-CD-09/15	KE-CD-11/16	KE-CD-11/16
				X Props	KE-SC-X(14-21)	KE-SC-X(14-21)	KE-SC-X(14-21)
				IJK SERIES	KE-SC-S(13-18)	KE-SC-S(13-18)	KE-SC-S(14-19)
	750 STS	95-2001	CONCORD	KE-CD-11/16	KE-CD-12/18	KE-CD-12/18	
			X Props	KE-SC-X(14-21)	KE-SC-X(14-21)	KE-SC-X(16-23)	
			IJK SERIES	KE-SC-S(13-18)	KE-SC-I(14-19)	KE-SC-J(15-20)	
	750 Xi Sport	93-2000	CONCORD	KE-CD-11/16	KE-CD-12/18	KE-CD-12/18	
			X Props	KE-SC-X(14-21)	KE-SC-X(14-21)	KE-SC-X(16-23)	
			IJK SERIES	KE-SC-S(13-18)	KE-SC-I(14-19)	KE-SC-J(15-20)	
	750 ZXI	95-97	CONCORD	KE-CD-11/16	KE-CD-12/18	KE-CD-12/18	
X Props			KE-SC-X(14-21)	KE-SC-X(14-21)	KE-SC-X(16-23)		
IJK SERIES			KE-SC-S(13-18)	KE-SC-I(14-19)	KE-SC-J(15-20)		
750 Xi	93-97	CONCORD	KE-CD-11/16	KE-CD-12/18	KE-CD-12/18		
		X Props	KE-SC-X(14-21)	KE-SC-X(14-21)	KE-SC-X(16-23)		
		IJK SERIES	KE-SC-S(13-18)	KE-SC-I(14-19)	KE-SC-J(15-20)		
750 SS	92-97	CONCORD	KE-CD-09/15	KE-CD-11/16	KE-CD-11/16		
		ABC SERIES	KE-SC-A(13-18)	KE-SC-B(14-19)	KE-SC-C(15-20)		
		IJK SERIES	KE-SC-S(13-18)	KE-SC-I(14-19)	KE-SC-J(15-20)		
750 SXI	95-96	CONCORD	KE-CD-11/16	KE-CD-12/18	KE-CD-12/18		
		ABC SERIES	KE-SC-A(13-18)	KE-SC-B(14-19)	KE-SC-C(15-20)		
		IJK SERIES	KE-SC-S(13-18)	KE-SC-I(14-19)	KE-SC-J(15-20)		
750 SX	92-96	CONCORD	KE-CD-11/16	KE-CD-12/18	KE-CD-12/18		
		ABC SERIES	KE-SC-A(13-18)	KE-SC-B(14-19)	KE-SC-C(15-20)		
		IJK SERIES	KE-SC-S(13-18)	KE-SC-I(14-19)	KE-SC-J(15-20)		
750 XiR	94	CONCORD	KE-CD-11/16	KE-CD-12/18	KE-CD-12/18		
		ABC SERIES	KE-SC-A(13-18)	KE-SC-B(14-19)	KE-SC-C(15-20)		
		IJK SERIES	KE-SC-S(13-18)	KE-SC-I(14-19)	KE-SC-J(15-20)		
750 ST	93-95	CONCORD	KE-CD-11/16	KE-CD-12/18	KE-CD-12/18		
		ABC SERIES	KE-SC-A(13-18)	KE-SC-B(14-19)	KE-SC-C(15-20)		
		IJK SERIES	KE-SC-S(13-18)	KE-SC-I(14-19)	KE-SC-J(15-20)		
635	650 TS / 650 SX	87-98	140mm	IJK SERIES	KA-SC-I(13-18)	KA-SC-I(13-18)	KA-SC-J(14-19)
	650 X-2 / 650JM	91-96	ABC SERIES	KA-SC-A(13-18)	KA-SC-B(14-19)	KA-SC-C(15-20)	
			IJK SERIES	KA-SC-I(13-18)	KA-SC-I(13-18)	KA-SC-J(14-19)	
550	550 SX	90-96	Tapered	ABC SERIES	KD-SC-A(13-18)	KD-SC-B(14-19)	KD-SC-B(14-19)
	550 JS	82-89	ABC SERIES	KB-SC-A(13-18)	KB-SC-B(14-19)	KB-SC-B(14-19)	
440	440 JS	77-94	121mm	ABC SERIES	KC-SC-A(13-18)	KC-SC-B(14-19)	KC-SC-B(14-19)

Note: KG-CD-14/21 is the recommended impeller for KAWASAKI STX 15F (4-STROKE).



YUKIKO KUME AND YUJI SHIROKI
SHOW OFF YUKIKO'S WORLD
CHAMPIONSHIP POSTER AT THE
HOT PRODUCTS 2015 IJSBA
MARK HAHN MEMORIAL HAVASU
300 ENDURANCE RACE BANQUET
IN LAKE HAVASU CITY, ARIZONA.



SOLAS®
Where speed begins

SOLAS 12-VANE PERFORMANCE PUMP FOR KAWASAKI

The Solas Kawasaki High Performance 12 Vane Pump is a stainless steel vane, 140mm diameter with 75mm bearing carrier, pressed into an aluminum housing. It is a "Standard Position" pump, meaning, it is not set back, and you can use your existing driveshaft (no extended shaft necessary).

It comes complete with bearings, seals, pump shaft, and tail cone and to top it off, an adjustable diameter drop nozzle system!

The pump fits the 2003-2012 Kawasaki 800 SXR. It also fits the 1992-2002 750 models SX, SXi, SXi Pro, SS, ST, Xi, and XiR.

This pump kit does not include an impeller, trim system cable, or lever, we suggest using either the Solas KP-DF impeller, or the Skat-Trak C-75 Magnum Swirl impeller.

These pumps really improve rough water performance, and they fit right up to the hull like an OEM pump.

Description	Part No.
Solas 12 Vane Performance Pump with Trim System for Kawasaki	KPS-PM-140/74T
Solas 12 Vane Performance Pump Seal and Bearing Kit	08-KPS

SOLAS COMPLETE PUMP ASSEMBLY FOR HYDROSPACE S4

Description	Part No.
Pump Assembly for HydroSpace S4	HS-PM-140/74T

See page 96 for more information.



155MM YAMAHA PUMP SEAL

Fits both OEM Yamaha and Skat-Trak Billet Magnum Pumps

Description	Part No.
R&D 155mm Yamaha Pump Seal	162-70800
Thrust Innovations 155mm Yamaha Pump Seal	TI-155-PMP-SL



SOLAS STAINLESS STEEL YAMAHA 12-VANE STATOR SECTION

Get HUGE gains in Hook Up on bottom end, and overall efficiency in rough conditions, and jet wash! This pump is a must have for Freestyle! The Brand New Solas Yamaha 144mm 12 Vane Pump Stator is now available and is an incredible value for the HUGE performance gain resulting from bolting this pump on!

This is the stator section only, is stainless steel, with large diameter bearing carrier, and a 12 vane standard position design. It replaces the stock Yamaha 144mm 6 vane aluminum stator section. No need to buy an expensive extended shaft with this pump conversion.

You will need a large hub design impeller such as the Impros Hooker impeller, the Solas Concord YQ-CD, or Skat-Trak C+75 Swirl impeller with this pump.

Solas 2016 YQS-SV-144/74 Production Update:

The new production of the Solas 144 Yamaha stator have been updated so that it is no longer required to use a Impros Pump Spacer Ring part# IMYQ-NS. The pump sealing ring on the rear of the 2016 Solas 144 Yamaha stator has been widened to 6.61mm wide, Hot Products recommend you seal the stator section to the reduction nozzle using 1 Minute Gasket, Right Stuff or a similar product to prevent any possible leaking when the pump is under pressure.

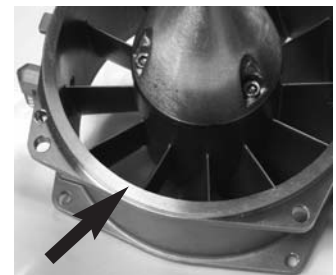

The 2015 and earlier Solas 144 Yamaha stator has a 3.00mm pump sealing ring on the rear of the stator section, if you have a stator from this production it will require the use of a Impros Pump Spacer Ring part# IMYQ-NS.

Solas 144 Yamaha Parts	Part No.
Stainless Steel Yamaha 12-Vane 144mm Stator	YQS-SV-144/74
Stainless Steel Yamaha 144mm Pump Housing	YBS-HS-144
A. Impros 144mm Pump Spacer	IMYQ-NS
<i>(See production update detailed above)</i>	
B. Impros Freestyle Tail Cone	IMYQ-FC
WSM Yamaha Pump Bearing & Seal Kit	003-630

Solas 148 Yamaha Parts	Part No.
Stainless Steel Yamaha 12-Vane 148mm Stator	YRS-SV-148/74
Stainless Steel Yamaha 148mm Pump Housing	YRS-HS-148
WSM Yamaha Pump Bearing & Seal Kit	003-630

Solas Impeller for 148mm Housing	Part No.
Concord 12/18	YRS-CD-1218
Concord 13/19	YRS-CD-1319
Concord 14/20	YRS-CD-1420

See page 217 for additional Solas Stators and Pump Housings.

FOUR STROKE
INTAKE SYSTEMS
ENGINE/GASKETS
EXHAUST
DRIVE LINE HANDLING
ELECTRICAL
WATERLINE /BILGE
STEERING & CONTROLS
BODY
ACCESSORIES
SERVICE TOOLS /HARDWARE
CHEMICAL

FOUR STROKE
INTAKE SYSTEMS
ENGINE/GASKETS
EXHAUST
DRIVE LINE HANDLING
ELECTRICAL
WATERLINE /BILGE
STEERING & CONTROLS
BODY
ACCESSORIES
SERVICE TOOLS /HARDWARE
CHEMICAL



YAMAHA HOOKER IMPELLERS

The New Impros Hooker 144mm impeller for the Yamaha is a 3 blade large hub diameter, radial edge design polished stainless steel impeller designed and intended for Bottom end and "Hook up" for freestyle and freeriders on a Superjet, Blaster, or similar ski that utilizes the 144mm pump and want maximum AIR for tricks.

We gave it this name because it "Hooks Up" so well. Designed around maximizing pump efficiency and bottom end, this is a new radial edge design, large hub (75mm), and is set back 7mm (4mm further than we can go with a small hub impeller). It is a highly polished Yamaha impeller that we will have available for the 144mm stock pump, and 144/142/140mm Magnum pump.

Designed with a steep root angle to load the pump well. Material is a 17-4 stainless steel cast. Dynamically balanced, and comes mirror polished, with an impeller tool and rubber nose seal.

We offer it available in a variety of pitches for different engine set ups. The pitches available are 9/15, 10/16 and 11/17. These numbers are much different from other impeller pitches you have heard of. While they are very low, and directed at bottom end "Hit", the root angle, blade length and other geometric differences set the Hooker apart from the others. We also produce "more aggressive" custom pitch Hookers for engines that require it, for an additional charge.

Recommendation	Part No.
Stock, Limited, Maximum Bottom End	IMY144915
Limited with Porting, Big Carb., More Top End	IMY1441016
Closed Course Race with Pipe, Max. Hookup, Added HP/Performance	IMY1441117

KAWASAKI 750/800 HOOKER IMPELLERS

The New Impros Hooker 140mm impeller for the Kawasaki 140mm pump is a 3 blade large hub diameter, radial edge design polished stainless steel impeller designed and intended for Bottom end and "Hook up" for freestyle and freeriders on an SXR, SXi Pro, or SX that utilizes the 140mm pump and want maximum AIR for tricks. We gave it this name because it "Hooks Up" so well. Designed around maximizing pump efficiency and bottom end, this is a new radial edge design, large hub, and is set back.

It is a highly polished Kawasaki impeller that we will have available for the 140mm stock pump used in the SXR 800, 750, and the Kawasaki 650 pump. Designed with a steep root angle to load the pump well. Material is a 17-4 stainless steel cast. Dynamically balanced, and comes polished, with a rubber nose seal.

The Hooker is available in 9/15 and 10/16 pitch. These numbers are much different from other impeller pitches you have heard of. While they are very low, and directed at bottom end "Hit", the root angle, blade length and other geometric differences set the Hooker apart from the others. We also produce "more aggressive" custom pitch Hookers for engines that require it, for an additional charge. Further set-back increases the pump efficiency, along with the larger hub and blade length. We're excited about how this impeller works compared to the other popular repitched impeller versions that have become so popular. **These Impros impellers are special order.*

Recommendation for Kawasaki 750/800 Pump	Part No.
Stock, Limited, Maximum Bottom End	IMK140915
Limited with Porting, Big Carb., More Top End	IMK1401016

Recommendation for Kawasaki 650 Pump	Part No.
Stock, Limited, Maximum Bottom End	IMKA140915
Limited with Porting, Big Carb., More Top End	IMKA1401016

IMPROS CUSTOM MODIFIED SOLAS IMPELLERS



KAWASAKI 800 SXR IMPROS CUSTOM SOLAS SET BACK IMPELLERS

Impro's Set Back impellers are custom pitched to maximize performance & engine rpm for specific applications. These Solas Dynafly impellers are machined -5mm to set them closer to the pump vanes, which maximizes pump hook up. The impellers fit right into stock SXR pump.

**These Impros impellers are special order.*

Race Class	Description	Part No.
Freestyle	13/19 Solas Dynafly -5mm	KPDF1319SB
Stock	13/21 Solas Dynafly -5mm	KPDF1321SB
Limited	13/23 Solas Dynafly -5mm	KPDF1323SB
Modified	14/24 Solas Dynafly -5mm	KPDF1424SB

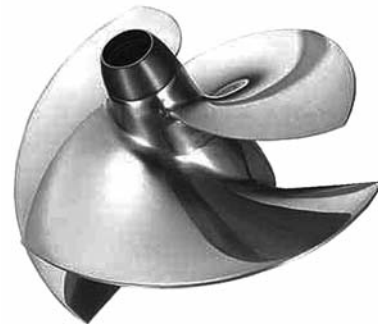

YAMAHA SUPERJET FREESTYLE IMPROS CUSTOM SOLAS SET BACK IMPELLERS

Impro's set back custom pitched impellers are modified to maximize bottom end and get the most air out of your ski! These impellers work with the stock pump, with & without the TBM Super Pump Cone.

**These Impros impellers are special order.*

Race Class	Description	Part No.
Freestyle	13/15 Solas Concord -3mm	YBCD1315SB
Stock/Ltd.	13/15 Solas Concord -3mm	YBCD1315SB
Modified	13/16 Solas Concord -3mm	YBCD1316SB

IMPELLER/DRIVESHAFT HOLDER AND REMOVAL TOOL



Sea-Doo **Part No.**
A. 580/650/720/800/951 All **TOOL#23**
 18mm spline, 18 tooth

Polaris **Part No.**
B. Polaris ALL & long reach univ. **TOOL#38**
 20mm spline, 20 tooth

Kawasaki **Part No.**
A. 650/750/800/900/1100 & **TOOL#23**
 Ultra 250/260/300
 18mm spline, 18 tooth
C. 550-89 **TOOL#24**
 14mm spline, 6 tooth



Sea-Doo **Part No.**
D. GTX 4Tec Super Charged **TOOL#70**
 22mm spline, 22 tooth



Sea-Doo **Part No.**
E. RXP/RXT 27MM **TOOL#71**
 27mm spline, 28 tooth



Yamaha **Part No.**
F. WR500, WJ650LX **TOOL#27**
 16mm spline, 14 tooth



Yamaha **Part No.**
G. 650/701/760/1100/1200 **TOOL#32**
 18mm spline, 16 tooth



Yamaha **Part No.**
H. GP1200R **TOOL#56**
 20mm spline, 18 tooth
 SHO/FZR/FZS **TOOL#53**
 22mm spline, 20 tooth



SOLAS RXP/RXT IMPELLER HOLDER TOOL

Sea-Doo **Part No.**
 RXP/RXT 27mm spline **WR012-SRX**



Yamaha
 162-00701

Kawasaki
 161-00801

R&D AFTERBURNER PUMP CONE SLEEVE/ADJUSTABLE CONE KIT

Transform the O.E.M Kawasaki SXR 800 Pump or O.E.M. Superjet Pump into a high performing large hub, high pressure axial flow design inexpensively with the exclusive R&D Large Hub Afterburner Pump Core sleeve and adjustable Anti-cavitation Pump Cone Kit design. Experience much better hole shots and 1 mph plus gains in top speed performance with the added pump efficiency and thrust. The Afterburner Pump Core will drastically increase pump hook up and rear end traction. The innovative and superior R&D design allows impeller changes to be made easily in minutes. The Afterburner Anti-cavitation rear cone length is tunable with kit supplied spacer shims which allows custom peak RPM tuning for any brand or pitch of impeller. Better holeshots, hook up, top speed, tunability.

Description	Part No.
Kawasaki SXR800 and 750 (1992-06)	161-00801*
Yamaha SuperJet (All Years)	162-00701*

Fits Yamaha 144 Pumps Only.

*R&D pump cones require a 75mm large hub impeller.

WATCON IMPELLER PITCH GAUGES

It's a known fact; not all impellers are created equal. Sometimes when impellers are mass produced, there are subtle differences that can affect performance. Use this simple tool to measure the pitch angle and blade length of each blade throughout its circumference. This enables you to make adjustments to the pitch where needed. Great for fine tuning, making minor changes or verifying pitch when sending impellers off for repair.

Description	Part No.
140-142mm Impeller Pitch Gauge	IMP-142
144-148mm Impeller Pitch Gauge	IMP-148
155-160mm Impeller Pitch Gauge	IMP-160



SXR 800 AFTERBURNER TUNABLE PUMP CONE FOR SKAT-TRAK PUMPS

The new R&D Afterburner Pump Cone for all Skat-Trak SXR 800 Pumps allows for custom peak rpm tuning. With the kit supplied spacer shims you can now fine tune the pump for maximum RPM and speed!

Description	Part No.
SXR 800 Afterburner Tunable Pump Cone for Skat-Trak Pumps	161-00804

FOUR STROKE
 INTAKE SYSTEMS
 ENGINE/GASKETS
 EXHAUST
 DRIVE LINE HANDLING
 ELECTRICAL
 WATERLINE /BILGE
 STEERING & CONTROLS
 BODY
 ACCESSORIES
 SERVICE TOOLS /HARDWARE
 CHEMICAL

FOUR STROKE
INTAKE SYSTEMS
ENGINE/GASKETS
EXHAUST
DRIVE LINE HANDLING
ELECTRICAL
WATERLINE /BILGE
STEERING & CONTROLS
BODY
ACCESSORIES
SERVICE TOOLS /HARDWARE
CHEMICAL

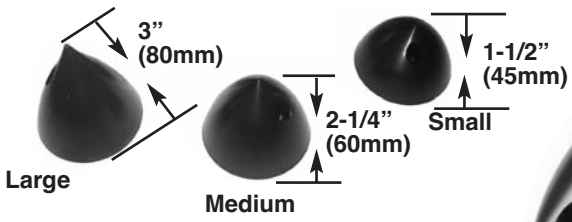
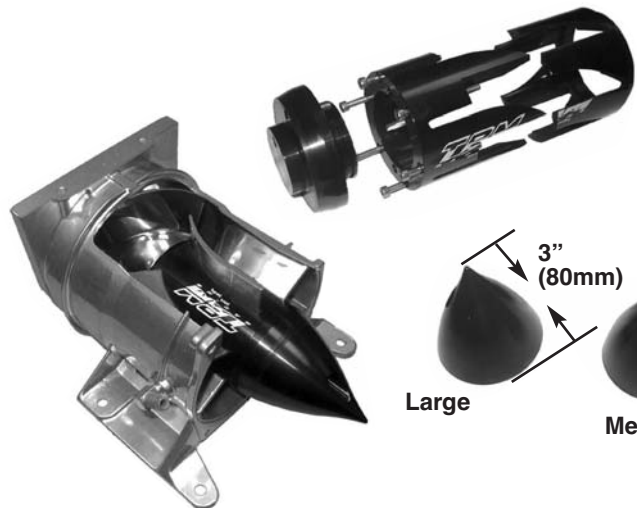

TBM RACING SUPER PUMP CONE "PRO" KAWASAKI 750/800

TBM has increased the hub diameter of the OEM pump, which creates an increase in pump pressure keeping the pump "loaded" in rough water conditions. The increased efficiency adds amazing acceleration, improved handling and top speed. The Super Pump Cone is designed to be used with the OEM, Solas Dynafly, or C-75 Skat-Trak impellers in standard, or a 5mm set back. Installation is as simple as changing an impeller and can be performed with standard tools. Fits 1992-2012 Kawasaki 750/800 stand ups.

Included with the "Pro" kit is the Super Pump Cone insert, a tail cone base that seals the pump and three different length tail cone tips. The cone tips can be changed by simply removing one M6 bolt and replacing the tip with a different length to optimize your impeller and nozzle combination. The short cone works for Freestyle, Freeride and tight Closed Courses, while the medium and long tail cone works excellent for rough water hook up and amazing top speed.

Kawasaki	Part No.
Super Pump Cone (Kawasaki)	TBM120

TBM RACING YAMAHA SUPER PUMP CONE

Our Yamaha Super Pump Cone will transform your inefficient OEM pump into a high performance large diameter hub race pump. It is not necessary to run a large hub impeller, so there is no need to purchase a new impeller to benefit from our Yamaha Super Pump Cone. We have designed our Yamaha Super Pump Cone to accommodate any diameter hub impeller. An OEM, standard aftermarket, or C-75 Magnum impeller will work with this set up.

Three sizes of our interchangeable tail cone tips are included with this kit. Outstanding for racing, freestyle or freeride applications. The Yamaha Super Pump Cone will work on any year Yamaha Super Jet, Wave Blaster and any other Yamaha watercraft models that utilize a Yamaha 144mm pump housing.

Yamaha	Part No.
Super Pump Cone (Yamaha)	TBM120-YAM



TBM RACING ULTRA VANE EXTENDING TAIL CONE

With the four vane extenders integrated into the tail cone the turbulent water in the pump is controlled and straightened for a longer distance. They also centered the tip of the tail cone in the bore of the nozzle to even the pressures inside the compression nozzle. All this translates to improved hook up, acceleration and a noticeable gain in top speed. Installation could not be easier and we also powder coat the tail cone for corrosion prevention.

Description	Part No.
TBM Racing Ultra 250/260/300X or LX Ultra Vane Extending Tail Cone	TBM120-UL



TBM RACING YAMAHA FZR/FZS/SHO SUPER PUMP CONE

TBM's Super Pump Cone increases the hub diameter and smooths the transition of water flow through the rough casting of the OEM stator vane assembly. This drastically improves hook up, acceleration and top speed on stock Waverunners although performance is enhanced exponentially as engine modification is increased. TBM has designed the Super Pump Cone to match the stock impeller; however any 75mm diameter hub aftermarket impeller will work. TBM's Super Pump Cone will also work in conjunction with Riva's 160mm wear ring/impeller upgrade. The kit comes complete with everything needed for installation with the exception of a spline tool for impeller removal/installation.

Description	Part No.
TBM Racing FZR/FZS/SHO Super Pump Cone	TBM120-FZR



ADJUST-A-THRUST

The only Automatic Transmission for PWC Jet Pumps Maximize Your Performance



In low gear the shuttle lets a large volume of water be moved to accelerate the craft.



As speed and pump pressure increase, the shuttle is forced out into the exit nozzle, reducing its size and increasing water velocity. This increases top speed.

Kawasaki	Part No.
1100 ZXI/STX, STXR, STX12F/15F (2004-06)	KAW1
Ultra 250 (2007-08), Ultra 260 (2009-10), Ultra 300 (2011-12), STX15F (2007-12)	KAW4
*This Kit does not contain Bearings & Impeller Shaft	
All 650/750 SXI/750 SXI Pro/SXR 800	KAW3
Skat-Trak Magnum Pump	Part No.
Skat-Trak, Yamaha, Polaris Octane	SKT1
Skat-Trak, Kawasaki/Sea-Doo (75mm hub)	SK27

Yamaha



R&D ANTI-CAVITATION CONE

The unique patent pending design balances the bowl pressure in the last stage of the pump to eliminate detectable cavitation. Improve bottom and punch midrange pull and overall performance.

Yamaha	Part No.
FX140, GP800R/1200R/ GP1300R (all except 2005)	162-12002
XL1200LTD, XLT800/1200	162-12003
FX H.O./VX110/GP1300R (2005 & up)	162-16000
FX-SHO, FZR/FZS, VXR/VXS	162-18000
FZR/FZS (2014)	162-18002

Sea-Doo	Part No.
Pre-2009 GTX/RXT/RXP (185/215 HP)	163-95001
RXP-X, RXT-X	

Kawasaki	Part No.
Ultra 250X/260X/300X/310X	161-25010

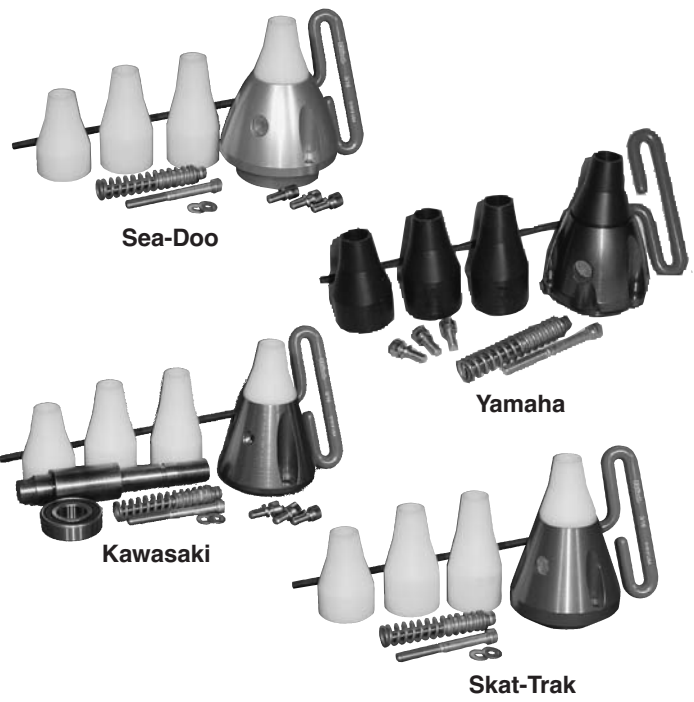

Sea-Doo	Part No.
Sea-Doo 155.5mm Pumps (1998-06) with 951 engine, 3D	SEA2
Sea-Doo 4-Tec 155.8mm 4-Tec Pumps (2001-10)	SEA4
4-Tec N/A, SC, RXP-X, RXT-X	
Sea-Doo RFI Pumps, 140mm Pump with 75mm (1999-01)	SEA5
GSX RFI (1998-01), GTX RFI (1999-01), GTI (non RFI), Speedster SK (1999-00), Challenger SK, Sportster 1800	

Yamaha	Part No.
144mm, 155mm Pumps with Straight Exit Nozzle SJ (1990-06), WRIII (1991-97), GP700,VXR/VXR Pro, Blaster, B2, All Raider (1994-97), GP1200 (1997-99), Venture 1100, XL1200 (1998-99)	YAM1
144mm, 155mm Pumps with Angled Exit Nozzle 3 to 5 deg. GPR 1200 (1999-02), XLT 1200 (1999-02), FX140, GPR1300, GP760, GP800	YAM2
155mm Angled (3 to 5 deg) Pump with 75mm hub.	YAM3
FX HO, FX 160 (2005-06), GPR1300	
All Yamaha PWC with 70mm hub for 1.8 Liter engine	YAM4



WET WOLF FREESTYLE CONE

Freestyle cones are specially designed to maximize low end performance. The small design of the cone also lets the engine rev faster for a more powerful midrange hit. Perfect for Freestyle/Freeride, increases throttle response. CNC machined and Tuff-Coat anodized for superior corrosion resistance.

Yamaha	Part No.
A. Super Jet	FSYAM
Kawasaki	Part No.
B. 800 SXR, 750SX, SXI-Pro, 650	FSKW3
C. Polaris Octane, Yamaha Magnum Pump	FSSKT1

FOUR STROKE
INTAKE SYSTEMS
ENGINE/GASKETS
EXHAUST
DRIVE LINE HANDLING
ELECTRICAL
WATERLINE /BILGE
STEERING & CONTROLS
BODY
ACCESSORIES SERVICE TOOLS /HARDWARE
CHEMICAL



R&D RXP-X/RXT-X 84MM REDUCTION NOZZLE KIT

The R&D RXP-X/RXT-X 84mm Pump Reduction cone will reduce the venturi size from a short O.E.M. 87mm large bore design to a plus .750 over stock venturi length with a final venturi size of 84mm. Increased hook up, stronger acceleration and mid range, improved top speed performance.



Description	Part No.
RXP-X/RXT-X 84mm Reduction Nozzle Kit	173-25584



RIVA SEA-DOO RXP/RXT/GTX-SC BILLET PUMP WEDGE AND VTS EXTENSION ROD

2-Degree wedge trims up your pump nozzle raising the bow of your craft for less drag and more control.

Description	Part No.
RXP, RXP-X, RXT-X, GTS-SC 2-Degree Pump Wedge	RS23050
RXP/RXP-X/RXT-X VTS Extension Rod	RS23050-1-ER

FOUR STROKE

INTAKE SYSTEMS

ENGINE/GASKETS

EXHAUST

DRIVE LINE HANDLING

ELECTRICAL

WATERLINE /BILGE

STEERING & CONTROLS

BODY

ACCESSORIES

SERVICE TOOLS /HARDWARE

CHEMICAL



RIVA PRO-SERIES REDUCTION NOZZLE

Our Pro-Series Reduction Nozzle is ideal for tuning your pump combination to maximize performance.

Nozzle exit diameter can be easily changed via interchangeable ring system. Looking for more RPM or acceleration power? Insert a larger diameter ring. Want more top speed? Install a smaller diameter ring. Nozzle includes three precision-machined stainless steel rings (81/82/83mm) in graduated sizes. Additional ring sizes available.

Description	Part No.
RXP 215/RXP-X 255, RXT (05-07), GTX-SC*	RS23050-N

* NOTE: Not compatible with '09 & newer iControl models. Requires additional machine work for use with non-iControl RXT-X & RXT models.

ADJUSTABLE EXIT NOZZLE AND NOZZLE RING KITS FOR SEA-DOO 650/720/800

Our variety of interchangeable billet machined rings offer to find the maximum performance of the boat. Large ring for bottom-end acceleration and Small ring for top-end. Kit includes 83/85/87mm rings.



Sea-Doo	Part No.
Exit Nozzle with Billet Machined Nozzle Rings 83/85/87mm	54-3313

GTX 4-TEC



R&D SEA-DOO RXT 2.5 DEGREE NOZZLE WEDGE KIT

Extensive testing has led our development team to wedge the reduction nozzle up 2.5 degrees which will inexpensively give your 4-TEC better handling everywhere and provide a boost of 1 to 2 mph in top speed performance. The billet aluminum CNC machined 2.5 degree reduction nozzle wedge kit was designed to work with the OEM O.P.A.S. system and installs easily in 15 to 20 minutes with R&D's "easy install" directions.

Description	Part No.
02-03 GTX 4-TEC SC / 03-05 GTX 4-TEC NA 2.5 Degree Pump Wedge/Cable Extension Kit	143-95002
RXP 215 2.5 Degree Pump Wedge/Cable Extender Kit	143-95003
RXT 215/(04-05) GTX 4-TEC 2.5 Degree Pump Wedge/Cable Extender Kit	143-95004
RXT-X 255 2.5 Degree Pump Wedge/Adjustable Trim Rod/Cable Extender Kit	143-95005
RXP-X 255 1.0 Degree Pump Wedge/Adjustable Trim Rod/Cable Extender Kit	143-95006



R&D ULTRA 250/300 1 DEGREE NOZZLE

Description	Part No.
R&D Ultra 250X/LX, 260X/LX 1° Nozzle Wedge Kit	141-25001
R&D Ultra 300X/LX, 310X/LX 1° Nozzle Wedge Kit	141-30000

INTERCHANGEABLE PUMP CONE ROD FOR YAMAHA

Change the diameter of your exit nozzle with one easy turn of a bolt, you can adjust your exit nozzle diameter by interchanging the various rod sizes.



Description	Part No.
Yamaha SJ, Wave Blaster, 701 Raider	54-3351



WORX KAWASAKI 15F PUMP WEDGE

- 2 Degree billet anodized pump wedge
- Promotes bow lift to increase top speed from 1 to 2 mph
- Higher nose ride height allows for dryer ride
- Cost effective upgrade for better handling and top speed

Description	Part No.
Kawasaki 15F	WR05003



RICKTER RRP 144 PLASTIC PUMP SHOE

144mm Pump Shoe. Fits all Rickter, SuperJet, Wave Blaster and aftermarket hulls. Replaces OEM #6R7-5311-00.

Description	Part No.
Rickter Plastic 144 Pump Shoe	PM-SH-PLAS-144



02-02-432



JD #36

ALUMINUM PUMP SHOES FOR YAMAHA SUPERJET

Aluminum pump shoes are designed to replace the stock plastic unit which is prone to fail with a winged intake grate. These aluminum pump shoes have a completely redesigned front entrance compared to the OEM plastic pump shoe allowing water to feed into the pump more efficiently. Improves hookup, cornering, stability, rough water speed and overall handling.

Blowsion Pump Shoe - this part will require the 4 mounting holes for the hull be drilled and the 2 intake grate rear mounting holes be drilled and tapped. Minimal fitting to the hull is required.

Jet Dynamics Pump Shoes – these parts come predrilled for the hull mounting holes and predrilled and tapped for the intake grate rear mounting. These pump shoes will require proper fitting for installation to the hull.

Description	Part No.
Blowsion Yamaha SuperJet (All), Waveblaster, Polaris Octane, Pump Intake Shoe.	02-02-432
Jet Dynamics SuperJet 96+ OEM Replacement Aluminum Pump Ring	JD#36
Jet Dynamics Yamaha 155mm Pump Shoe	JD#155
Jet Dynamics Yamaha 160mm Pump Shoe	JD#160



RICKTER RRP 155 ALUMINUM PUMP SHOE

This pump shoe has been developed by Rick Roy for a clean, fast and easily installation. Fits all RICKTER and aftermarket Yamaha based hulls

Description	Part No.
Rickter Aluminum 155 Pump Shoe	PM-SH-AL-155



WORX RACING 144 ALUMINUM PUMP SHOE

WORX Racing cast aluminum pump shoe is a direct replacement for the stock plastic pump shoe that easily distorts and breaks under high speeds in race

applications or under huge load from freestyle engines. Pre-drilled and tapped for easy installation this is a must have upgrade for your modified stand up to allow use of large-winged aftermarket intake grates that provide maximum efficiency to your jet pump without sacrificing reliability. Suits all Yamaha SuperJets and most aftermarket hulls.

Description	Part No.
WORX Aluminum 144 Pump Shoe	WR06009



JET DYNAMICS ALUMINUM PUMP SHOE FOR KAWASAKI 800SXR

Installation fitting is required

Description	Part No.
800SXR, 750 SX Pump Shoe	JD#55



2015 THRUST INNOVATIONS DAYTONA FREERIDE. PHOTO COURTESY OF YVES CARIGNAN OF RRP.

FOUR STROKE	INTAKE SYSTEMS	ENGINE/GASKETS	EXHAUST	DRIVE LINE HANDLING	ELECTRICAL	WATERLINE /BILGE	STEERING & CONTROLS	BODY	ACCESSORIES	SERVICE TOOLS /HARDWARE	CHEMICAL
-------------	----------------	----------------	---------	---------------------	------------	------------------	---------------------	------	-------------	-------------------------	----------



113-95008
RXP-X 260
(2012+)



113-95007
RXP-X 255
RXT-X 255



112-18021
VXR Pro 2



112-18020
VXR

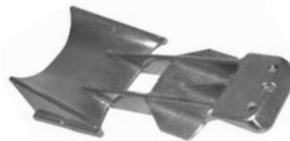

112-18001
FZR



112-18010

**FOUR
STROKE**

**INTAKE
SYSTEMS**

**ENGINE/
GASKETS**

EXHAUST

**DRIVE LINE
HANDLING**

ELECTRICAL

**WATERLINE
/BILGE**

**STEERING
& CONTROLS**

BODY

ACCESSORIES

**SERVICE TOOLS
/HARDWARE**

CHEMICAL

Sea-Doo	Part No.
ALL SP/SPX/SPI/GT/91-96 XP/94 XPI/ 92-95 GTX/92-00 GTS/96 GTI	113-00000
HX 95-97 Pro 2	113-72710
96-97 GSX/96-97 GTX/97 GSI/97-01 GS/ 97-01 GS/97-00 GTI/98-02 GTX RFI/99-00 GSX RFI	113-80400
97-99 GSX LTD/98-99 GTX LTD/ 00-02 GTX/00-01 GTX DI/00-01 LRV/02 LRV DI	113-80401
XP97	113-00001
98-99 XP LTD/00-02 XP/00-02 RX/ 00-03 RX DI/RXX/03+ XP DI	113-00002
*for use with R&D Ride Plate pt# 123-80620 (Aquavein has extended tabs that lock into the R&D Ride Plate to remove stress from stock inserts).	
98-99 XP LTD/00-02 XP/00-02 RX/00-03 RX DI/ RXX/03+ XP DI *for use with stock ride plate.	113-00003
01 GTS/01-05 GTI/02-05 GTI LE/ 04 GTI LE RFI/04-05GTI RFI/04-05 3D	113-00003
*for use with stock ride plate.	
02-09 GTX 4-TEC All Models,	113-95000
08-09 GTX 155/215, 07-08 GTX Ltd, 07-08 GTX Std & Wake, 02-03 GTX DI, 09 Wake Pro	
RXP 215/155	113-95001
RXP 215 PRO 2 AQUAVEIN & GIRDLE KIT	113-95002
RXP 215 GIRDLE KIT Only	123-10010
RXP-X 255, RXT-X 255	113-95004
GTI 06-09	113-95003
RXP-X 255/RXT-X 255 Pro 2	113-95007
Deep Closed Course Race	
09 GTXis, GTX is LTD 260 (10+),	113-95006
RXT is 260 (10-12), RXT-X 260 (10-13)	
RXP-X 260 (2012+) (T3)	113-95008
Spark	113-96001



111-80001
800 SXR

Kawasaki	Part No.
440/550 all years	111-55100
650 SX/X2	111-65100
750 SX/SXI	111-75101
750 SXI Pro 98-02	111-75102
750/900/1100ZXI (99 only STX/pre 00-1100 STX)	111-75500
Ultra 150 All	111-15000
1200 STXR /15F Pro 2	111-12100
*for use with R&D Ride Plate #121-12001	
15F/12F/STXR/STXR DI	111-15001
*for use with stock or R&D Ride Plate pt#121-15100	
800 SXR STEALTH series	111-80001
Ultra 250X/LX (07-08), 260X/LX (09-10)	111-25000
Ultra 300X/LX (11-13), 310X/LX (14)	111-30000

Yamaha	Part No.
Super Jet (96-07)	112-70102
Super Jet (96-07) Double Deep PRO 2	112-70105
Super Jet (96-07) Limited Race	112-70106
Super Jet (2008)	112-70108
701 & 760 WaveRds/Rds Deluxe 701/Venture 95-96	112-70300
GP1200 97-99, XL 700/760. XL 1200 98	112-12000
GP760/800 98-00	112-70301
XL1200 LTD/XL 800/SUV/XLT 800 & 1200	112-12001
GP1200R/GP 1300R all	112-12002
GP1200R/GP1300R (single bar)	112-12100
GP800R All (2009-13)	112-00800
FX140/FX H.O.	112-14000
V1 (2016) VX110 (2007-14)*	112-00110
FX SHO, FX SHO CRUISER H.O. 08-11	112-18000
FZR/FZS (2009-13)	112-18001
FZR/FZS (2014)	112-18004
VXR/VXS	112-18020
FX HO (2012+)/FX Cruiser HO/ FX SHO (2012+), FX-SVHO	112-18010
VXR/VXS Pro2	112-18021
* Does not fit 2015	

Honda	Part No.
F12X 1200 T3	115-12003

Polaris	Part No.
All (Except 750/Hurricane)	114-65100
750 SL/SLT 50/Hurricane	114-75100



WATCON INTAKE/SCOOP GRATE DEPTH GAUGE



Most savvy tuners are sure to set their intake grates to the maximum IJSBA allowed limits for the best hook-up possible. Watcon's "Depth Gauge" has been manufactured to the Official IJSBA Rule Book specifications.

Description	Part No.
Watcon Intake Scoop Grate Depth Gauge	IJSBA-1

***THE WATCON DEPTH GAUGE HAS BEEN MANUFACTURED TO THE SPECIFICATIONS IN THE IJSBA RULE BOOK, ALL FINAL DECISIONS ON THE LEGAL DEPTH ARE THE DECISION OF EACH RACE DIRECTOR AND THE TECHNICAL INSPECTOR FOR EACH RACE SITE.**



R&D PUMP PLUG KIT

Pump stuffer kit stuffs up all those unwanted cavities in the pump shoe that aid in producing cavitation. Reducing cavitation equals greater performance.

Yamaha	Part No.
GP1200R, GP800R, GP1300R	162-00000
XL1200LTD, XLT800/1200	162-00001
FX140, FX140 H.O. (160 HP)	162-00002
VX110 for Stock Intake Grate Applications	162-00110
VX110 for R&D Intake Grate Applications	162-00111
FX SHO Pump Shoe Seal Kit (OEM Scoop Grate)	162-00003
FX SHO Pump Shoe Seal Kit (RIVA Scoop Grate)	162-00004
FX SHO Pump Shoe Seal Kit (R&D Scoop Grate)	162-00005
FZR/FZS Pump Shoe Seal Kit (OEM Scoop Grate)	162-00006
FZR/FZS Pump Shoe Seal Kit (R&D Scoop Grate)	162-00007
VXR Pump Seal Kit For Stock Scoop Grate	162-00008
VXR Pump Seal Kit for R&D Aquavein Intake Grate	162-00009
FX SHO (2012)/FX Cruiser Pump Shoe Seal for R&D Grate	162-00010
FX SHO (2012)/FX Cruiser Pump Shoe Seal for OEM Grate	162-00011

Kawasaki	Part No.
750/800 Stand-Up	161-80000
Ultra 250/260 Pump Shoe Seal Kit	161-25000
Ultra 300/310 Seal Kit for OEM Intake Grate	161-30000
Ultra 300/310 Seal Kit for R&D Aquavein Intake Grate	161-30001

Sea-Doo	Part No.
Spark Seal Kit for OEM Intake Grate	163-81900
Spark Seal Kit for R&D Aquavein	163-81901



FX-SHO - RY25040

FZR/FZS - RY25050

RIVA PUMP SEAL KITS

Dramatically reduce cavitation and prop spin with our easy to install Pump Seal Kits. Location specific, molded inserts fill the voids in OEM pump inlet shoe that bleed air into pump causing cavitation. Recommended for modified craft using aftermarket intake grates. Includes detailed installation instructions.

Yamaha	Part No.
FX-SHO Pump Seal Kit for RY22040	RY25040
FZR/FZS Pump Seal Kit for RY22050-1	RY25050
VXR/VXS Pump Seal Kit for RY22060	RY25060
FZ SVHO Pump Seal Kit for RY22051	RY25051
FX SHO/SVHO Pump Seal Kit for RY22070	RY25070

Sea-Doo	Part No.
Spark Pump Seal Kit for RS22130	RS25130



RIVA TOP LOADER INTAKE GRATE

Sea-Doo	Part No.
RIVA RXP 215 (04-08)	RS22050
RIVA RXT 215 (05-08)/GTX-SC (03-04)	RS22055
RIVA RXP-X 255/RXT-X 255HP (Non-iControl Model)	RS22080
RXT/GTXC, RXT-X 260/300 (S3 Hull) (Stainless Steel)	RS22090
RXP-X 260/300 (Stainless Steel)	RS22110
Spark	RS22130

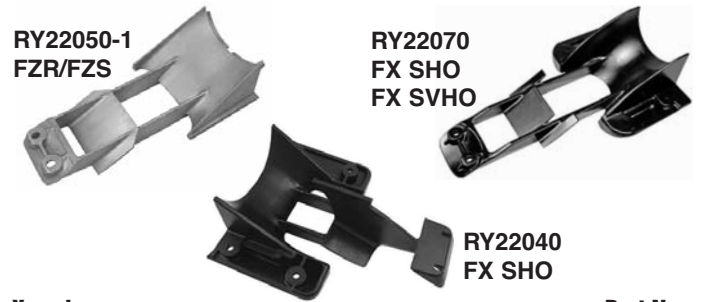

Yamaha	Part No.
FX140, FXHO	RY22325
FX SHO, FX SHO Cruiser (2008-11)	RY22040
FZR/FZS (Stainless Steel)	RY22050-1
FX SHO/FX SVHO (2012-15)	RY22070
FZR/FZS/FZ SVHO (2014-16)	RK22051

Kawasaki	Part No.
Ultra 300/310 Turnable Top Loader	RK22100



TBM100-UL Ultra	TBM100-UL3 Ultra 300/310	TBM100-FZR FZR/FZS
-----------------	--------------------------	--------------------

TBM SUPER SCOOPS

Description	Part No.
TBM Sea-Doo RXP/RXT Super Scoop	TBM100-SD
TBM Yamaha FZR/FZS Tunable Super Scoop	TBM100-FZR
TBM Yamaha FZR/FZS (2014-15) Super Scoop	TBM100-FZR-2
TBM Kawasaki SX-R 800 Super Scoop	TBM100
TBM Kawasaki Ultra Tunable Super Scoop	TBM100-UL
TBM Kawasaki 300/310 Ultra Tunable Scoop	TBM100-UL3

FOUR STROKE
INTAKE SYSTEMS
ENGINE/GASKETS
EXHAUST
DRIVE LINE HANDLING
ELECTRICAL
WATERLINE /BILGE
STEERING & CONTROLS
BODY
ACCESSORIES
SERVICE TOOLS /HARDWARE
CHEMICAL



WR223 Sea-Doo

WORX

RACING COMPONENTS



WR225 Kawasaki

WORX RACING INTAKE GRATES

Sea-Doo	Part No.
HX (All), GTS (1993-01), GTX (1993-95) GTI (1993-95)	WR206
SP, SPI (1992-96), SPX (1996-99), XP (1996)	WR207
GSX, GS, GSI (All), GTX (1996-97), GTI (1997-01) GSX-RFI, GTX RFI (1998-02)	WR208
XP, XP LTD, XP DI (1997-04)	WR211
GSX LTD (All), GTX, GTX LTD (1998-01)	WR212
GTX, DI (2000-01)	
RX (All), GTS (2001 only), GTI (2002-04)	WR217
'02 on 4Tec GTX, GTX LTD, 07 Wake RTX GTX	WR221
RXP 215 (04-08)	WR223
Spark	WR244
GTI (06+), GTI SE	WR226
RXP-X (08-09), RXT-X (08-09)	WR229
RXT iS 225 & GTX Ltd iS 255 (09), GTX 155 (10), RXT 215, Wake Pro 215, GTX 215 iS, RXT 260 iS, GTX Ltd 260 iS, RXT-X 260 RS	WR235
RXP-X (2012+)	WR238
GTR 215 (2012+)	WR243



WR201 Yamaha

Yamaha	Part No.
SuperJet, Wave Blaster (All Pre-2008)	WR201
SuperJet (All Pre 08)	WR205
SuperJet (All Pre 08)	WR205D
GP 760/800, Raid 701/760, Vent 701 (All)	WR213
GP/XL 1200, Vent 760/1100, Raider 1100, Wave Blaster 800 (All)	WR214
XL LTD 1200 (All), XLT (2001)	WR216
GPR 800/1200 (2000+), GPR 1300 (2003+)	WR218
FX140 (All), FX HO, FX 160 (Pre 2008)	WR224
SuperJet (2008+)	WR228
FX SHO (2008-11)	WR232
FZR, FZS (2009-13)	WR233
FX SHO (2012-14)	WR237
VX Series	WR239
VXR/VXS (2009-14) *Does not fit 2015	WR240
FZR/FZS S2 (2014)	WR241

Polaris	Part No.
All Models Including MSX110/140/150 Except Hurricane/Genesis	WR210
Octane	WR220

Rickter	Part No.
All Models Except RICKTER Competition Models	WR242

Honda	Part No.
R-12X	WR230
F-15X	WR234

WORX RACING INTAKE GRATES

Kawasaki	Part No.
650 SX/X2 (All), Jet Mate	WR202
750 SX/SXI (All)	WR203
750 SXI Pro (All)	WR203D
440/550/550SX (All)	WR204
ZXI (All), STX 1100 (1988-99), STX 900 (1999)	WR209
Ultra 130, 150, DI (All)	WR215
STX 1200, STX-R (2000+), STX 12F (2003+), STX 15F (2004+)	WR219
SX-R 800 (2003-12)	WR222
SX-R 800 (2003-12) (Dominator Grate)	WR225
Ultra 250X, 260X, Ultra LX (2007+)	WR227
Ultra 300/310	WR236

Jet Dynamics

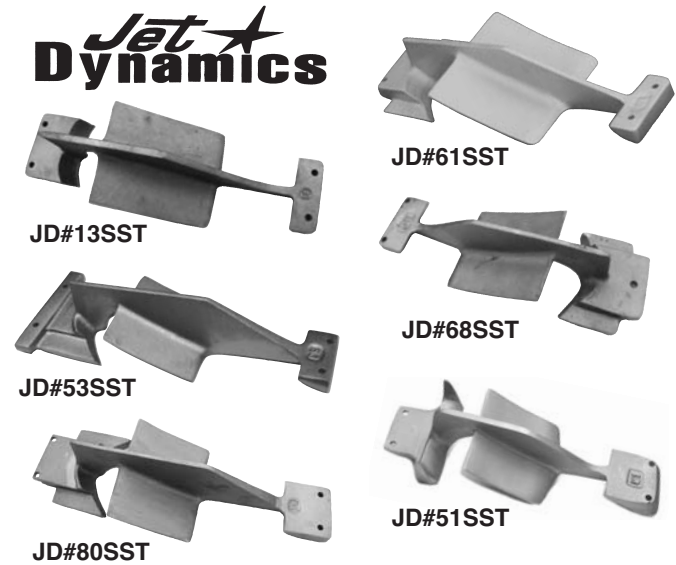

JET DYNAMICS SHAFT SHIELDING TOP LOADER (SST)

Yamaha	Part No.
Super Jet 650/701 Deep	JD#60SST
Super Jet 650/701 Deep 2" Longer, 1" Wider Blade (Created for KDX), Hurricane, Backie Chan	JD#60SST+2
Super Jet 650/701 Deep 1" Longer, 1" Wider Blade	JD#60SST+1
Super Jet 650/701 Standard Length 1" Wider Blade	JD#61SST
Wave Blaster/WB II	JD#13SST
FX-1	JD#68SST

Kawasaki	Part No.
440-550	JD#3SST
650 SX, 650 X-2 (Deep)	JD#1SST
650 TS, SC	JD#5SST
800 SXR Regular	JD#52SST
800 SXR Deep	JD#53SST
Ultra 150	JD#51SST
STX-R, 15F	JD#20SST
Trinity	JD#53SST+2-1/2

Hydrospace	Part No.
S-4 Hydrospace	JD#80SST

SOLAS INTAKE GRATES

SEA-DOO

Engine cc	Model	Year	INTAKE GRATE
1494	RXP(215HP)	2004~	 SS0205
	RXT	2005~	 SS0206
	GTX	2004~	
	GTX DI	2002~03	
951	RXX	2001-2002	 XP-IG-B
	XP/XP DI	2000-2004	
	XP Ltd.	98-99	
	RX / RX DI	2000-2003	
782	XP	97-98	
720	GTI/GTI LE/GTI RFI	2001-2005	 GSX-IG-B
	GTS	2001-2002	
951	GTX Ltd.	98-99	 GTX-IG-B
	GTX/GTX DI	2000-2001	
	GSX Ltd.	98-99	
	LRV / LRV DI	99-2003	
782	GSX RFI	99-2000	 GTX-IG-B
	GTX RFI	99-2002	
	GTX PRO	98	
720	GSX	96-98	 GTX-IG-B
	GS	98-2001	
782	GTI	98-2000	 SD-IG-B
	XP	95-96	
	SPX	97-98	
	XP	95	
	SPX	96	
	SPX	97	
	GS	97	
	GSI	97-98	
	GTI	96-97	
	GTS	97-2000	
	HX	95~	
	XP	93-94	
	SPX	94-95	
	GSX	94-95	
GTX	94-95		
650	XP	91-92	 SD-IG-B
	SPX	93	
	SPI	93-96	
	SP	88-96	
	GSX	92-93	
	GTX	92-93	
	GTS	92-96	
	GT	90-91	

HONDA



Engine cc	Model	Year	INTAKE GRATE
1235 Turbo	F-12X	2002~2007	 HW1-IG-B
1235	F-12	2002~2007	



YAMAHA

Engine cc	Model	Year	INTAKE GRATE
1052	FX High Output	2004~07	 SY0303
	FX CRUISER High Output	2004~07	
701	Wave Blaster	93-97	 YB-IG-B
	Superjet	94~	

KAWASAKI

Engine cc	Model	Year	INTAKE GRATE
1176	ULTRA 150	99-2006	 KH-IG-B
1071	ULTRA 130 DI	2001-2006	
750	750 SX	92-96	 KE-IG-B
	750 SXI	95-96	
	750 XIR	94	

POLARIS

Engine cc	Model	Year	INTAKE GRATE
1165	Pro 1200	2000-2002	 PL-IG-B
	VIRAGE TX	2000-2002	
	VIRAGE TXI	2001-2002	
1050	SL 1050	97	
	SLX 1050	99	
	SLXH 1050	98	
900	SLTX	96-98	
900	SL900	96-97	
779	SLX Pro 785	96-2001	
777	SL 780	96-97	
	SLT 780	96-97	
777	VIRAGE I	2002-2004	
744	SL 750	94-95	
	SLT 750	94-95	
700	SL750	93	
	VIRAGE	2000-2004	
	SLH	98-2001	
	SL 700DLX	97	
	SL 700	96-97	
	Hurricane	96-97	

FOUR STROKE
INTAKE SYSTEMS
ENGINE/GASKETS
EXHAUST
DRIVE LINE HANDLING
ELECTRICAL
WATERLINE /BILGE
STEERING & CONTROLS
BODY
ACCESSORIES
SERVICE TOOLS /HARDWARE
CHEMICAL

FOUR STROKE
INTAKE SYSTEMS
ENGINE/GASKETS
EXHAUST
DRIVE LINE HANDLING
ELECTRICAL
WATERLINE /BILGE
STEERING & CONTROLS
BODY
ACCESSORIES
SERVICE TOOLS /HARDWARE
CHEMICAL

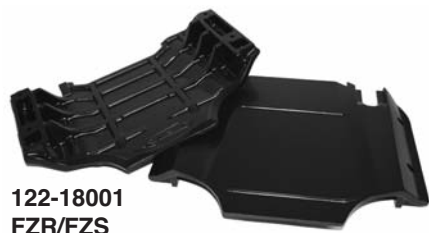

122-18001
FZR/FZS

R&D RIDE PLATE

Yamaha	Part No.
Super Jet 96-07	122-70102
Ruis Ride Plate	
Superjet (2008-13)	122-70108
GP 760/800/1200	122-12000
GP1200R/800R	122-12001
Speed Plate	
XLL 1200, XLT1200, XL800	122-12004
GPR 1200R/GPR1300R	122-13001
GPR 1300R Speed Plate	122-13000
FX 140 02-04	122-14000
05+ FX, FX140/ FXHO	122-16000
FX SHO (2008-11)	122-18000
SHO Cruiser	
FZR/FZS	122-18001
VXR/VXS	122-18004

Kawasaki	Part No.
750 SX/SXI 92-97	121-75101
Pro Series Plate	
750/900/1100ZXI	121-75500
Pro Series Plate	
750SXI Pro 98-02	121-75102
Pro Series Plate	
800 SXR 03-07 LTD	121-80000
Series Plate	
800SXR	121-80001
Pro Series Superstock Plate	
Ultra 250X	121-25000
Offshore Ride Plate	
Ultra 300X	121-30000



123-80910

Sea-Doo	Part No.
580/650 X-Tender (except 3 seater)	123-00000
Spark	123-80910



RIDE PLATE TRIM PADS FOR RXP-X 260

Description	Part No.
R&D Ride Plate*	123-80622
Trim Pads for RXP-X 260 (2012-13)	

*See page 31 for more information



122-13001

YAMAHA GP1200R/ GP1300R/GP800R RIDE PLATE TRIM PADS

The Ride Plate Trim Pad design will promote smoother and quicker planing under aggressive 0-30 mph acceleration, produce an overall more stable ride, and has proven to have better top speed averages!

Yamaha	Part No.
GPR 1200R/GPR1300R	122-13001
Ride Plate Trim Tab	



W2 RACING RIDEPLATE +70

You search for a ride plate with the most radical turning but is still extremely stable in rough water – even with your fastest SX-R800 – then the answer is the new W2 ride plate. No other plate on the market will let the SX-R800 turn so sharp and remain totally stable on fast straight and rough water. The V-End of this ride plate also makes a big improvement, it is like the fin of a fish, nature gives us the ideas.

This ride plate will change your SX-R to the most radical turning jetski and improve your lap times.

Kawasaki	Part No.
800 SXR Ride Plate	W2-RP

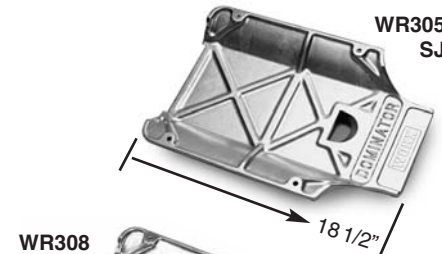

WR305
SJ

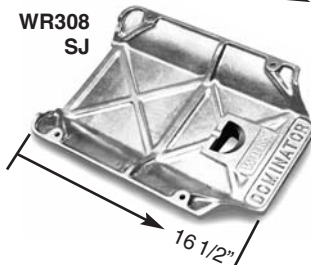

WR308
SJ

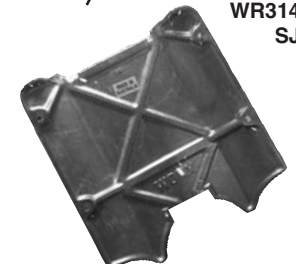

WR314
SJ

WORX RIDE PLATES

Yamaha	Part No.
Wave Blaster 1&2	WR301
SuperJet (1996-07) Long Race	WR305
Ride Plate	
SuperJet (1996-07) Recreation	WR308
Ride Plate	
SuperJet Rec (2008+)	WR312
FZR/FZS	WR313
SJ Freeride (2008+)	WR314
SJ Freeride (1996-2007)	WR315
FZR/FZS Rec	WR316

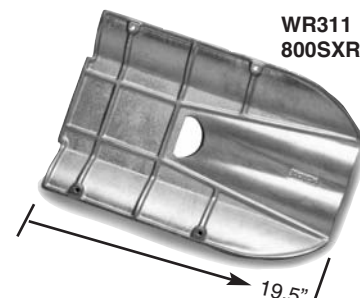

WR311
800SXR

Kawasaki	Part No.
750 SX/SXI (No "D" Cut out)	WR303
750 SXI-Pro	WR306
750 SX/SXI	WR307
SXR	WR310
SXR (Double Concave Ride Plate)	WR311

Polaris	Part No.
Octane	WR309

Sea-Doo	Part No.
Spark	WR319



RY21040
FX SHO

RY21011
SuperJet 2008+

RK21100

RIVA RACING RIDE PLATE

Yamaha	Part No.
RIVA FX-SHO (2008-11)	RY21040
RIVA FZR/FZS (2009-14)	RY21050
RIVA SuperJet (2008+) Pro Series Ride Plate	RY21011

Kawasaki	Part No.
RIVA Ultra 300X Performance Ride Plate	RK21100



RIVA TRIM TAB KIT

Description	Part No.
RIVA Sea-Doo Spark Trim Tab Kit	RS27130-FPT

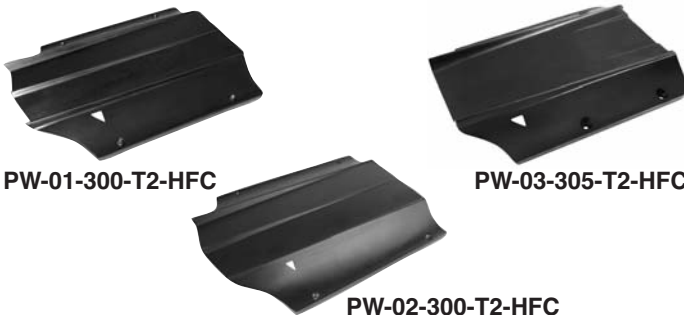

PW-01-300-T2-HFC

PW-03-305-T2-HFC

PW-02-300-T2-HFC

PRO WATERCRAFT RACE PLATE

*HFC (Hybrid Flex Composite)

Kawasaki	Part No.
800 SXR T2 Race Plate HFC - Standard	PW-01-300-T2-HFC

Hydrospace	Part No.
HSR S4 Race Plate HFC - Standard	PW-02-300-T2-HFC

Yamaha	Part No.
Superjet (2008+) Race Plate HFC - Standard	PW-03-305-T2-HFC



HOT PRODUCTS REPLACEMENT HULL INSERTS

Replacement for damaged or missing hull inserts that hold ride plates and intake grates in place.

Description	Part No.
Repair Kit (4 inserts per kit)	54-7900

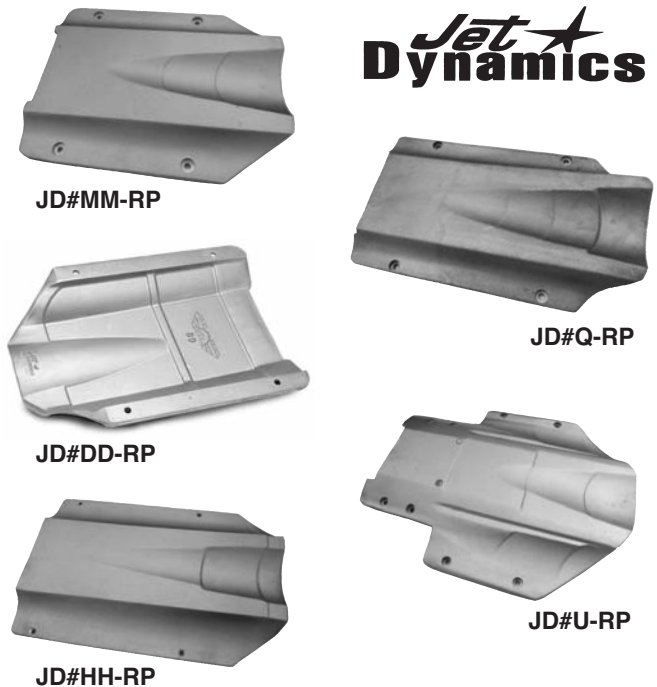

JD#MM-RP

JD#Q-RP

JD#DD-RP

JD#U-RP

JD#HH-RP

JET DYNAMICS CONCAVE RIDE PLATES

U.S. PATENT NO. 335.484

Yamaha	Part No.
Wave Blaster/WB II 100mm Longer	JD#MM-RP
FX-1	JD#Q-RP
Super Jet (1996-2007)	JD#D-RP
Rider weight up to 155Lbs	
Super Jet (1996-2007)	JD#DD-RP
Rider weight over 160Lbs (100mm longer)	
Super Jet (2008+)	JD#D-RP+08
Rider weight up to 155Lbs	
Super Jet (2008+)	JD#DD-RP+08
Rider weight over 160Lbs (100mm longer)	

Kawasaki	Part No.
440/550	JD#B-RP
650 SX	JD#A-RP
650 X-2	JD#C-RP
650-TS	JD#E-RP
ZXI	JD#Z-RP
750 SXI-Pro/800SXR short	JD#T-RP
750 SXI-Pro/800SXR - rider weight over 165Lbs	JD#TT-RP
Ultra 150	JD#U-RP
STXR-15F	JD#Z-RP

Hydrospace	Part No.
S4 Hydrospace	JD#HH-RP



TBM123-Y08
(SJ 2008+)

TBM123
800 SXR

TBM RIDE PLATES

Description	Part No.
Yamaha SuperJet "Signature Series" (2008+) Ride Plate	TBM123-Y08
Kawasaki SXR 800 "Signature Series" "Race" Ride Plate	TBM123
Kawasaki 300X Ultra Tunable Ride Plate	TBM123-UL3

FOUR STROKE
INTAKE SYSTEMS
ENGINE/GASKETS
EXHAUST
DRIVE LINE HANDLING
ELECTRICAL
WATERLINE /BILGE
STEERING & CONTROLS
BODY
ACCESSORIES
SERVICE TOOLS /HARDWARE
CHEMICAL

BLOWSION



BLOWSION TUBBIE SPONSONS

Description	FIT	Part No.
A. Blowision Tubbie 1	Universal Fit	02-01-002
Blowision Tubbie 2	Universal Fit	02-01-003
Blowision Tubbie MIII	Universal Fit	02-01-004



02-01-015



02-01-012

BLOWSION TUBBIE DESTROYER SPONSONS

New removable Tubbie Destroyer front sponsors from Blowision are composite front and back (not foam backed) and built specifically shaped to each model of standup. They are a 3 bolt ten minute a side install. No more time-consuming installs using permanent screws and glue like the Blowision Tubbie I, II, and III. Patent Pending

Destroyer Front Sponsons	Color	Part No.
Kawasaki SX-R, Hydrospace	White	02-01-010
Kawasaki SX-R, Hydrospace	Black	02-01-015
2008+ Yamaha Superjet	White	02-01-012
2008+ Yamaha Superjet	Black	02-01-016
1996-07 Yamaha Superjet	White	02-01-013
1996-07 Yamaha Superjet	Black	02-01-017
Rickter	White	02-01-008
Rickter	Black	02-01-009

STAND UP SKI REAR SPONSONS

WORX	Part No.
800 SXR Rear Sponson	WR528
Superjet Rear Sponson	WR544

Kommander	Part No.
800 SXR, SuperJet, Hydrospace Rear Sponson	KOM-201-SP*

Pro Watercraft	Part No.
Performance Rear Sponson	PW-SP-200-HFC*
Hybrid Flex Composite (HFC), Over Bumper	
Performance Rear Sponson	PW-SP-205-HFC*
Hybrid Flex Composite (HFC), Under Bumper	

TBM	Part No.
800 SXR Rear Sponson	TBM101

* These rear sponsons feature a recess in the sponson that creates a flush finished surface on the bond rail of the hull.



WAVE S.R.L. FRONT SPONSONS

Short version of Front Sponson is legal for Ski Stock, Ski Limited, Ski Superstock and Ski GP.

Long version of Front Sponson is legal for Ski Limited, Ski Superstock and Ski GP (No Ski Stock for 2013 IJSBA rules).

Kawasaki	Part No.
Wave S.R.L. Front Sponsons Black	FFS101
Short Version - 90cm Length	
Wave S.R.L. Front Sponsons Black	FFS-L
Long Version - 126.5cm Length	



PROWATERCRAFT RACING PERFORMANCE SPONSON KIT

ProWatercraft HFC front sponsons bring functionality with cost effectiveness. These performance sponsons offer improved turning grip, better stability in a straight line and very important improved stability when leaning over in a turn. These HFC sponsons are tough and durable and come with a flat black finish. The kit includes 8 stainless steel screws for each side and a tube of silicone to attach it.

Description	Part No.
ProWatercraft Racing Performance Sponson Kit - Black	PW-SP-250-HFC

* HFC is Hybrid Flex Composite



PW-SP-200-HFC



PW-SP-205-HFC



KOM-201-SP

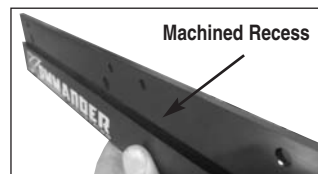

Machined Recess



WR528 WR544



TBM101

WORX RACING COMPONENTS



WORX RACING SPONSONS

Fitting WORX sponsons to your PWC is like fitting extra wide tires to your road car. Unbelievable cornering, better control in the rough and predictable inline tracking while towing wakeboards or waterskiers. WORX sponsons are easy to fit, look great and bolt right into stock mounting holes.

	Part No.
Sea-Doo	
SP, SPI, XP (1992-96), SPX (1996-97)	WR504
GS, GSI, GSX, GSX LTD, GSX RFI (All)	WR505
HX (All)	WR506
SP, SPI, XP (1992-96), SPX (1996-97)	WR510
XP, XP LTD, XP DI (1997+)	WR515
GTX, GTX LTD, GTX RFI (1997-01), GTI (1996-01)	WR517
GTX (1993-95), GTS (1996-01)	WR518
RX, RXX, RX DI (ALL)	WR521
GTX (2002-04), RXP (2004)	WR526
GTX, RXP, RXT, RXT-X, RXP-X (2005+), GTI (2006+)	WR534
RXP-X, RXT-X, All RS Models (2008)	WR540
Professional Race Sponsons	
iS Models (2009)	WR545
RXP-X	WR548
GTR 2012+	WR553
Spark	WR555
Kawasaki	Part No.
ZXI (All)	WR508
STX 1100 (1988-99), STX 900 (1999)	WR513
Ultra 130, 150, DI (All)	WR519
STX-R 1200 (All)	WR525
STX 900/1100 DI (2000+), STX 12F, STX 15F (All)	WR527
SX-R 800 (2003+) Rear Sponsons	WR528
Ultra 250X/260X/Ultra LX (2007+)	WR536
Ultra 300 LX	WR547
Yamaha	Part No.
WaveRaider	WR507
GP 760/800/1200 (All)	WR511
Wave Venture, XL 1200 (1996)	WR514
XL 1200/1200 LTD (1999-00), XL 800 (2000-01)	WR520
GPR 800/1200 (2000-05), GPR 1300 (2003-04)	WR522
XLT (All)	WR524
FX 140, FX HO	WR529
GRP (2005+)	WR533
FX SHO (2008)	WR542
FZR, FZS (2009-12)	WR543
SuperJet Rear Sponsons (All models)	WR544
FX, FXSHO (2012+) NEW 2 Position Backing Plate	WR551
VXR, VXS	WR552
FZR, FZS (2013)	WR554
FZR, FZS (2014)	WR556
Honda	Part No.
R-12, R-12X	WR530
F-12, F-12X, F-12 GPScape	WR531
R-15X (2009)	WR541
Polaris	Part No.
SLX 785 Pro (All)	WR516
Virage/Freedom, TX, SL, SLT, SLXH (All)	WR509
Hydrospace	Part No.
S4	WR546



R&D G-FORCE SPONSONS

R&D designed and tested to deliver superior cornering, unmatched speed, and improved straight line stability. R&D Pro Series Sponson Kits main feature includes an ultra strong cast aluminum CNC machined backing plate, which is far superior over plastic backing plates with furniture inserts for threads! The R&D Pro Series Sponson Kits offer a adjustability, smoother more predictable ride with much better low and high speed turning capabilities!



2-position back plate (forward or backward) and 3-position (depth) sponson blade adjustability.

Sea-Doo	Part No.
GTX (03-04), RXP	123-95100
RXP-X, RXT-X, GTX (05+), GTI (06), RXT (05+)	123-95101
RXP (05+)	
RXT iS/aS	123-95110
RXP-X 260(12-13)	123-95111
Spark	123-96002



Yamaha	Part No.
FX SHO, FX SHO Cruiser	122-01800
FZR/FZS (2009-13)	122-01801
FZR/FZS (2014)	122-01804
VXR/VXS	122-01820
FX HO 2012/FX SHO 2012/ FX Cruiser HO 2012, FX SVHO 2014	122-01799



Kawasaki	Part No.
Ultra 250/260/300/310	121-25001



Yamaha	Part No.
TBM Racing FZR/SHO/FX/VX Adjustable Sponsons	TBM101-YAM
Kawasaki	Part No.
TBM Ultra 250/260/300/310 Adjustable Sponsons*	TBM101-UL
TBM 800 SXR Rear Sponsons	TBM101

FOUR
STROKE

INTAKE
SYSTEMS

ENGINE/
GASKETS

EXHAUST

DRIVE LINE
HANDLING

ELECTRICAL

WATERLINE
/BLIGE

STEERING
& CONTROLS

BODY

ACCESSORIES

SERVICE TOOLS
/HARDWARE

CHEMICAL

RIVA RACING SPONSONS



Sea-Doo	Part No.
RXP, RXP-X, RXT, RXT-X, GTX (08-11)	RS26050
RXP-X 260/300 (T3),	RS26110
RXT-X 260/300/RXT-X aS 260 (S3)	
Spark	RS26130

RIVA YAMAHA FX-SHO, FZR/FZS/VX SPONSON KIT



Unique blade design provides a significant improvement to the handling characteristics. Reduces rough water hunting and rolling

sometimes experienced with stock sponsons. Sponson depth is adjustable to control the amount of influence they have on craft. Easily installs to stock mounting points with our bulletproof mounting system that features billet inserts in sponson fins. Fits all Yamaha FX-SHO, FZR, FZS & VX models.

Description	Part No.
FX-SHO (08-11), VXR/VXS (11-14)	RY2625
FX-SHO/FZR/FZS/VX	
FZ (2014-16), FX-SHO (2012+)	RY26070

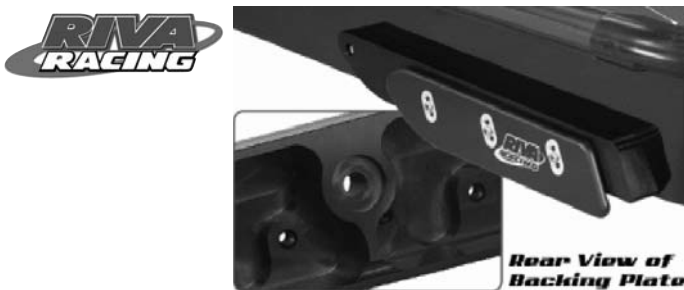

Kawasaki	Part No.
Ultra 250/260/300/310 Pro Series	RK26090



Drilling Required



STIX BEACH HOUSE SPONSONS

Designed by racers and made for racing. Installation does not use the OEM mounting holes if applicable and requires drilling of new mounting holes.

Yamaha	Part No.
GP760/800/1200 97-00	SX202-W (White)
Pro Slalom Series With Short Face Plates*	SX202-B (Black)
These sponsons perform the best in smooth water conditions	



NEW



SE-101035SW



SE-101037SP

SE "SPEED MAGIC" SPONSON

Kawasaki 250/260/300/310	Part No.
Standard Back Plate - Silver Outside Plate	SE-101035
Standard Back Plate - Green Outside Plate	SE-101035G
Wide Back Plate - Silver Outside Plate	SE-101035SW

Yamaha FX-SHO (2012+), FX HO (2012), FX Cruiser HO (2012) & FX SVHO (2014)	Part No.
Speed Magic Sponsons - Silver	SE-101037SP
Speed Magic Sponsons - Gold	SE-101037GP

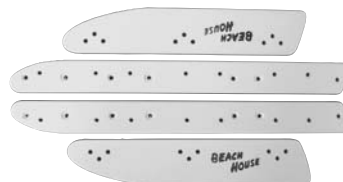

BH306-W



Sea-Doo	Color	Part No.
RX, RX DI, RXX	Black	BH106-B

Kawasaki	Color	Part No.
STX750 97-98, XI 95-99, XIR 94-95, STS 96-97	White	BH301-W

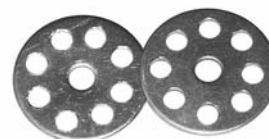

BEACH HOUSE LARGE WASHER

* Sold Each. Thickness 1.5 mm

Description	Part No.
Stainless Steel Large Washer (Sold individually)	NO1

KAWASAKI DRIVE COUPLERS

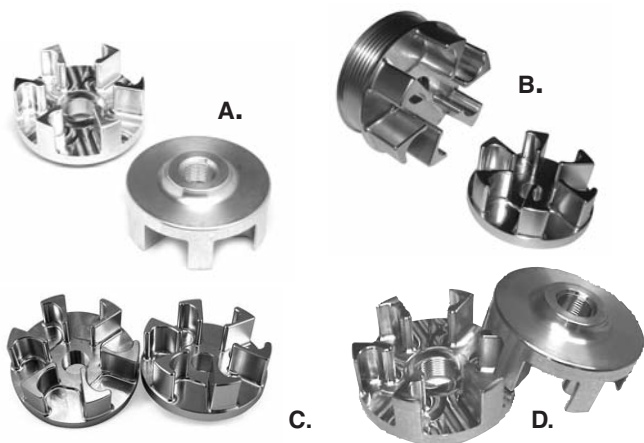

ADA BILLET DRIVE COUPLER SET

Kawasaki	Thread	Part No.
A. 750SS 94-97, XI 93-97, 750ZXI 95-97, SXI 95-97, 800SXR	20mm	KA800DCS
B. Ultra 250X/260X		31-700590
C. STXR/Ultra 150/STX/12F/15F	24-1.5mm	31-700490
D. 650 All, 750 (92-93)	18mm	31-700190

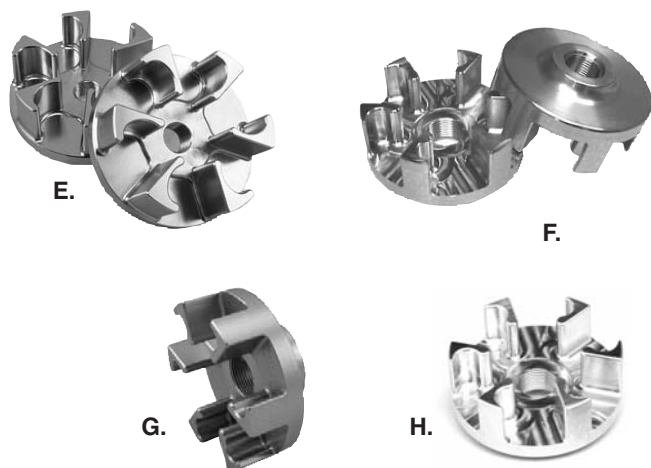

ADA BILLET SPECIAL COUPLER

Kawasaki	Thread	Part No.
E. 800 SXR Heavy Duty Coupler Set Must use larger 4.34" rubber damper (Part #003-209)	20mm	31-700690
F. 650/750 Coupler Set 1 • 18mm threaded coupler & 1 • 20mm threaded coupler	18/20mm	31-700290
G. K1100 Conversion For K1100 crankshaft (<i>One piece only</i>)	24-1.5mm	31-700390
H. 750SS 94-97, XI 93-97, 750ZXI 95-97, SXI 95-97, 800SXR Driveshaft Side (<i>One piece only</i>)	20mm	KA800DC



WSM REPLACEMENT COUPLERS

WSM couplers sold individually.

Kawasaki	Thread	O.D.	Part No.
440 77-92, 550 82-89	17mm	85mm	003-211
550SX 90-95, 650 All, 750 92-93	18mm	85mm	003-210
750 94+, 800SXR	20mm	85mm	003-212
900STX 97-98, ZXI 95-97	24mm	85mm	003-213
900/1100/1200	24mm	100mm	003-214
12F, 15F, Ultra150, Ultra250/260	23mm	109mm	003-225



WSM REPLACEMENT DRIVE COUPLER RUBBER DAMPER

Kawasaki	Part No.
Kawasaki 440/550/650/750/800/900STX/900ZXI	003-201
Kawasaki 900/1100/1200 (Use with 003-214)	003-208
Kawasaki Ultra 150/250/260/12F/15F (OEM# 9160-3711)	003-209



DRIVE COUPLER REMOVAL TOOLS

Kawasaki	Part No.
Drive Coupler Removal Tool	DC-800
Kawasaki 440/550/650/750/800 & Polaris Octane Coupler Puller 12F/15F/Ultra 150/250/260	003-310

KAWASAKI DRIVESHAFT PARTS



003-405-01



003-405

WSM DRIVE SHAFT BEARING HOUSING

Kawasaki	Part No.
Driveshaft Bearing Housing only for	003-405
550SX 91-95, All 650/750/800/900/1100 Runabout Models	
OEM# 13280-3730	
Complete Assembly with Bearing for	003-405-01
550SX 91-95, All 650/750/800/900/1100 Runabout Models	



TBM RACING BEARING HOUSING SUPPORT

TBM Racing's Kawasaki driveline bearing housing support is an absolute must have for any high horsepower Kawasaki Jet Ski. The TBM driveline bearing housing support is 50% lighter. They build to ensure the bearing housing doesn't self destruct from the increased stress and rpm of a modified craft. Fits 550SX, JS650, 750 and 800 stand-ups and every year and model Kawasaki runabout.

Description	Part No.
TBM Racing Kawasaki Driveline Bearing Housing Support	TBM141



RHAAS KAWASAKI BEARING HOUSING

Direct replacement for OEM housing. Made from anodized aluminum. Comes pre-assembled with bearing and seals.

Description	Part No.
Kawasaki Bearing Housing	KAWIBEARING
Complete Assembly with Bearing and Seals	



All Kawasaki JS440 & JS550 (-90)

Kawasaki	Description	Part No.
440 (77-92)	Driveshaft Seal & Bearings Repair Kit	54-3003
550 (82-89)		



550SX, 650SX, 750SX, 800SXR, 900ZXI, 1100ZXI

Kawasaki	Description	Part No.
550SX 1990-95	Driveshaft Seal & Bearings	54-3027
All 650/750/800/900/1100 Runabout Models	Repair Kit	



WSM KAWASAKI TRIM/PUMP SEAL

Kawasaki	OEM#	Part No.
Trim/Pump Seal	39145-3732	003-550
for Kawasaki 650/750/800 All		

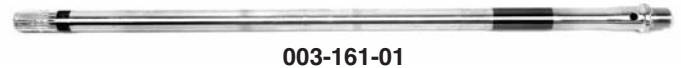

003-161-01



003-161-02

WSM REPLACEMENT DRIVE SHAFTS FOR KAWASAKI PWC

Kawasaki	Year	OEM#	Length	Part No.
750 SS	94-97	39159-3717	23-11/16"	003-161-01
750 STX	98	39159-3717	23-11/16"	003-161-01
750 ST	94-95	39159-3717	23-11/16"	003-161-01
750 STS	95-97	39159-3717	23-11/16"	003-161-01
750 SXXI	93-97	39159-3717	23-11/16"	003-161-01
750 XI Sport	98-99	39159-3717	23-11/16"	003-161-01
750 SX	92-95	35159-3714	24-7/16"	003-161
750 SXI	95	35159-3714	24-7/16"	003-161
900 STS	01-03	39159-3732	23-1/8"	003-161-02
900 STX	97-06	39159-3732	23-1/8"	003-161-02
1100 STX	97-99	39159-3732	23-1/8"	003-161-02
1100 STX DI	00-03	39159-3732	23-1/8"	003-161-02
1200 STXR	02-05	39159-3732	23-1/8"	003-161-02
1100 ZXI	96-03	39159-3724	20-1/2"	003-161-04
		39159-3740		
Ultra 150	99-05	39159-3730	21-3/4"	003-161-03
Ultra 250X	07-08	39159-3742	22-1/8"	003-161-06
Ultra 260LX/260X	09-10	39159-3742	22-1/8"	003-161-06

KAWASAKI JET PUMP PARTS

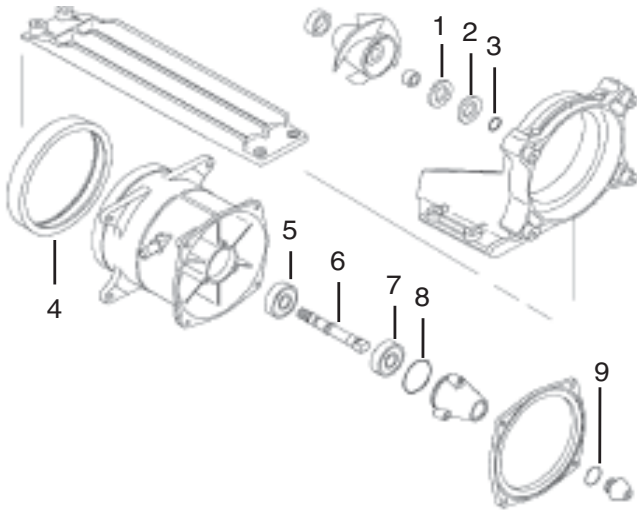

003-107



003-109



003-114



003-109-02



003-109-03

WSM KAWASAKI REPLACEMENT PUMPSHAFT

Kawasaki	OEM No.	Part No.
650/750 (Except ZXI), 800 SXR	13107-3721	003-107
750/900/1100 ZXI	13107-3737	003-109
12F/15F/900STX/STXR/1200 STXD1		
Ultra 130 (01-04)	13107-373	003-114
Ultra 150 (99-05)		
Ultra 250 (07-08)	13107-3788	003-109-02
Ultra 260X & LX (2009)	13107-3809	
Ultra LX (07-11)		
Ultra LX 3 Pass (09-10)		
Ultra 300 LX (11-13)	13107-0728	003-109-03
Ultra 300 X (11-13)	13107-0764	
Ultra LX (12-13)		

KAWASAKI JET PUMP REPAIR/REPLACEMENT PARTS

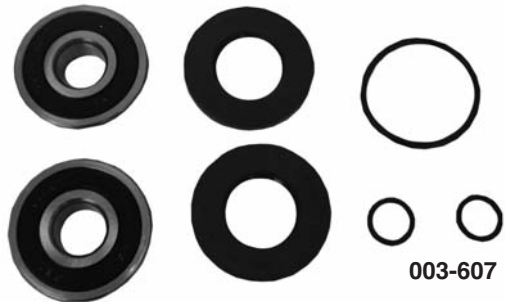

WSM KAWASAKI JET PUMP REPAIR KITS

Most Kits Include: Oil Seals • O-Rings • Bearings

Kawasaki	Part No.
550 (1982-89)	003-601
550 (1990-95)	003-602
650 All, 750 All, 800 All	003-607
750 ZXI (95-97), 900 STS (01-02), 900 ZXI (95-97)	003-608
900 STX (01-03), 1100 STX (97-99), 1100 STX DI (00-03), 1100 ZXI (96-03)	003-609
1200 STX-R (02-04), STX-12F (03-04), STX 15F (04)	
Ultra 130 (01-04), Ultra 150 (99-02)	003-606
Ultra 150 (03-05)	003-613
1200 STX-R (05), STX 12F (05-07), STX 15F (05-10), Ultra LX (07-10), Ultra 250 X (07-08)	003-614
STX 15F (11-13), Ultra LX (11-13), Ultra 260 X (09-10), Ultra 300 (11-13)	003-614-01

PWCoffshore.com to sponsor the 2016 Best Pit Crew Trophy Awards at the 12th Annual IJSBA Hot Products Mark Hahn Memorial Havasu 300 Race.



PWCoffshore.com's Mark Gerner will award 1st and 2nd place "Best Pit Crew" trophies for pit crews participating in the 2016 IJSBA Hot Products Mark Hahn Memorial Havasu 300 Mile PWC Race in Lake Havasu City, Arizona.

The IJSBA Hot Products Mark Hahn Memorial Havasu 300 Mile PWC Race is a test of pilot, technicians, craft and PWC pit crew. Pit crews are challenged to recover, fuel and launch PWCs in less than a minute, this is no easy task. This process requires planning, process evaluation and improvement, practice and perfect execution on race day.

Mark Gerner says, "We are happy to sponsor the Best Pit Crew Award, the pit crews work exceptionally hard prior to, and on, race day and deserve all of the recognition they receive. Many of the fuelers train year-round to have the necessary strength to throw around 80 pounds of fuel."

Mike Follmer adds, "Pit crews are a big part of winning this event, getting their rider in and out, and not spilling any fuel can make or break a team's success in this event."

Pit crews make it all happen at this event, we are glad to recognize their efforts. Race officials will make the top two pit crew selection based on their observations of the crews throughout the race. This is the 12th annual IJSBA Hot Products Mark Hahn Memorial Havasu 300, presented by Yamaha.



FOUR STROKE
INTAKE SYSTEMS
ENGINE/GASKETS
EXHAUST
DRIVE LINE HANDLING
ELECTRICAL
WATERLINE /BLIGE
STEERING & CONTROLS
BODY
ACCESSORIES
SERVICE TOOLS /HARDWARE
CHEMICAL

SEA-DOO COUPLERS & DRIVE SHAFT PARTS

FOUR STROKE
INTAKE SYSTEMS
ENGINE/GASKETS
EXHAUST
DRIVE LINE HANDLING
ELECTRICAL
WATERLINE /BILGE
STEERING & CONTROLS
BODY
ACCESSORIES
SERVICE TOOLS /HARDWARE
CHEMICAL



003-239



003-239-01

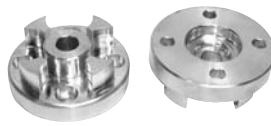

003-239-02



003-240



003-240-03

WSM REPLACEMENT COUPLERS

WSM couplers sold individually.

Sea-Doo	OEM#	Part No.
720HX 95-97, 800XP 97	272-000-046	003-239
800XP 97 PTO Coupler	290-958-096	003-239-01
951XP LTD 98	290-958-130	003-239-02
951XP 001-01	290-958-137	003-239-03
800RFI 05, 951 99-07	272-000-158	003-240
XP 99-05	272-000-158	003-240-03



003-202



003-203

WSM REPLACEMENT DAMPERS

Sea-Doo	OEM#	Part No.
HX 95-99	293-830-026	003-202
XP 00-02/XP DI 03-04	293-830-067	003-203



SEA-DOO COUPLER RETAINER

Hot Products precision machined thermal fit coupler retainer, holds coupler in casing and prevents shaft damage.

Sea-Doo	Coupler	Part No.
HX 96+	Front	54-1152
XP 97	Front/Rear	54-1152



011-111



011-112

THRU HULL REPAIR FITTING FOR SEA-DOO IMPELLER SHAFT

Sea-Doo	Part No.
All Models OEM Standard Size	011-111
OEM# 292-000-075	
All Models Oversize	011-112



003-125-02



003-127-01



003-129

WSM LIGHTWEIGHT STYLE PTO ENDS

Sea-Doo	Part No.
580/650/720	003-125-02
800	003-127-01
951	003-129



003-126

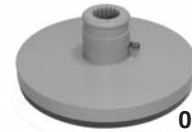

003-127

WSM OEM REPLACEMENT PTO ENDS

Sea-Doo	OEM#	Part No.
650 (93-95), 720 (95-05)	290958011, 290958012	003-126
800 (96-05), 800 GSX (96-7)	290958056, 420958057	003-127



PTO BOOT

Sea-Doo	Part No.
All Models OEM#272-000-001	003-100



DRIVE SHAFT BOOT

Sea-Doo	OEM#	Part No.
720HX (1995), All Models (96-97)	272-000-041	003-104-01
580/650 (All to 95)		003-102
GTX 4-Tec, RTX (05)	272-000-183	003-104
GTI/GTX (02-05), RX (02-03)	272-000-184	003-104-01
RTX (06-13), RXT-X		003-101-01
RXP, RXP-X, GTR, GTX 06-13		



003-350



003-351

DRIVE SHAFT BUMPERS

Sea-Doo	OEM#	Part No.
560/650/720 All (sold in pairs)	292-000-019	003-350
GTI 130, 155, LTD, SE (2006-12), GTR 215 (2012), TS 130 (2011-12), GTX (2002-12), XP-X (2004-12), Wake 155/215/255 (2009-12)	272-000-173	003-351

SEA-DOO DRIVE SHAFT PARTS



003-115



003-116



003-115-01



003-116-01

SEAL CARRIER

Sea-Doo	OEM Number	Housing Only	Complete Assembly
GSX (98), GT (90-91), GTS/GTX (92-95), SP (90-95), SPi (93-95), XP (92-94), XPi (94), XP800 (95)	272-000-024	003-115	003-115-01
HX (95-97), XP (97), XP Ltd (98), XP (02), XP Di (03-04), 3D Rfi (05), 3D 947, Di (06)	272-000-012-400	003-116	003-116-01



009-730-01



54-3135

SEAL CARRIER, OIL SEAL & BEARING

Sea-Doo	Part No.
Seal Carrier Bearing	54-3135
Seal Carrier Oil Seal	009-730-01



SEA-DOO SEAL CARRIER REPAIR KIT

Sea-Doo	Part No.
HX (95-97), XP (97+)	003-120



003-118



003-118-01



003-118-02

SUPPORT RING

Sea-Doo	OEM#	Part No.
HX 95-97, XP 97-Up	272-000-064	003-118
GTI 06, GTX 4 TEC 02-07, RXT 05	272-000-176	003-118-01
GTX 06-07, RXP 04-07	271-001-434	003-118-02



003-110K



003-110-02K

WSM DRIVE SHAFT REPAIR KIT

Sea-Doo	Part No.
GS (96-01), GTI (98-05), GTI LE (02-04), GTS (98-01), 3DRFI (05), GSX RFI (99-00), GTI LR RFI (03-05), GTI RFI (04-05), GTX RFI (98-02), SPX (98-99), XP (97), 3D DI (06-07), GSX LTD (97-99), GTC (00-02), GTX DI (00-03), GTX LTD (98-99), LRV (00-01), LRV DI (02), RX (00-02), RX DI (00-03), RXX (01), XP (00-01) XP DI (03-04), XP LTD (96)	003-110K
GTI (06-07), GTI 130 (08-13), GTI 155 (08-13)	003-110-01K
GTS 130 (11-13), GTX (02-07), GTX 155 (08-09) RPX NA (07), RXT (05), WAKE 155 (08-13), WAKE 215 (08)	003-110-02K
GTR 215 (12-13), GTX 155 (10-13), GTX 215 (08-13), GTX 255 (06-09), GTX LTD (06-07), GTX LTD 255 (09), RXP 215 (06-09), RXP 255 (09-11), RXP 260 (12-13), RXT (06-07), RXT 215 (08-10), RXT 255 (08-09), RXP 260 (10-13), WAKE PRO 215 (09-13)	



003-110



003-110-01



003-110-02

CARBONE RING

Sea-Doo	Part No.
720 HX 95, All Models 96-97 OEM#272-000-042, 272-000-770	003-110
GTI, GTS 2006-08 OEM#272-000-177	003-110-01
RXP/RXT 215/255/260 OEM#271-001-420	003-110-02

FOUR STROKE
INTAKE SYSTEMS
ENGINE/GASKETS
EXHAUST
DRIVE LINE HANDLING
ELECTRICAL
WATERLINE /BILGE
STEERING & CONTROLS
BODY
ACCESSORIES SERVICE TOOLS
HARDWARE
CHEMICAL

SEA-DOO DRIVE SHAFTS

WSM REPLACEMENT DRIVE SHAFT



FOUR STROKE
INTAKE SYSTEMS
ENGINE/GASKETS
EXHAUST
DRIVE LINE HANDLING
ELECTRICAL
WATERLINE /BILGE
STEERING & CONTROLS
BODY
SERVICE TOOLS ACCESSORIES
SERVICE TOOLS ACCESSORIES /HARDWARE
CHEMICAL

MODEL	CC	YEAR	OEM#	Length	Part No.
GT	580	1990-91	272-000-065	17"	003-150
GTS	580	1992-94	272-000-020		
GTX	580	1992-94			
SP	580	1989-94			
SPI	580	1993-94			
SPX	580	1993-94			
XP	580	1991-94			
XPI	650	1994			
GTS	580	1995	272-000-055	17"	003-153
SP	580	1995			
SPI	580	1995			
GTX	650	1995			
SPX	650	1995			
GTS	580	1996	272-000-073	17"	003-154
SP	580	1996			
SPI	580	1996			
GTI	720	1996-97			
GTS	720	1997-2000			
SP	720	1997			
SPX	720	1996-97			
HX	720	1995-97	272-000-009	20-1/2"	003-163
HX	720	1995	272-000-001	22-3/4"	003-143
HX	720	1996	271-001-556	20-1/4"	003-145
GS	720	1997-2001	272-000-096	18"	003-152
GTI	720	2001-05			
GTI LE	720	2002-04			
GTS	720	2001			
SP	720	1997			
SPX	720	1997			
GSI	800	1997			
GSX	800	1996-97			
GSX RFI	800	1999-2000			
GTI LE RFI	800	2003-05			
GTI RFI	800	2004-05			
GTI RFI STD	800	2005			
SPX	800	1998-99			
GTI	720	1997	272-000-127	21"	003-164
GTI	720	1999-2000			
GTS	720	1997			
GTX	800	1997			
GTX RFI	800	1998-2002			
GTX	800	1996	272-000-077	21"	003-166
XP	800	1995	272-000-062	19-7/8"	003-151
XP	800	1997	272-000-107	23-3/8"	003-144



MODEL	CC	YEAR	OEM#	Length	Part No.
3D RFI	800	2005	272-000-150	20-7/16"	003-169
XP	951	2000			
XP DI	951	2003-04			
XP LTD	951	1999			
GSX	951	1997-99	272-000-151	17-3/4"	003-159
RX	951	2000-02			
RX DI	951	2000-03			
GTX	951	2000-02	272-000-160	20-5/8"	003-168
GTX DI	951	2000-03			
GTX LIMITED	951	1998-99			
LRV	951	2000-01			
ALL GTX 4-TEC	1503	2002-04	272-000-186	23"	003-156
			271-001-449		
ALL GTI	1503	2006-08	271-001-534	23-1/4"	003-157
ALL GTX	1503	2006-08			
WAKE 155	1503	2008			
WAKE 215	1503	2008			
RXP	1503	2004-07	271-001-432	23-3/4"	003-158
RXP 215	1503	2008-12	271-001-601		
RXP X 255	1503	2008-12			
GTX 215	1503	2008	271-001-550	23-1/4"	003-158-01
GTX 4-TEC LTD	1503	2006			
GTX LTD 215	1503	2008			
GTX LTD BVIC	1503	2007			
GTX WAKE BVIC	1503	2007			
RXT	1503	2006			
GTI 130/155	1503	2009-11	271-001-623	23-1/4"	003-156-03
GTI LTD 155	1503	2011-13	271-001-724		
GTS 130 PRO	1503	2011			
GTX 155	1503	2009			
WAKE 155	1503	2009-11			
GTX 155	1503	2010-12	271-001-719	23-3/8"	003-158-03
GTX 215	1503	2009-10	271-001-636		
GTX 260	1503	2010			
GTX LTD 255	1503	2009			
RXP X 255	1503	2009-10			
RXT 215	1503	2009-10			
RXT 255	1503	2009			
RXT 260	1503	2010			

SEA-DOO JET PUMP ASSEMBLIES



003-700

Includes bearings, oil seal and wear ring



003-710



003-720



003-721

INCLUDES WEAR RINGS ONLY



003-700K



003-710K

WSM SEA-DOO JET PUMP ASSEMBLIES

Sea-Doo Jet Pump Assembly	Part No.
580 (89-96), 650 (93-95), 720 (95-98), 800 Carb Models (95-98), GSX RFI (99-00), GTX RFI (99-02) 140mm	003-700
720GTI (02-05), 720GTI LE (02-04), GTI800 RFI (04-05), GSX/GSX LTD 951 (99), GTX DI 951 (03), LRV DI 951 (02), RX DI 951 (02), XP DI 951 (03-04) 155.5mm	003-710

Sea-Doo Complete Jet Pump Kits	Part No.
580 (89-96), 650 (93-95), 720 (95-98), 800 Carb Models (95-98), GSX RFI (99-00), GTX RFI (99-02) 140mm	003-700K
720GTI (02-05), 720GTI LE (02-04), GTI800 RFI (04-05), GSX/GSX LTD 951 (99), GTX DI 951 (03), LRV DI 951 (02), RX DI 951 (02), XP DI 951 (03-04) 155.5mm	003-710K

Sea-Doo	Part No.
2004-2012 All 4-Tecs 130/155 HP Takes 003-502 Wear Ring 155.5mm	003-720
2004-2013 All 4-Tecs 215/255/260 HP Takes 003-499 Wear Ring 159.8mm	003-721



003-722K

WSM SEA-DOO 4-TEC COMPLETE HOUSING ASSEMBLIES

Sea-Doo	Part No.
2004-2008 All 4-Tecs 130/155 HP 155.5mm Pump/22mm Drive Shaft - For use with Solas SR Props & 003-502 Wear Ring	003-720K
2004-2008 All 4-Tecs 215/255 HP 159mm Pump/27mm Drive Shaft - For use with Solas SRX Props & 003-499 Wear Ring	003-721K
2009-2012 All 4-Tecs 130/155 HP 155.5mm Pump/22mm Drive Shaft - For use with 003-502 Wear Ring	003-722K
2009-2013 All 4-Tecs 215/255/260 HP 159mm Pump/27mm Drive Shaft - For use with Solas SRZ Props & 003-499 Wear Ring	003-723K



003-700-01



003-710-01

WSM SEA-DOO PUMP WATER OUTLET

Sea-Doo	Part No.
580, 650, 720 (94-98), 800 (94-98)	003-700-01
720 (01-05), 800 (03-05), 951 (98-04)	003-710-01



A.



B.

WSM SEA-DOO JET PUMP OUTLET & FITTING

Sea-Doo	OEM#	Part No.
A. Jet Pump Outlet 580/650/720 Sold Individually	293700017	003-430
B. Jet Pump Fitting 580/650/720	293700019	003-431
A&B. Jet Pump Outlet Set (2 pcs of 003-430, 1 pc of 003-431)		003-432

FOUR
STROKE

INTAKE
SYSTEMS

ENGINE/
GASKETS

EXHAUST

DRIVE LINE
HANDLING

ELECTRICAL

WATERLINE
/BILGE

STEERING
& CONTROLS

BODY

ACCESSORIES
SERVICE TOOLS

/HARDWARE

CHEMICAL

SEA-DOO PUMP WEAR RINGS



003-500



003-503

WSM REPLACEMENT PUMP WEAR RINGS

Sea-Doo	O.E.M.	Part No.
580/650/720 (95-98)	271000290	003-500
800 Carb (95-98)/ 800 RFI (99-02)	(140mm ID)	
720 (99-05), 800 RFI (03-05)	271000653	003-503
951/4-Tec (02-03)		
4-Tec 130/155/185 HP (04-12)	267-000-104 (155.5mm ID)	003-502
4-Tec 215/255/260 HP (04-13)	267000105 (159mm ID)	003-499



WSM PUMP WEAR RING WITH STAINLESS STEEL

Sea-Doo	O.E.M.	Part No.
580/650/720 (95-98)	271000290	003-500S
800 Carb (95-98), 800 RFI (99-02)	(140mm ID)	
720 (99-05), 800 RFI (03-05)	271000653	003-503S
951/4-Tec (02-03)		
4-Tec 130/155/185 HP (04-12)	267-000-104 (155.5mm ID)	003-502S
4-Tec 215/255/260 HP (04-13)	267000105 (159mm ID)	003-499S



A.



B.

SOLAS STAINLESS STEEL REPLACEMENT WEAR RINGS FOR 4-TEC SEA-DOO & SPARK

Description	Part No.
A. 155mm Wear Ring	SR-HS-156-01
B. 159mm Wear Ring	SRX-HS-159-02
140mm Spark Wear Ring	SK-HS-140



RIVA RXP/RXT SS REPLACEMENT WEAR RING

Replaces original plastic unit with easy press in installation. Durable stainless steel resists debris damage and saltwater corrosion.

Sea-Doo PWC Application Chart:

- 155mm liner fits 185/155/135hp 4-Stroke units
- 159mm liner fits 255/215hp 4-Stroke units

Sea-Doo	Part No.
155mm SR Series	RS33-155-SR
159mm SRX Series	RS33-159-SRX



STAINLESS STEEL WEAR RING FOR SPARK

Replaces original plastic liner with easy installation. Durable, stainless steel resists debris damage and saltwater corrosion.

Description	Part No.
Solas Spark Wear Ring	SK-HS-140
RIVA Spark Wear Ring	RS33-140-SK
R&D Spark Wear Ring	133-50900
Skat-Trak Spark Wear Ring	REPAIRSDWR140
WSM Spark Wear Ring	003-501S



R&D ULTIMATE PUMP SEAL

- Seals pump 100%
- Eliminates cavitation
- Allows super fast Impellers to hook up without cavitation
- Improved acceleration and holeshot
- Easy install directly to stock location

Description	OEM#	Part No.
All 4-Tec (2003-08)	293200087	163-81500
All 4-Tec (2009), except 09 GTX LTD IS 255 & 09 RXT IS 255		
All GTI, RXP-X 255/RS, WAKE 155 (2010)		
GTI, GTS, RXP-X 255/RS, WAKE 155 (2011)		
All 4-Tec (2012-13)		
GTX LTD IS 255 & RXT IS 255 (2009)	293200122	163-81501
GTX, RXT, WAKE PRO 215 (2010-11)		
Spark	293200134	163-81590

SEA-DOO PUMP PARTS



WSM SEA-DOO JET PUMP REPAIR KITS

Most Kits Include: Oil Seals • O-Rings • Bearings

Sea-Doo	Part No.
580 All Models, 650 GTX (94-95), SPX (94-95), 650XP (93), 720 GTI (96), 720SPX (96)	003-640
650 XP (94-95), 650XPI (94), 720GS (97-01), 720GTI (97-01), 720 GTS (97-00), 720 HX (95-97)	003-641
800 All Models (95-02), 951GTX LTD (98), 951XP LTD (98)	003-643
720GTI (01-05), 720GTI LE (02-04), 720 GTS (01)	003-643
800 All Models (03-05), 951 All Models (99-07)	003-644
GTX 4-TEC ALL (02-03)	003-644
GTI All (03-13), GTX All (04-13), RXP All (05-08)	003-645
RXT All (05-13), WAKE All (07-13)	003-645



SEA-DOO PUMP HOUSING SEALS AND O-RINGS

Sea-Doo	Description	OEM No.	Part No.
GTX 4-TEC	Pump Seal	293-200-086	009-731-01T
580/650/720/800	Pump Seal	293-200-025	009-730-01
580/650/720/800	Pump Shaft Needle Bearings	293-350-001	54-3130
580/650/720/800	Pump O-Ring	293-300-046	008-640
		293-300-011	008-641
		293-300-013	008-642

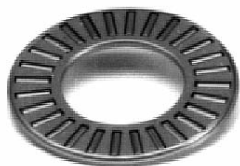

WSM SEA-DOO PUMP THRUST BEARINGS

Sea-Doo	OEM No.	Part No.
580-650-951 (97)	293-350-002	010-228-01
580-650-951 (98-01)	293-350-019	010-228-02
951 (Late)	213-350-022	010-228-03

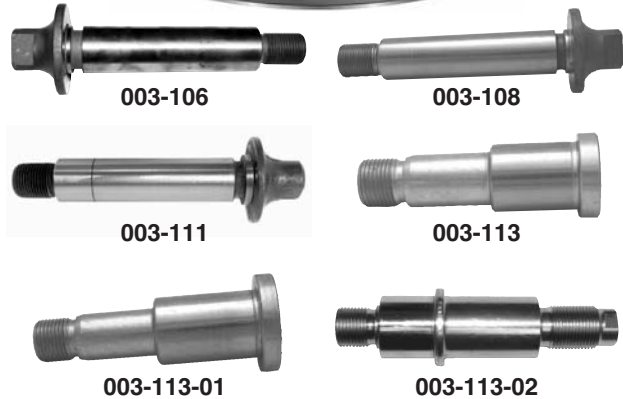

WSM REPLACEMENT SEA-DOO IMPELLER PUMP SHAFT

Sea-Doo	Part No.
O.E. No. 271000291, 271000595, 271000031 Fits: 580 All/650 All, 720 (95-00), 720 GS (01), 800 GSX All (96-00), 800 GTX All (96-02), 800 SPX (97-99), 800 XP (95-97)	003-106
O.E. No. 71000886, 271000743 Fits: 951 GSX, GTX, XP LTD. 98	003-108
O.E. No. 721000965 Fits: 720 All (01-05) Except GS 01, 800 All (03-05), 951 All (99-04)	003-111
O.E. No. 271001263 Fits: 4-Tec All (02-03)	003-113
O.E. No. 267000054 Fits: 4-Tec All (04-08)	003-113-01
O.E. No. 267000388 Fits: 4-Tec All (09-13)	003-113-02



IMPELLER SHAFT THRUST WASHER

Sea-Doo	Part No.
580/650/720 All	003-099
OEM#293-350-003	



008-640-01



008-640-02

WSM SEA-DOO 4-TEC PUMP PARTS

Sea-Doo	OEM#	Part No.
Watertight Seal for 4-tec (2003-12) 155.5mm pump	293250084	008-640-01
Jet Pump Reducer 4-tec (2003-12)	291001887	008-640-02

FOUR STROKE
INTAKE SYSTEMS
ENGINE/GASKETS
EXHAUST
DRIVE LINE HANDLING
ELECTRICAL
WATERLINE /BILGE
STEERING & CONTROLS
BODY
ACCESSORIES
SERVICE TOOLS /HARDWARE
CHEMICAL

YAMAHA COUPLERS & COUPLER SHAFTS

WSM REPLACEMENT COUPLER SHAFTS

MODEL	CC	YEAR	O.E. NO.	PART NO.			
Super Jet	650	1990-93	62E-51323-00-00	003-250			
			6R7-51323-00-00				
			6R7-51323-01-00				
			6R7-51323-02-00				
VXR	650	1991-93	61L-51323-01-00	003-254			
VXR	650	1995	6R7-51323-00-00	003-250			
			62E-51323-00-00				
			6R7-51323-01-00				
Wave Runner	650	1990-93	6R8-51323-00-00	003-258			
			Wave Runner		650	1995-96	6R8-51323-03-00
			6R8-51323-01-00				
			6R8-51323-02-00				
Super Jet	700	1995-2009	6R7-51323-01-00	003-250			
			Wave Blaster		700	1993-96	6R7-51323-02-00
			62E-51323-00-00				
			6R7-51323-00-00				
Wave Raider	700	1994-97	6R8-51323-01-00	003-258			
			Wave Runner		700	1994-95	6R8-51323-02-00
			Wave Runner		700	1997	6R8-51323-10-00
Wave Venture	700	1995-96	6R8-51323-00-00	003-251			
			Wave Venture		700	1998	63N-51323-10-00
			XL		700	1999-2004	
			GP		760	1999-2000	65V-51323-00-00
Wave Blaster	760	1996-97	64Y-51323-00	003-256			
			Wave Raider		760	1996	6R8-51323-00-00
			6R8-51323-01-00				
			6R8-51323-02-00				
Wave Runner	760	1997-98	65V-51323-00-00	003-257			
			Wave Blaster		760	1996-97	63N-51323-00-00
			XL		760	1998-99	63N-51323-10-00
			6R8-51323-03-00				
Wave Raider	760	1996	6R8-51323-10-00	003-258			
			6R8-51323-00-00				
			6R8-51323-03-00				
			6R8-51323-00-00				



MODEL	CC	YEAR	O.E. NO.	PART NO.
GP	800	1998	63M-51323-00-00	003-252
			63M-51323-01-00	
GP	800	2001	66V-51323-00-00	003-252
			66V-51323-01-00	
GP	800	2002-05	68N-51323-00-00	003-255
Wave Runner	800	2004		
XL	800	2000-01	66V-51323-01-00	003-253
			66V-51323-00-00	
XLT	800	2002-04	68N-51323-00-00	003-255
FX 140	1000	2002-08	60E-51323-00-00	003-259
Wave Raider	1100	1995-96	63M-51323-01-00	003-252
Wave Venture	1100	1996-97	63M-51323-00-00	
GP	1200	1997-99		
			GP	
GP	1200	2002	66V-51323-01-00	003-253
			66V-51323-00-00	
GP	1200	2002	68N-51323-00-00	003-255
SUV	1200	2003	66V-51323-00-00	003-253
SV	1200	2002-04	66V-51323-01-00	003-255
			66V-51323-00-00	
XL	1200	1998	63M-51323-00-00	003-252
XL	1200	1999-2000	63M-51323-01-00	003-252
			63M-51323-00-00	
XL	1200	1999-2000	66V-51323-00-00	003-253
XL	1200	2001	66V-51323-01-00	003-253
			66V-51323-00-00	
XLT	1200	2002-05		
GPR	1300	2003-08		
FX Cruiser HO	1800	2009-12	6S5-51323-00-00	003-260
FX Cruiser SHO	1800	2008-12		
FX HO	1800	2009-11		
FX SHO	1800	2008-12		
FZR	1800	2009-11		
FZS	1800	2009-12		
VXR	1800	2012		
VXS	1800	2012		



TOOL#61-5



TOOL#60-3

DRIVE COUPLER WRENCH

Yamaha	Part No.
144mm Pump	TOOL#60-3
155mm Pump	TOOL#61-5

NEW



SKAT-TRAK MID SHAFT WRENCH

This new Skat-Trak tool will insert a Yamaha mid shaft and allow you to hold it while removing the coupler, without damaging the shaft.

Description	Part No.
20mm Mid Shaft Wrench	RWRVAMMS



adaRACING

BILLET DRIVE COUPLER SET

Yamaha	Part No.
ADA Racing All Yamaha (except 63M/66E/66V)	34-700190
Utilizes Kawasaki Dampener Type* (Part No. 003-201)	
Crankshaft Side (27mm x 1.5mm threads)	34-700198
Driveshaft Side (24mm x 1.5mm threads)	34-700199

YAMAHA DRIVE SHAFTS & PUMPS



003-170



003-174



003-175



003-178

WSM REPLACEMENT DRIVE SHAFTS

MODEL	CC	YEAR	O.E. NO.	LENGTH	PART NO.
VXR	650	1991-95	61L-45511-00-00	32-3/4"	003-171
Super Jet	650	1990-93	6R7-45511-00-00	26"	003-170
Super Jet	700	1995	6R7-45511-01-00		
Super Jet	700	1996-2007			
Wave Blaster	700	1993-96	62E-45511-00-00	28-3/4"	003-172
Wave Runner	650	1990-96	6R8-45511-00-00	33-3/4"	003-174
Wave Raider	700	1994-97			
Wave Runner	700	1994-97			
Wave Venture	700	1996			
Wave Raider	760	1996			
Wave Venture	700	1998	65R-45511-00-00	34"	003-175
XL	700	1999-2003			
Wave Venture	760	1997			
XL	760	1998-99			
Wave Blaster	760	1996-97	64Y-45511-00-00	27"	003-176
GP	800	1998	66E-45511-00-00	35-3/4"	003-180
GP	800	2002-05	68Y-45511-00-00	28-1/8"	003-181
XA	800	2004	68Y-45511-01-00		
XLT	800	2002-03			
FX 140	1000	2002-04			
FX H.O.	1100	2005-08			
GP	1200	2002			
SUV	1200	2003-04			
SV	1200	2002			
XL	1200	2001			
XLT	1200	2002-05			
GP	800	2001	66V-45511-00-00	30"	003-178
XL	800	2000-01	66V-45511-01-00		
GP	1200	2000-01			
SUV	1200	1999-2001			
XL	1200	1999-2000			
GP	1300	2003-08			
Wave Raider	1100	1995-96	63M-45511-00-00	36"	003-177
Wave Venture	1100	1996-97			
GP	1200	1997-99	65U-45511-00-00	36-1/4"	003-179
XL	1200	1998			
FX	1800	2009-13	6S5-45511-00-00	29"	003-182
FX HO	1800	2009-13			
FX Cruiser	1800	2009-13			
VXR/VXS	1800	2012-13			
FZR	1800	2009-13	6AN0-45511-00-00	30-3/8"	003-182-01
FZS	1800	2009-13			

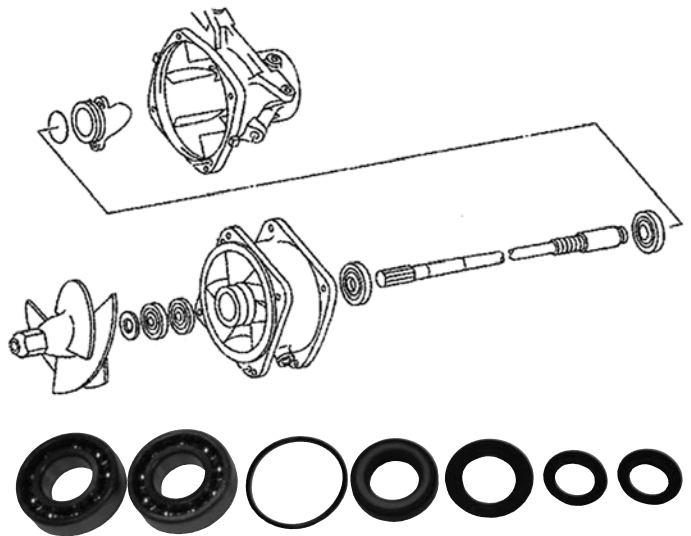

WSM JET PUMP REPAIR KITS

MODEL	YEAR	KIT NO.	MODEL	YEAR	KIT NO.
SJ 650	90-93	003-630	XL 800	00-01	003-627
VXR 650	91-95	003-630	XLT 800	02-04	003-627
WR III 650	90	003-630	FX 140	02-04	003-638
WR III 650	91-96	003-630	FX Cruiser	05-08	003-638
S.N. 8001001 & UP			1000 3 Passenger		
Blaster 700	93-96	003-630	FX HO 1100	05-08	003-638
FX1 700	94-95	003-630	3 Passenger		
Raider 700	94-97	003-630	Raider 1100	95-96	003-631
SJ 700	95-07	003-630	VX 1100	05-08	003-626
VXR Pro 700	93-94	003-630	All Models		
WR III 700	94-97	003-630	WV 1100	96-97	003-631
WV 700	95-96	003-630	GP 1200	97-99	003-629
WV 700	98	003-631	GP 1200	00-02	003-627
XL 700	99-03	003-631	SUV 1200	99-04	003-627
XL 700	04	003-629	XL 1200	98	003-629
Blaster 760	96-97	003-631	XL 1200	99-01	003-627
GP 760	99-00	003-629	XLT 1200	02-05	003-627
Raider 760	96	003-630	XLT 1200	03-05	003-638
WR 760	97-98	003-629	3 Passenger		
WV 760	97	003-631	GPR 1300	03-08	003-627
XL 760	98-99	003-631	FX 4-Stroke	02-08	003-627
GP 800	98-00	003-629	All Models		
GP 800	01-05	003-627	Super H.O.	08	NA
GP 800	02-05	003-638	FX 1800	09-13	003-628
2 Passenger			FZR 1800	09-13	003-628
			FZS 1800	09-13	003-628
			VXR 1800	11-13	003-628
			VXS 1800	11-13	003-628



2015 IJSBA QUAKYSENSE WORLD FINALS IN LAKE HAVASU CITY, ARIZONA.

YAMAHA BEARINGS HOUSING



003-400
Housing only

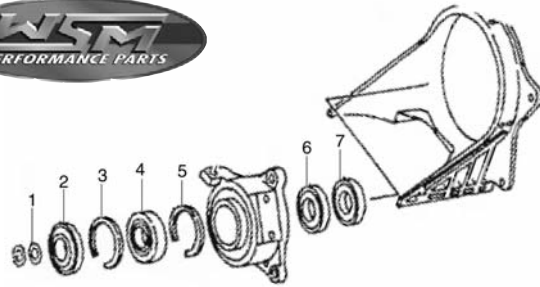

WSM YAMAHA BEARINGS HOUSING REPAIR KIT

WSM REPLACEMENT BEARING HOUSING

MODEL	CC	YEAR	O.E. NO.	PART NO.
650 All Models	650	1990-96	6R7-45332-02-9M	003-402
			6R7-45332-02-9M	Housing Only

Description	Part No.
Repair Kit for WSM 003-400-01, WSM 003-402-01 and OEM Housing	003-622

BEARING HOUSING INDIVIDUAL PARTS

MODEL	CC	YEAR	O.E. NO.	PART NO.
				003-402-01 Complete Assembly
FX1	700	1994	61X-45332-00-9M	003-400
Super Jet	700	1997-2013	61X-45332-02-97	Housing Only
VXR Pro	700	1993-94	61X-45332-02-94	
Wave Blaster	700	1993-94	61X-45332-03-94	003-400-01
Wave Raider	700	1994	66G-45332-00-94	Complete
Wave Runner III	700	1994	99999-02643-00	Assembly
Wave Runner III	700	1997		
Wave Blaster	760	1997-98		
Wave Venture	760	1997		
GP	800	2001-05		
XA	800	2004		
XL	800	2000-01		
XLT	800	2002-03		
FX	1000	2005-08		
FX 140	1000	2002-04		
FX Cruiser	1000	2003-08		
FX Cruiser HO	1100	2004-08		
FX Cruiser HO	1100	2006		
Anniversary				
FX HO	1100	2004-08		
VX Cruiser	1100	2010-13		
VX Deluxe	1100	2010-13		
VX Sport	1100	2010-13		
GP	1200	1997		
GP	1200	2000-02		
SUV	1200	1999-2004		
XL	1200	2001		
XL Limited	1200	1999-2000		
XLT	1200	2002-05		
GP-R	1300	2003-08		
Wave Venture	700	1998	65A-G5331-00	003-403
XL	700	2000-04		Housing Only
GP	760	1999-2000		
Wave Venture	1100	1997		
GP	1200	1997-99		
XL	1200	1998		
FX Cruiser SHO	1800	2008-11	6S5-45332-00-94	003-406
FX HO	1800	2009-11		Housing Only
FX SHO	1800	2008-11		
FZR	1800	2009-11		
FZS	1800	2009-10		
VXR	1800	2011		
VXS	1800	2011		



003-400-01



003-403

155MM YAMAHA PUMP SEAL



Fits both OEM Yamaha and Skat-Trak Billet Magnum Pumps

Description	Part No.
R&D 155mm Yamaha Pump Seal	162-70800
Thrust Innovations 155mm Yamaha Pump Seal	TI-155-PMP-SL



ROSS WALLACH OF RPM RACING SPEAKS AT THE 2015 HOT PRODUCTS LB2CAT (LONG BEACH TO CATALINA) RACE BANQUET. PHOTO COURTESY OF MARK GERNER OF PWCOFFSHORE.COM.

YAMAHA PUMP HOUSING



003-505



003-506



003-505-01



003-507



Replacement Wear Rings (Sold Individually)	Part No.
Fits 003-506 and 003-507 (144mm)	003-521
Fits 003-505 (155mm)	003-520
Fits 003-508	003-522



YQS-SV-144/74



YSS-SV-160/74



YVS-SV-160/74

SOLAS STAINLESS STEEL YAMAHA 12-VANE STATOR SECTION

Pump Size	Hub Size	Part No.
144mm	74mm	YQS-SV-144/74
148mm	74mm	YRS-SV-148/74
160mm	74mm	YSS-SV-160/74
(SHO only, small water cooling outlet)		
160mm	74mm	YVS-SV-160/74
(SVHO & SHO, larger water cooling outlet)		



YBS-HS-144



YRS-HS-148



YDS-HS-155



YFS-HS-155



YVS-HS-160

SOLAS STAINLESS STEEL YAMAHA PUMP HOUSING

Pump Size	Application	Part No.
144mm	-	YBS-HS-144
148mm	-	YRS-HS-148
155mm	Yamaha 700-1200cc	YDS-HS-155
155mm	Yamaha 800-1300cc	YFS-HS-155
160mm	-	YVS-HS-160



003-508



Description	Part No.
Yamaha 800-1300	003-730

WSM OEM REPLACEMENT 6 VEIN STATOR

OEM #660-51315-00-94

WSM REPLACEMENT JET PUMP HOUSING WITH WEAR RINGS

MODEL	CC	YEAR	O.E. NO.	PART NO.
Wave Venture	700	1998	63M-51312-00-94	003-505
XL	700	1999-2004	63M-51312-01-94	
Wave Venture	760	1997	63M-51312-02-94	
Wave Raider	1100	1995-96		
Wave Venture	1100	1996-97		
GP	1200	1997-99		
Wave Blaster	760	1996-97	64Y-51312-00-94 64Y-51312-01-94	003-505-01
Wave Runner III	650	1990-96	6R8-51312-00-94	003-506
Wave Runner LX	650	1991	6R8-51312-01-94	
Wave Raider	700	1994-96	6R8-51312-02-94	
Wave Runner III	700	1994-97	6R8-51312-03-94	
Wave Venture	700	1995-96		
GP	760	1999-2000		
Wave Raider	760	1996-97		
Wave Runner	760	1997-98		
GP	800	1998-2000		
Super Jet	650	1990-93	6R7-51312-00-94	003-507
VXR	650	1991-95	6R7-51312-01-94	
Super Jet	700	1995-2009	6R7-51312-02-94	
VXR Pro	700	1993-94	6R7-51312-03-94	
Wave Blaster	700	1993-96		
GP	800	2001-05	66V-51312-00-94	003-508
Wave Runner III	800	2004	66V-51312-01-94	
XLT	800	2002-03	66V-51312-02-94	
FX All Models	1000	2002-03	66V-51312-03-94	
FX H.O.	1100	2004-05		
All Models				
VX All Models	1100	2005-09		
GP	1200	2001-02		
SUV	1200	2003-04		
SV	1200	2002		
XL	1200	2001		
XLT	1200	2002-05		
GP	1300	2003-08		
FX SHO	1812	2009		

FOUR
STROKE

INTAKE
SYSTEMS

ENGINE/
GASKETS

EXHAUST

DRIVE LINE
HANDLING

ELECTRICAL

WATERLINE
/BILGE

STEERING
& CONTROLS

BODY

ACCESSORIES
/SERVICE TOOLS

HARDWARE

CHEMICAL

NEW MSD PRICING POLICY EFFECTIVE JANUARY 31st, 2016

MSD has announced effective January 31st, 2016 that MAP (Minimum Advertised Pricing) will be enforced for US retailers. Any US retailer selling MSD products below the MSD 2016 MAP pricing will lose the ability to purchase MSD products. The Hot Products price list only shows the MSD 2016 MSRP, please contact Hot Products for the MAP pricing. MAP Pricing is not in effect for Retailers located out of the USA.

MULTI-CHANNEL RACING IGNITION SYSTEMS FOR YAMAHA 650/701/760

Precise ignition timing is essential to produce maximum horsepower. However, one timing setting is not ideal for an engine's entire rpm range. The dynamics of air and fuel flow into the engine as well as the speed that the piston travels through the combustion stroke all affect the ideal timing setting. Fortunately, the Programmable MSD Ignition lets you tune in a custom timing curve to match your engine's requirements.

There are three settings that you program to create a timing curve. First you set where you want the initial timing, or idle timing. Next you set the rpm point to begin the curve, followed by the amount you want it to retard (up to 30°) through the high rpm limit. All the adjustments are made with dip switches built into the ignition.

This Ignition delivers a powerful capacitive discharge spark from idle to top end. This improved output results in complete combustion for performance through the entire rpm range of your engine.



Description	Part No.
Yamaha 650/701/760 Total Loss	42380

Kit Contains the following:

Description	Part No.
Pro-Digital Programmable Ignition Unit	42351
Trigger Plate	4311
Pick Up Total Loss Universal (2)	4316
Coil (2)	42921
Coil Bracket	4570
Wire Set	31009
Flywheel	43032



MSD PRO-DIGITAL PROGRAMMABLE IGNITION

Description	Part No.
MSD Pro-Digital Programmable Ignition (unit only)	42351



MSD TOTAL LOSS PICK UP

Description	Part No.
Pick Up Total Loss Universal	4316
Pick Up Yamaha 800/1100/1200	43161
Timing Tape, Sea-Doo	LAB17344
Timing Tape, Yamaha 1200/800	LAB19722
Magnets, Round 2 pcs/set	4309

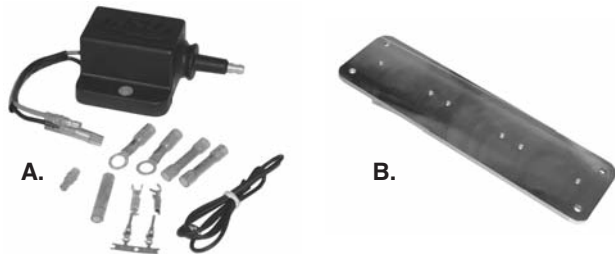

MSD COILS

COIL SPECIFICATIONS:

Turn Ratio: 70:1 Primary Resistance: 0.2 OHMS
 Secondary Resistance: Less than 2000 ohms Max Voltage: 30 KV

Description	Part No.
A. Single Tower Pro Coil	42921
B. Pro Coil Bracket (Holds up to 3 Pro Coils)	4570

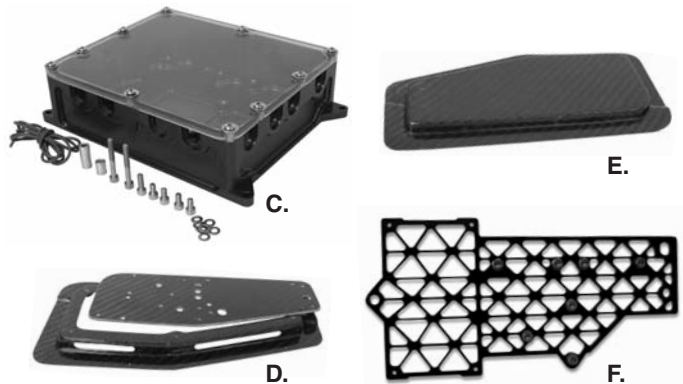

RRP ELECTRICAL ACCESSORIES

Description	Part No.
C. RRP Aluminum Electric Box for MSD Total Loss Ignition - Black	RRP-AL-EL-BOX-BLK
D. RRP Electrical Plate Carbon Fiber for MSD Component (2 piece system)	EL-PLT-MSD
E. RRP Electrical Plate Carbon Fiber to glue on side wall of hull	EL-PLT-YAM
F. Blowson Total Loss Ignition Billet Plate - Black	01-04-419



MSD TRIGGER PICKUP PLATE

Description	Part No.
Yamaha 650/701/760	4311

FOUR STROKE
 INTAKE SYSTEMS
 ENGINE/GASKETS
 EXHAUST
 DRIVE LINE HANDLING
 ELECTRICAL
 WATERLINE /BILGE
 STEERING & CONTROLS
 BODY
 SERVICE TOOLS ACCESSORIES /HARDWARE
 CHEMICAL

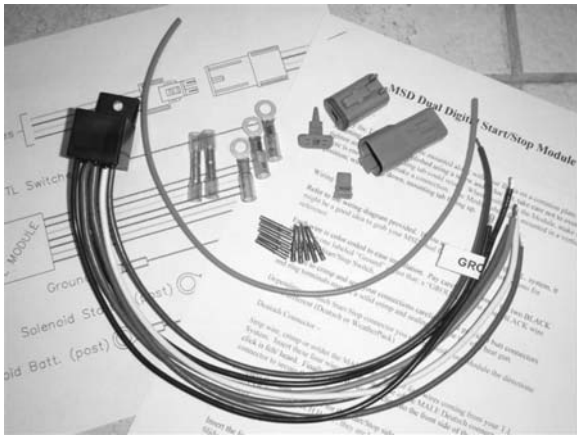

THRUST INNOVATIONS MSD START/STOP MODULE

The Thrust Innovations module terminates the need for a toggle switch to power off your MSD Total Loss Ignition. Easy to install instructions with picture diagram included.

Waterproof module that will allow your OEM start/stop switch to function just like it was meant to, while running Total Loss, without the need for an additional switch.

- Starts just like OEM (only when lanyard is attached)
- Kills motor and powers down Total Loss once lanyard is removed or "STOP" button is touched momentarily
- Does not draw from battery, will not cause battery drain
- Sealed and potted to ensure water resistance and to isolate from shock
- All connections are soldered
- Comes with OEM connections to attach directly to your start/stop switch

Description	Part No.
Total Loss Ignition Start/Stop Module	TI-MSD-TL-MD

MSD POWERSPORTS



4251

MSD KAWASAKI 750 ENHANCER

The Kawasaki 750 Enhancer features the increased spark energy you expect from MSD plus they have an adjustable rev limiter and holeshot rpm limit. The rev limit is adjusted with a potential on the back of the ignition housing. The holeshot feature lets you activate a lower rpm limit that is best to use for quick starts at the beginning of a race. Also, these ignitions can be connected to the factory overheat sensor. With this feature, if the water temperature gets too high, the Enhancer will limit the rpm to a safe value to avoid any engine damage.

Note: Enhancer will not work on 1996 ZXi.

Description	Part No.
Kawasaki 750 SX/SXI/95ZXI	4251



4253

MSD YAMAHA 650/701 ENHANCER

At lower rpm you'll notice incredible acceleration and throttle response due to advancing the timing. Then as the rpm increases, the timing is retarded to the factory setting to prevent detonation and engine damage. For racers, there is also a lower rpm limit that you can activate for quick and consistent holeshots. Everything you need to install the Yamaha Enhancer is supplied along with factory connectors for a direct plug-in installation!

Not compatible with Yamaha 760 engine applications.

Description	Part No.
Yamaha 650/701	4253



4255

MSD SEA-DOO 800 ENHANCER

The Enhancer Ignition for the Sea-Doo® 800 (also the '95, '96, XP and GSX) uses a high speed RISC microprocessor to control all of the timer and rev limiter functions. This opens the door for programming, giving you the ability to set two rev limits and a timing curve through a series of dip switches built into the Enhancer. Being able to control the ignition curve lets you match the timing specifically to your engine and its modifications. The Digital Enhancer produces a series of sparks through 3,000 rpm rather than just a single spark. This feature delivers incredible throttle response, acceleration and keeps the idle clean and smooth. Note: This modification will eliminate the factory DSS security system and the handlebar kill feature.

Description	Part No.
Sea-Doo 800 '95-'96, '97-'98 SPX, GTX	4255



MSD STOCK IMPROVED COIL

Replace your old factory coil with this direct bolt-on.

- Replaces Stock kawasaki & Yamaha Coils
- Molded -In 8.5mm Super Conductor Wires
- Output Voltage - 30KV • Primary Resistance - .08 OHM
- Secondary Resistance - 2K OHMS
- Used with Enhancer Ignition for Yamaha 650/701 and Kawasaki 750 only

Description	Part No.
Stock Improved Coil for Start-Up	4294

FOUR
STROKE

INTAKE
SYSTEMS

ENGINE/
GASKETS

EXHAUST

DRIVE LINE
HANDLING

ELECTRICAL

WATERLINE
/BILGE

STEERING
& CONTROLS

BODY

ACCESSORIES
SERVICE TOOLS

HARDWARE

CHEMICAL



MSD SPARK PLUG BOOT RETAINERS

There's no excuse for losing a race due to a plug wire popping off when you run MSD's Boot Retainers. These handy clamps are molded from heat resistant nylon material and will lock the boot to the spark plug.

Description	Part No.
Boot Retainer, 90° Spark Plug Boots & Terminal (2 cyl.)	3340
Boot Retainer, individual piece	15991



MSD SPARK PLUG BOOT & TERMINALS

Description	Part No.
A. MSD 90° Spark Plug Boots & Terminal (2 cyl.)	3311
A. MSD 90° Spark Plug Boots & Terminal (3 cyl.)	3311-3
B. MSD Spark Plug Terminals (Pack of 100)	34615
B. MSD Spark Plug Terminals (Pack of 10)	34615-10



MSD 8.5MM SUPER CONDUCTOR SPARK PLUG WIRE

Spark plug wires have two main objectives; transfer the spark energy and suppress the Electro Magnetic interference (EMI) that the spark voltage creates. The MSD 8.5mm Super conductor delivers the best of both worlds. MSD uses a special copper conductor keeping resistance under 50 ohms per foot! Even with this low resistance, the wire retains high EMI suppression capabilities. By wrapping the conductor tightly around a ferro-magnetic impregnated center core and EMI choke is created, keeping any interference inside the wire.

Description	Part No.
Two Cylinder Wire Set	31009
One Cylinder Wire Set	31019
Three Cylinder Wire Set	31039



MSD EXTERNAL STARTER RELAY

This 12 volt relay is a heavy duty unit designed to mount outside the electrical box. It's made with material that locks out moisture and chemicals. The large copper terminals assure good solid contact with your wiring. The stainless steel base plate allows the relay to be mounted in any position. Rated at 65 amps.

Description	Part No.
MSD External Starter Relay	M4390



MSD BULK SUPER CONDUCTOR SPARK PLUG WIRE

Description	Part No.
Bulk Wire 25 feet - Red	34019
Bulk Wire 25 feet - Black	34013

MSD DUAL WIRE SEPARATORS

These handy separators will secure two wires and keep them away from the exhaust or moving parts. Each wire can be moved easily and clipped right back in! Sold in a pack of 16.



Description	Part No.
Dual Wire Separator (pack of 16)	8841



MINI STRIPPER-CRIMPER

Designed to be in a vise and with a single-edge razor blade to strip spark plug wires without damaging the core and to crimp a terminal. Inexpensive too!

Description	Part No.
Mini Stripper-Crimper	3503

SPARK GUARD

MSD's Spark Guard is a dielectric grease that solves many common ignition troubles. It stops voltage leaks, eases boot removal, prevents moisture buildup inside the spark plug wire boots, and even helps protect against radio noise (EMI). It also simplifies the installation of MSD Universal Spark Plug Wire Sets. Spark Guard will not dry up or harden, so it will retain its spark isolating capabilities indefinitely.



Description

MSD Spark Guard (0.5 oz.)

Part No.

M8804



3506



3507



3508



3509

MSD PRO-CRIMP TOOL

To do a job right, it is important to have the right tools. If you custom build a lot of plug wires, the Pro-Crimp is the right tool for you! The Pro-Crimp features a hardened steel frame, molded hand grips and built-in ratchet action that is also adjustable.

Description

MSD Pro Crimp Tool (Includes #3508)

Part No.

35051

Amp Pins

3506

Amp Lug Dies

3507

Spark Plug Dies

3508

Weathertight Dies

3509

Deutsch Terminal Dies

3510



IGNI-PRO PROGRAMMABLE IGNITION

The best is now even better! The all new updated Igni Power ignition does not require battery power like previous Igni Power ignitions or OEM Kawasaki CDI's when the engine is not running, thus eliminating the battery draw down issue of the past. Igni Pro is a high power ignition which is fully programmable with any computer or laptop. Simple and easy to connection via a USB cable. This allow you to program your ignition to your specific engine modifications and any future changes to your engine package. This ignition upgrade will increase power with any modification even you utilize the OEM stock pipe. The ignition can be operated as a total loss system with a TBM total loss flywheel. This system fits perfectly in the OEM ignition box for reliability. Supplied with complete instructions and programming software (all Windows).

Description

Igni-Pro Programmable Ignition 800 SX-R

Part No.

IGNI800SXR



X-TREME TAPE® SELF-FUSING SILICONE RUBBER TAPE

X-Treme Tape is the Original self-fusing silicone insulating & repair wrap.

Originally developed for U.S. Military applications, X-Treme Tape has been tested and proven in the most extreme conditions and environments. It is the most versatile and easy-to-use quick-fix emergency rescue repair tape available. X-Treme Tape withstands extremes in temperature, pressure, voltage, moisture, corrosion and contaminants.

Tests show the bonding strength of X-Treme Tape greatly exceeds the Mil-Spec standard and that of competing brands of tape.

X-Treme Tape:

- Is Self-Fusing...No Adhesive
- Withstands Over 500°F (260°C) of Heat
- Remains Flexible to -85°F (-60°C)
- Has an Amazing 700 PSI Tensile Strength
- Insulates to 8,000 Volts per Unstretched Layer
- UL Listed
- Stretches 300%
- Made in the USA!



X-Treme Tape's strength comes from both its thickness and the advanced bonding characteristics of the special silicone formula. X-Treme Tape has approximately 15% more material/thickness than rival brands making it the most reliable product available!

- Creates an Air-Tight, Water-Tight Seal in seconds!
- Never gets goopy or sticky like old-fashioned electrical tape or duct tape - No messy cleanup!
- Has an incredibly long shelf life!
- Is extremely versatile!
- Resists Acids, Fuels, Oils, Solvents, Salt Water, UV Rays



Scan QR Code to see X-Treme Tape How-To Video



Tape thickness .020" (.5mm) Tape width 1" (25.4mm)
Roll length 10' (3 meters)

Color

Black

Part No.

TPE-X10B

Blue

TPE-X10BLU

Bright Red

TPE-X10BRD

Green

TPE-X10GRN

White

TPE-X10W

Yellow

TPE-X10YEL

FOUR STROKE
INTAKE SYSTEMS
ENGINE/GASKETS
EXHAUST
DRIVE LINE HANDLING
ELECTRICAL
WATERLINE /BILGE
STEERING & CONTROLS
BODY
ACCESSORIES
SERVICE TOOLS /HARDWARE
CHEMICAL

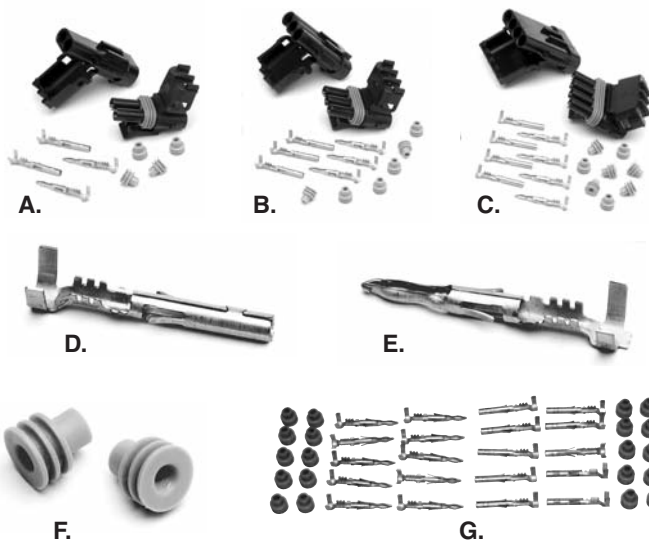

HOT PRODUCTS WEATHER PACK CONNECTORS

Ideal for use in harsh environments. Positive snap-action locking. Secondary locking helps terminal retention and provides access to the terminals for service.

Description	Part No.
A. 2 Way Housing Kit	55-2060
B. 3 Way Housing Kit	55-2061
C. 4 Way Housing Kit	55-2062
D. Female Terminal Only 100/pk	55-2070
E. Male Terminal Only 100/pk	55-2071
F. Cavity Seals Only 100/pk	55-2072
G. 10 pieces each of Female Terminal, Male Terminal and 20 pieces of Cavity Seals	55-2095



Weathertight



Grey Deutsch

MSD WEATHERTIGHT

Description	Part No.
6 Pin Connectors	8170
4 Pin Connectors	8171
3 Pin Connectors	8172
2 Pin Connectors	8173

MSD GREY DEUTSCH CONNECTORS

Description	Part No.
8 Pin Connectors	8185
6 Pin Connectors	8180
4 Pin Connectors	8181
2 Pin Connectors	8183

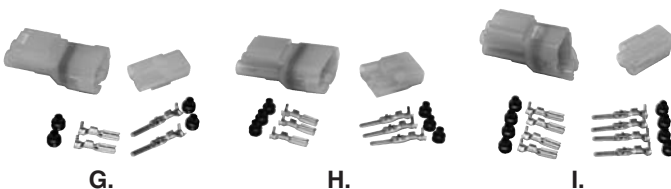

WATERPROOF TERMINAL KIT

Japanese OEM type connector Kit. Made in Japan.

Description	Part No.
G. 2-Pin Terminal Kit	16-622
H. 3-Pin Terminal Kit	16-623
I. 4-Pin Terminal Kit	16-624

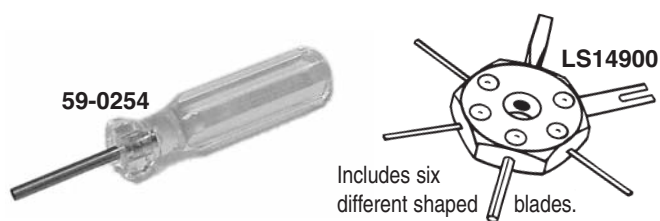

59-0254

LS14900

Includes six different shaped blades.

TERMINAL DETENT TOOL

The hollow barrel allows you to depress the tab on the terminal end and to remove the wire from the connector without damaging its ends.

Description	Part No.
Terminal Detent Tool	59-0254
Terminal Removal Tool	LS14900



DEUTSCH REMOVAL TOOL

This stainless steel tool is designed to easily disassemble Deutsch connectors. The flat end slides under plug wedges to release them from the housing. The hook end hooks onto the receptacle wedge to release from the housing and it can separate holding fingers to allow for the pin and socket to be removed.

Description	Part No.
Deutsch Connectors Removal Tool	14114100



DEUTSCH CONNECTOR KIT

- Perfect for creating UV/weather-resistant, multi-pin connections.
- An assortment of 224 pieces, including housings, terminals and wedges
- All contained in a durable carrying case (11" x 6-3/4" x 1-3/4")

Description	Part No.
Deutsch Connector Kit	14114020

Contents Description	Replacement Receptacle	Qty	Replacement Plug	Qty
2-way housing	14062200	3	14062100	3
3-way housing	14063200	3	14063100	3
4-way housing	14064200	2	14064100	2
6-way housing	14066200	1	14066100	1
8-way housing	14068200	1	14068100	1
12-way housing	14061200	1	14061210	1

Description	Replacement Receptacle	Qty	Replacement Plug	Qty
2-way wedge	14162200	3	14162100	3
3-way wedge	14163200	3	14163100	3
4-way wedge	14164200	2	14164100	2
6-way wedge	14166200	1	14166100	1
8-way wedge	14168200	1	14168100	1
12-way wedge	14161220	1	14161210	1

Description	Guage	Replacement Pin #	Qty	Replacement Socket #	Qty
Stamped/formed	18-16	14601622	40	14621622	40
Nickel, solid crimp	18-16	14602024	40	14622014	40
Sealing plug	-	14114017	-	14114017	20

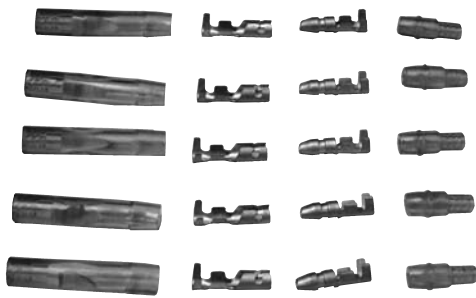

55-2035 - (5 pcs/pk)

JAPANESE OEM STYLE CONNECTOR

Made in Japan.

Description	Part No.
OEM Style Electric Connector Kit (5 pcs/pk)	55-2035
Dealer Kit (20 pcs/pk)	55-2037
Manufacturer Kit (100 pcs/pk)	55-2039

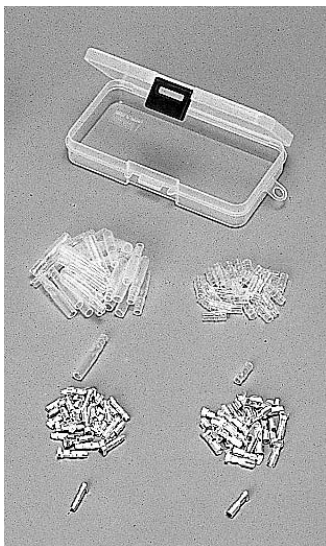

MALE/FEMALE TERMINAL KIT

This kit includes 30 of both the male and female terminals and plastic sleeves/covers. The terminals are tin plated to prevent corrosion. The terminal kit is provided in a handy plastic case. Made in Japan.

Description	Part No.
Male/Female Terminal Kit	16-601



EPOXY LINED ON THE INSIDE OF THE TUBING



EPOXY LINED HEAT SHRINK TUBING

High performance epoxy lined 1/2" id heat shrink. Just splice your wires, heat until the epoxy liquifies and your worries of possible water damage/corrosion are over! Heat shrink tubing color is Black.

Description	Part No.
Epoxy Lined Heat Shrink Tubing (4' length, 1/2" ID)	55-2032



ADHESIVE LINED HEAT SHRINK BUTT CONNECTORS

Best used where moisture and corrosion is a problem. After crimping these terminals to wire, heat is applied enabling the adhesive within each shrunk tube terminal to melt and flow evenly to seal the connection against the harshest environment.

Description	Wire Range	Part No.
10pcs/pk Pink	22-18 (0.3-0.8mm)	55-2040
100pcs/pk Pink	22-18 (0.3-0.8mm)	55-2041
10pcs/pk Blue	16-14 (1-2mm)	55-2042
100pcs/pk Blue	16-14 (1-2mm)	55-2043



ADHESIVE LINED HEAT SHRINK RING TERMINALS

Description	Wire Range	Part No.
10pcs/pk Blue	16-14 (1-2mm)	55-2080
100pcs/pk Blue	16-14 (1-2mm)	55-2081
10pcs/pk Pink	22-18 (0.3-0.8mm)	55-2082
100pcs/pk Pink	22-18 (0.3-0.8mm)	55-2085

NEW



HOT PRODUCTS ELECTRIC CONNECTORS AND TERMINALS KIT

- Japanese OEM style connector (20 pcs)
- Adhesive Lined Heat Shrink Butt Connector 22-18 Pink (20 pieces)
- Adhesive Lined Heat Shrink Butt Connector 16-14 Blue (20 pieces)
- Adhesive Lined Heat Shrink Ring Terminal 22-18 Pink(20 pieces)
- Adhesive Lined Heat Shrink Ring Terminal 16-14 Blue (20 pieces)
- 6-11/16" x 3-5/16" Compartment (1 piece)

Description	Part No.
Electric Connectors and Terminal Kit	53-2123



ECU WIRE HARNESS PINS

Description	Part No.
ECU Wire Harness Pins for Yamaha VX110 & others 5 pieces per pack	PM44722

FOUR STROKE
INTAKE SYSTEMS
ENGINE/GASKETS
EXHAUST
DRIVE LINE HANDLING
ELECTRICAL
WATERLINE /BILGE
STEERING & CONTROLS
BODY
ACCESSORIES
SERVICE TOOLS
HARDWARE
CHEMICAL



TBM124-KAW



TBM124-YAM

TBM RACING CHARGING FLYWHEEL

Lightweight charging flywheel.
Yamaha flywheel weighs: 2.05 lbs.
Kawasaki flywheel weighs: 2.35 lbs.

Description	Part No.
TBM Racing Charging Flywheel for Yamaha 701 (62T)	TBM124-YAM
TBM Racing Charging Flywheel for Kawasaki 750-800	TBM124-KAW



TBM RACING 800 SXR TOTAL LOSS FLYWHEEL

TBM's flywheel is compatible with the stock ignition in 2004-06 models and any aftermarket ignition system. This is the lightest flywheel on the market saving over 3 lbs vs. the stock flywheel.

NOTE: 2003 SXR's require the use of an aftermarket ignition.

Description	Part No.
TBM Racing 800 SXR Total Loss Flywheel for Kawasaki	TBM124



TBM RACING 1100 TOTAL LOSS FLYWHEEL

Weighing in at 2.2 lbs (stock is 4.0 lbs.), you will gain a tremendous increase in acceleration and midrange power simply by bolting on this masterpiece.

Description	Part No.
TBM Racing 1100 Total Loss Flywheel	TBM124-1100

TBM BILLET CHARGING FLYWHEEL FOR HYDROSPACE

Description	Part No.
Hydrospace S4 Charging Flywheel	TBM124-HS

* Hydrospace flywheel uses the same puller as Kawasaki charging flywheel (TBM152).



TBM RACING 750/800 KAWASAKI CHARGING FLYWHEEL PULLER

Description	Part No.
TBM Racing 750/800 Kawasaki Charging Flywheel Puller	TBM152



J305



J315
Outside of
Flywheel



J315
Inside of
Flywheel

JETINETICS CHARGING FLYWHEEL

Jetinetics is the originator of the charging aluminum flywheel, and proudly retains the manufacturing right to its patented design. The patented Jetinetics Charging Flywheel is significantly lighter, 50% in some cases, which greatly reduces the energy used to overcome flywheel mass and allow the engine to increase rpms rapidly. A significant benefit is the fact that the engine will produce horsepower only after it has reached its powerband, which usually begins about 3800 rpm. By using a Jetinetics Charging Flywheel, the engine is able to reach its powerband much more quickly and create usable power much sooner. Further, during rapid cornering such as course racing or slalom runs, this becomes a significant factor for acceleration.
Kawasaki flywheel weighs: 2.15 lbs.
Yamaha flywheel weighs: 2.65 lbs.

Description	Part No.
Yamaha 701 (62T)	J315
Kawasaki 750/800	J305
Kawasaki 550	J302
Kawasaki 650	J304

FLYWHEEL/MAGNETO PULLER



Sea-Doo	Part No.
A. 800/951 38mm x 1.5	MP#42

Kawasaki	Part No.
A. 900/1100 35mm x 1.5	MP#29
A. 1200 STX-R, Ultra 150 33mm x 1.5	MP#64

Sea-Doo	Part No.
B. 580/650/720 12 Hole Disc 8mm Bolts	MP#37

Polaris	Part No.
B. Polaris All & Universal 12 Hole Disc 8mm Bolts	MP#37

Yamaha	Part No.
B. 580/650/Pre 94 701 12 Hole Disc 8mm Bolts	MP#37
B. 701/760/800/1100/1200 12 Hole Disc 8mm Bolts	MP#37

Kawasaki	Part No.
B. 300/440/550/650 12 Hole Disc 8mm Bolts	MP#37
C. 750/800 Special 18mm x 1.5 Right Hand Bolt	MP#18

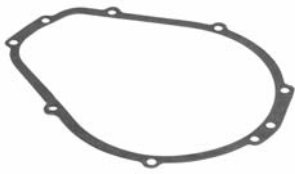

FLYWHEEL COVER & HOUSING GASKETS, O-RINGS & OIL SEALS

Sea-Doo Flywheel Cover O-Rings	OEM#	Part No.
580 (88-91)	290-950-130	6280
580/650/720 (92-98)	290-831-555	6278
800 (95-99)	420-950-360	6632
950 (98-99)	290-931-690	6795

Sea-Doo Flywheel Housing Gaskets	OEM#	Part No.
580/650/720	290-850-605	6130
800	290-931-470	6045

Yamaha	OEM#	Part No.
650/701/760	6M6-81365	2360
1100/1200	63M-81365	4505
1200XLL/GP1200R/1300R (Oil Seal)	93102-35M57	3710

Kawasaki	OEM#	Part No.
440/550 (O-Ring)	92055-521	008-417
650/750/800 (O-Ring)	92055-3712	008-418
Ultra 150	11060-3803	7790



010-480



010-481

SEA-DOO FLYWHEEL NUT & WOODRUFF KEY

Sea-Doo	MODELS	OEM#	Part No.
Flywheel Nut	All Models	420-842-230	010-480
Woodruff Key	All Models	420-246-055	010-481

FLYWHEEL BOLTS & WOODRUFF KEYS

Kawasaki	MODELS	OEM#	Part No.
Flywheel Bolts	All Models	92150-381	010-491
Flywheel Key	All Models	92038-001	010-481-01

Yamaha	MODELS	OEM#	Part No.
Flywheel Key	All Models	90280-16053-00	010-481-02



JETTRIBE "BEST OF THE WEST" SERIES ROUND #1 & #2 -
APRIL 11TH & 12TH - 2ND ANNUAL LAKE HAVASU OPEN OF
WATERCROSS - GARY HART MEMORIAL RACE (WINDSOR 4 BEACH)



R&D KAWASAKI 750 & 800 SX-R TIMING ADVANCE KIT

The R&D SX-R 800 Timing kit produces a substantial performance gain with the OEM ignition system. By relocating the pickup trigger on the ignition cover a full six degrees of ignition timing is available. Initial ignition timing from 0-2000 rpm boosted from 14 to 20 degrees, mid 3000-5000 rpm from 20 to 26 degrees and overall 6500 rpm + from 12 to 18 degrees.

Description	Part No.
R&D 750/800 Timing Advance Kit	441-75001
Replacement Timing Cover Gasket Only	8050



PJS TIMING ADVANCE PLATE KAWASAKI 750/800

This plate will allow you to advance the timing of your Kawasaki 750 and 800. The recommended timing advance is 6 degrees. This kit includes the shim (washer) for the starter bendix.

You must use a thick timing cover gasket (Part 8050) for the proper clearance or engine damage will occur. Gasket is sold separately.

Description	Part No.
PJS Timing Advance Plate for 750/800	EN00010
Replacement Timing Cover Gasket Only	8050



ADA RACING TIMING ADVANCE PLATE KAWASAKI 12F AND 15F

This is a stock timing trigger plate that is machined with additional locations for timing advance. Has the stock position, +3, +4, and +5 degrees. This fits the Kawasaki STX-15F and STX-12F four stroke watercraft.

Description	Part No.
ADA Racing Timing Advance Plate	31-250100

FOUR STROKE
INTAKE SYSTEMS
ENGINE/GASKETS
EXHAUST
DRIVE LINE HANDLING
ELECTRICAL
WATERLINE /BILGE
STEERING & CONTROLS
BODY
ACCESSORIES
SERVICE TOOLS /HARDWARE
CHEMICAL



NEW MES AQUA TORQUE STARTERS AND STARTER DRIVES



MES "High Torque" models and OEM equivalent models.
All starters meet or exceed OEM specification.



S1090MHT
S1090M



S1091MHT • S1091M
*Complete as shown with
mounting bracket



S1096MHT-9
S1096M-9
*9 Tooth Bendix



S1098MHT
S1098M



S1102M

Sea-Doo Model	OEM#	High Torque Starter	OEM Replacement Starter	Drive Gear Idle Gear
GT, SP, XP580 89-91	278-000-316	S1090MHT	S1090M	3275M/3276M
SP, SPL, SPX580 91-94	278-000-316	S1090MHT	S1090M	3275M/3276M
XP650 91-94(all)	278-000-316	S1090MHT	S1090M	3275M/3276M
580/650/720 94-00(all)	278-000-485	S1091MHT	S1091M	3275M/3276M
XP800 95, XP/GSX/GTX96	278-000-577	S1096MHT-9	S1096M-9	3275M/3276M
951(all)	278-000-98Z	S1098MHT	S1098M	3270M
4 Tec (4 Stroke)	290-888-999	-----	S1102M	-----
97-2003 GSX, SPX, GTX RFI, GSX RFI & 2003 GTI RFI	278-001-497/278-001-038 278-001-301	S1096MHT-8	S1096M-8	Not Required



S1095MHT
S1095M



S1099MHT
S1099M



S1103M



S1101M



S1097MHT

Yamaha	OEM#	High Torque Starter	OEM Replacement Starter	Drive Gear Idle Gear
500 88-89	-----	-----	-----	3274M
650/701 (all)	6M6-81800-10-00	S1095MHT	S1095M	3270M
760	64X-81800-00-00	S1105MHT	S1105M	3270M
800/1100/1200 (all)	63M-81800-00-00	S1099MHT	S1099M	3270M
FX140 (4 Stroke)	60E-81800-00-00	S1103MHT	S1103M	Not Required
VX110	6D3-81800-00	S1107MHT	S1107M	-----

Honda	OEM#	High Torque Starter	OEM Replacement Starter	Drive Gear Idle Gear
F12/F12X 1200cc Aqua Trax	31200-HW1-671	-----	S1101M	Not Required

Tigershark	OEM#	High Torque Starter	OEM Replacement Starter	Drive Gear Idle Gear
640/650/770/900/1000 (92-99)	3008/093/327/536	S1097MHT	-----	3270M



S1094MHT
S1094M



S1092MHT
S1092M



S1100M



S1093MHT
S1093M

Kawasaki	OEM#	High Torque Starter	OEM Replacement Starter	Drive Gear Idle Gear
440/550/550SX (all)	21163-3710	S1094MHT	S1094M	3273M
650/750/800/900/1100 (all)	21163-3712	S1092MHT	S1092M	3270M
ULTRA150, STX-R	21163-3715	-----	S1100M	Not Required
12F, 15F	2163-3720/2163-372	S1108MHT	S1108M	Not Required

Polaris	OEM#	High Torque Starter	OEM Replacement Starter	Drive Gear Idle Gear
650/750/785/900/1050 (all)	324-01100	S1093MHT	S1093M	3270M



3270M
(19 tooth)



3273M
(9 tooth)



3274M
(11 tooth)



3275M
9 Tooth
(OEM 9 Tooth)



3276M
8 Tooth
(High Torque Unit)

Manufacturer's Warranty Policy: All MES products (excluding MES Economy Starters), when properly installed, are warranted by MES against defects in materials and workmanship for a period of one year from the date of sale to the original purchaser. For MES to accurately inspect defective items for warranty consideration, we ask that all returns reach our facility within the warranty period with an RA#, along with a copy of the original invoice and a brief explanation of the product's alleged malfunction.

Non-Covered Warranty Issues: Our warranty is limited to the replacement of defective units only and does not cover labor or any other expenses. This warranty extends to the application under normal use, and does not apply to any of the following: submersion, deliberate abuse, broken drive-gears, that are broken or tampered with during installation, or involved in attempted improper installations. Any tampering or dismantling, grinding, drilling, removing or addition of parts, or any action that alters the original design of the unit, will immediately render this warranty null and void.

MES ECONOMY STARTERS



Sea-Doo Model	OEM#	Economy Starter	Drive Gear/Idle Gear
GT, SP, XP580 89-91	278-000-316	C1090-NA	3275M/3276M
SP, SPL, SPX580 91-94	278-000-316	C1090-NA	3275M/3276M
XP650 91-94(all)	278-000-316	C1090-NA	3275M/3276M
580/650/720 94-00(all)	278-000-485	C1091-NA	3275M/3276M
XP800 95, XP/GSX/GTX96	278-000-577	C1096-9-NA	3275M/3276M
951(all)	278-000-98Z	C1098-NA	3270M
4 Tec (4 Stroke)	290-888-999	C1102-NA	Not Required
97-2003 GSX, SPX, GTX RFI,	278-001-497/278-001-038	C1096-8-NA	Not Required
GSX RFI & 2003 GTI RFI	278-001-301		



Yamaha Model	OEM#	Economy Starter	Drive Gear/Idle Gear
650/701 (all)	6M6-81800-10-00	C1095-NA	3270M
800/1100/1200 (all)	63M-81800-00-00	C1099-NA	3270M

Tigershark Model	OEM#	Economy Starter	Drive Gear/Idle Gear
640/650/770/900/1000 (92-99)	3008/093/327/536	C1097-NA	3270M



Kawasaki Model	OEM#	Economy Starter	Drive Gear/Idle Gear
650/750/800/900/1100 (all)	21163-3712	C1092-NA	3270M
ULTRA150, STX-R	21163-3715	C1100-NA	Not Required

Manufacturer's Warranty Policy: All MES Economy Starters, when properly installed, are warranted by MES against defects in materials and workmanship for a period of 90 days from the date of sale to the original purchaser. For MES to accurately inspect defective items for warranty consideration, we ask that all returns reach our facility within the warranty period with an RA#, along with a copy of the original invoice and a brief explanation of the product's alleged malfunction.

Non-Covered Warranty Issues: Our warranty is limited to the replacement of defective units only and does not cover labor or any other expenses. This warranty extends to the application under normal use, and does not apply to any of the following: submersion, deliberate abuse, broken drive-gears, that are broken or tampered with during installation, or involved in attempted improper installations. Any tampering or dismantling, grinding, drilling, removing or addition of parts, or any action that alters the original design of the unit, will immediately render this warranty null and void.

FOUR STROKE
INTAKE SYSTEMS
ENGINE/GASKETS
EXHAUST
DRIVE LINE HANDLING
ELECTRICAL
WATERLINE /BILGE
STEERING & CONTROLS
BODY
ACCESSORIES
SERVICE TOOLS /HARDWARE
CHEMICAL

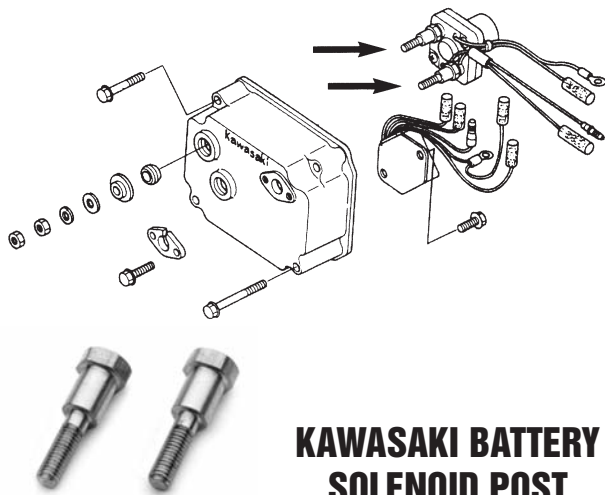

KAWASAKI BATTERY SOLENOID POST

Our solenoid post allows placement of corroded post without replacing the expensive solenoid on all Kawasaki Jet Ski with small electrical box.

Description	Part No.
Solenoid Post (2 per set)	55-3350



KAWASAKI ELECTRICAL BOX REPAIR FITTING

One kit contains 5 each of the nylon fittings, o-rings and black caps. These fittings will work on all Kawasaki watercraft electrical boxes and trim units.

Description	Part No.
Electrical Box Repair Fittings (5 sets per pack)	55-3400



PROTORQUE STARTERS



PH100-SD01

PH100-SD02

PH100-SD03

PH100-SD04

PH100-SD05

Sea-Doo Model	OEM#	Gold High Torque Version	OEM Equivalent Version	Drive Gear Idle Gear
GT, SP, XP580 89-91	278-000-316	PH100-SD01-G	PH100-SD01	-
SP, SPL, SPX580 91-94	278-000-316	PH100-SD01-G	PH100-SD01	-
XP650 91-94(all)	278-000-316	PH100-SD01-G	PH100-SD01	-
580/650/720 94-00(all)	278-000-485	PH100-SD02-G	PH100-SD02	-
XP800 95, XP/GSX/GTX96	278-000-577	PH100-SD04-G	PH100-SD04	-
951(all)	278-000-98Z	PH100-SD05-G	PH100-SD05	PH105-D001-G
97-2003 GSX, SPX, GTX RFI, GSX RFI & 2003 GTI RFI	278-001-497/278-001-038 278-001-301	PH100-SD03-G	PH100-SD03	Not Required
4-Tec (4 Stroke) All	420888995/420888996	PH100-SD06-G	PH100-SD06	PH105-D007



PH100-YA01 (Yamaha)



PH100-YA02 (Yamaha)



PH100-KW01 (Kawasaki)

Yamaha				
650/701 (all)	6M6-81800-10-00	PH100-YA01-G	PH100-YA01	PH105-D001-G
800/1100/1200/1300 (all)	63M-81800-00-00	PH100-YA02-G	PH100-YA02	PH105-D001-G
FX 140 (4 Stroke)	60E-81800-00-00	PH100-YA03-G	PH100-YA03	Not Required
760 (all)	64X-81800-00-00	PH100-YA04-G	PH100-YA04	PH105-D001-G
500 (all)	6K8-81800-10-00	PH100-YA05-G	PH100-YA05	PH105-D001-G
VX110 (4 Stroke)	6D3-81800-00-00	PH100-YA06-G	PH100-YA06	Not Required
FX SHO, FZR, FZS, VXR	6S5-81800-00-00	PH100-YA07-G	PH100-YA07	Not Required
VXS (4 Stroke)				
Kawasaki				
650/750/800/900/1100 (all)	21163-3712	PH100-KW01-G	PH100-KW01	PH105-D001-G
440/550	21163-3003, 21163-3710, 21163-3711	PH100-KW02-G	PH100-KW02	Not Required
Ultra 150, STX-R	21163-3715, 21163-3718	PH100-KW03-G	PH100-KW03	Not Required
STX, STX-12F, STX-15F	21163-3720, 21163-3721	PH100-KW04-G	PH100-KW04	Not Required
Ultra 250/260/300, Ultra LX				



PROTORQUE STARTER DRIVE FOR SEA-DOO, YAMAHA, KAWASAKI, POLARIS

Description	Part No.
Protorque Starter Drive	PH105-D001-G



PROTORQUE STARTER DRIVE FOR SEA-DOO 4-TEC (2002-2015)

Description	Part No.
Protorque Starter Drive for Sea-Doo 4-Tec	PH105-D007



WSM SEA-DOO 4-TEC OEM REPLACEMENT DOUBLE STARTER GEAR

Description	Part No.
Sea-Doo 4-Tec Double Starter Gear	004-360



WATCON WATERPROOF RELAY

This is a direct replacement for the Polaris watercraft & Weber / HSR starter relay. No modifications are required. It also works excellent in all "total loss" ignition systems or anything requiring a durable 12V starter relay.

This waterproof start relay might save you some troubleshooting, especially in an extremely wet or salt-water environment.

Used with SRPT-1 wiring connector.

Description	Part No.
Watcon Waterproof Relay	WPR1
Watcon Wiring Connector	SRPT-1

BATTERY CHARGERS

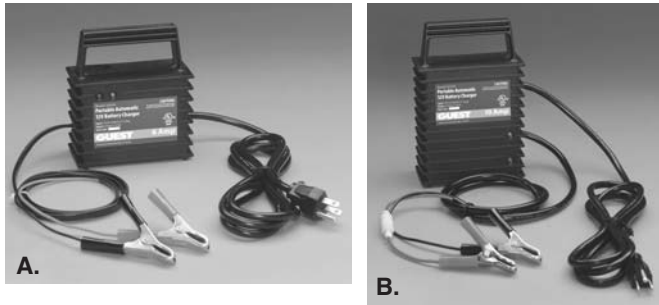

Description	Part No.
A. Portable Battery Charger - 12 volt, 6 amps	CU2606A
B. Portable Battery Charger - 12 volt, 10 amps	CU2612A



BLOWSION HEAVY DUTY BATTERY BOX STRAP

Blowson Heavy Duty Freeride Battery Strap. Much stronger and slightly shorter than OEM Yamaha straps which takes away the slack when using aftermarket batteries.

Description	Part No.
Battery Box Strap - Heavy Duty	01-04-604

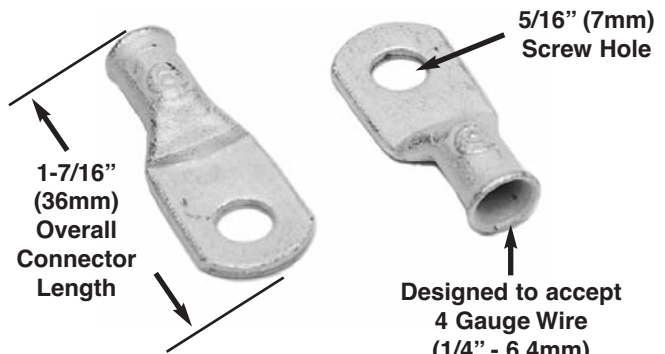

QUALITY BATTERY (LUGS) CONNECTION

Marine Grade™ lugs are manufactured from heavy duty annealed tinned copper, providing for maximum current flow. 100% tin plated copper resists corrosion from salt and moisture. Seamless barrel design allows for maximum strength when crimped. Closed end design seals out moisture so cables stay dry and corrosion free.

Description	Part No.
Battery Cable Ends (2pcs/set)	55-2031



12 VOLT DC BATTERY TESTER

The 12 volt DC automotive tester quickly indicates alternator output and status of battery charge. The tester features a durable case with a magnetic strip on the back that adheres to any steel surface for safe operation. Features LED lights that show normal, low or flat level of battery charge.

Description	Part No.
12 Volt DC Battery Tester	991085

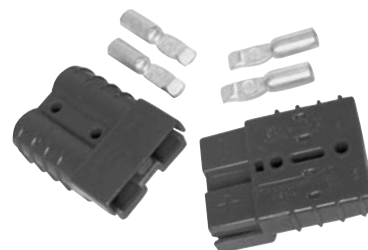

MSD BATTERY QUICK DISCONNECT

Racers will appreciate this Quick Disconnect Battery Connector because it allows for easy removal of the battery. The connectors grip together to form a vibration proof connection but can easily be disconnected for quick removal for charging of the battery.

Description	Part No.
Battery Quick Disconnect	4376



JUMPER CABLES

8 feet long heavy duty 8 gauge copper jumper cables are big on charging power, yet stow conveniently in the 9 x 9 inch nylon bag.

Description	Part No.
Jumper Cables	59-0530

FOUR STROKE	INTAKE SYSTEMS	ENGINE/GASKETS	EXHAUST	DRIVE LINE HANDLING	ELECTRICAL	WATERLINE /BILGE	STEERING & CONTROLS	BODY	ACCESSORIES	SERVICE TOOLS /HARDWARE	CHEMICAL
-------------	----------------	----------------	---------	---------------------	------------	------------------	---------------------	------	-------------	-------------------------	----------

WSM REPLACEMENT STARTER RELAYS



004-120



004-132



004-120-02

Fits Year O.E. No. Part No.

KAWASAKI

650 SX	87-91	27010-3705	004-130
650 X2	1991		
750 ZXi	95-97	27010-3737	004-131
900 STX	97-98		
900 ZXi	95-97		
1100 STX	97-98		
1100 ZXi	96-03		
550	92-95	27010-3760	004-132
750 SXi Pro	99-02		
750 Xi Sport	98-99		
800 SX-R	03-06		
900 STS	01-02		
900 STX	99-06		
1100 STX	1999		
1200 Ultra 150	99-05	27010-3757	004-134
1200 STX-12F	03-07	27002-3703	004-133
1500 STX	09-10	27002-3702	
1500 STX-15F	04-13		
1500 Ultra 250X	2008		
1500 Ultra 260 LX	2009		
1500 Ultra 260 LX SC	2010		
1500 Ultra 260 X	2009		
1500 Ultra 260 X SC	2010		
1500 Ultra 300 LX	11-13		
1500 Ultra 300 X	11-13		
1500 Ultra LX	07-13		



004-133

SEA-DOO

All Models	88-94	278000342	004-120
Without Update Kit			
All RFI & DI Models		278000513	004-120-01
All 2 Stroke	95+	278001802	004-120-02
Excludes RFI & DI Models			
All 4-Stroke		278002347	
External Mount			

YAMAHA

All	87-01	6G1-81941-10	004-124
SJ 700	02-08	68N-81940-00	004-125
XL 700	02-04		
GP 800	02-05		
XLT 800	02-04		
GP 1200	2002		
SUV 1200	2003		
SV 1200	02, 04		
XLT 1200	02-05		
GP 1300	03-08		
FX 1000	2004		
FX 140	02-04		
FX Cruiser	2003		
FX 1100	04-08	686-81940-00	004-126
FX H.O.	05-08		
VX 1100	05-08		



004-125

WSM REPLACEMENT CDI BOXES

Fits Year O.E. No. Part No.

SEA-DOO

580 GTS	95-96	278000474	004-220-01
580 SP	1995	278001134	
580 SPI	1995	278000423	
650 GTX	1995		
650 SPX	1995		
720 HX	1995		
720 XP	1995		
Same as above, but with adjustable rev. limiter			004-220-02
720 GS	97-01	278001496	004-220-03
720 GSI	1997	278000916	
720 GTI	97-02		
720 GTI LE	2002		
720 GTS	97, 01		
Same as above, but with adjustable rev. limiter			004-220-04
800 GSX	1997	278001031	004-220-08
High Performance		278000510	
800 GSX	1996	278000897	004-220-13
800 GTX	1996	278000510	
800 XP	96-97		
800 GTX	1997		004-220-11
800 SPX	97-99		
800 XP	1997	278001079	004-220-06
Fully Programmable			
800 XP	1997		004-220-10
For Damaged Wire Harness			
800 XP	1998	278001342	004-220-07
Fully Programmable			
720 SP	1997	278001255	004-220-05
800 SPX	97-99	278001202	
		278000981	
Box Fully Programmable			
Security Key Programmability			
Timing & Rev Limiter Programmability			
951 GSX Ltd.		278000926	004-220-09
		295500790	
951 XP	1998		004-220-12



004-220-02



004-220-04



004-220-08



004-220-10



004-220-12



004-212-01



WSM REPLACEMENT COILS



004-155



004-153



004-240



004-156



004-242



004-241

YAMAHA LIGHTING COILS

Yamaha	OEM No.	Year	CC	Model	Part No.		
Lighting Coil	6K8-81303-40-00	1989-1990	500	Wave Jammer	004-152		
	6E7-81303-40-00	1989-1993	500	Wave Runner			
Lighting Coil	6M6-85533-00-00	1990-1993	650	SuperJet	004-156		
		1991-1995	650	VXR			
		1990-1995	650	Wave Runner III			
		1991-1993	650	Wave Runner LX			
		1991-1995	700	FX1			
		1995	700	SuperJet			
		1993-1994	700	VXR Pro			
		1993-1995	700	Wave Blaster			
		1994-1995	700	Wave Runner III			
Lighting Coil		62T-85533-00-00	1996	650		Wave Runner III	004-147
			1996-2009	700		SuperJet	
			1996	700		Wave Blaster	
	1994-1997		700	Wave Raider			
	1997		700	Wave Runner III			
	1995-1998		700	Wave Venture			
	1999-2004		700	XL			
	1999-2000		760	GP			
	1996-1997		760	Wave Blaster			
	1996		760	Wave Raider			
	1997-1998		760	Wave Runner			
	1997		760	Wave Venture			
	1998-1999	760	XL				

YAMAHA CHARGE COILS

Yamaha	OEM No.	Year	CC	Model	Part No.			
Charge Coil	6M6-85520-00-00	1990-1993	650	SuperJet	004-155			
		1991-1995	650	VXR				
		1990-1995	650	Wave Runner III				
		1991-1993	650	Wave Runner LX				
		1994-1995	700	FX1				
		1995	700	SuperJet				
		1993-1994	700	VXR Pro				
		1993-1995	700	Wave Blaster				
		1994-1995	700	Wave Runner III				
Charge Coil		62T-85520-00-00	1996	650		Wave Runner III	004-148	
Charge Coil			62T-85520-01-00	1996-2009		700		SuperJet
				1996		700		Wave Blaster
	1994-1997			700	Wave Raider			
	1997			700	Wave Runner III			
	1995-1998	700	Wave Venture					
	1999-2004	700	XL					
Charge Coil	64X-85520-00-00	1999	760	GP	004-146			
		1996-1997	760	Wave Blaster				
		1996	760	Wave Raider				
		1997-1998	760	Wave Runner				
		1997	760	Wave Venture				
		1998-1999	760	XL				

YAMAHA PULSER COILS

Yamaha	OEM No.	Year	CC	Model	Part No.
Pulser Coil	6M6-85580-00-00	1990-1993	650	SuperJet	004-153
		1991-1995	650	VXR	
		1990-1996	650	Wave Runner III	
		1991-1993	650	Wave Runner LX	
		1994-1995	700	FX1	
		1995-1999	700	Super Jet	
		1993-1994	700	VXR Pro	
		1993-1996	700	Wave Blaster	
		1994-1997	700	Wave Raider	
		1994-1997	700	Wave Runner III	
		1995-1998	700	Wave Venture	
		1999	700	XL	

YAMAHA STATOR PLATES

Yamaha	OEM No.	Year	CC	Model	Part No.
Stator Plate	6R7-85560-00-00	1990-1995	650	SuperJet	004-242
Assembly	6R8-85560-00-00 (smaller Coils)	1991-1995	650	VXR	
		1990-1995	650	Wave Runner III	
		1994-1995	700	FX1	
		1993-1994	700	VXR Pro	
		1993-1995	700	Wave Blaster	
		1994-1995	700	Wave Runner III	
Stator Plate		62T-85560-00-00	1996	650	
Assembly	6R7-85560-10-00 (bigger Coils)	1996-2009	700	SuperJet	
		1996	700	Wave Blaster	
		1994-1997	700	Wave Raider	
		1997	700	Wave Runner III	
		1995-1998	700	Wave Venture	
		1999-2003	700	XL	

YAMAHA ARMATURE COIL

Yamaha	OEM No.	Year	CC	Model	Part No.
Armature Coil	65U-85510-00-00	1997-1999	1200	GP	004-241
		1999	1200	SUV	
		1998	1200	XL	



004-162



004-163

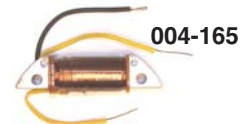

004-165



004-166

KAWASAKI CHARGE COILS

Kawasaki	OEM No.	Year	CC	Model	Part No.
Charge Coil	59031-3002	1983-1992	440	JS	004-161
		1982-1989	550	JS	
		1990-1995	550	SX	
Charge Coil	21003-3719	1991-1995	650	SC	004-165
		1989-1990	650	TS	

KAWASAKI EXCITER COILS

Kawasaki	OEM No.	Year	CC	Model	Part No.
Exciter Coil	21049-3007	1983-1992	440	JS	004-162
		1982-1989	550	JS	
		1990-1995	550	SX	
Exciter Coil	21003-3719	1991-1995	650	SC	004-166
		1989-1990	650	TS	

KAWASAKI PULSER COILS

Kawasaki	OEM No.	Year	CC	Model	Part No.
Pulser Coil	59026-3008	1983-1992	440	JS	004-163
		1982-1989	550	JS	
		1990-1995	550	SX	

FOUR STROKE
INTAKE SYSTEMS
ENGINE/GASKETS
EXHAUST
DRIVE LINE HANDLING
ELECTRICAL
WATERLINE/BILGE
STEERING & CONTROLS
BODY
ACCESSORIES
SERVICE TOOLS
CHEMICAL



WSM REPLACEMENT COILS



004-200

SEA-DOO CHARGE COILS

Sea-Doo	OEM No.	Year	CC	Model	Part No.	
Armature	290886588	1997	720	SP	004-200	
Coil	420886588	1996-1997	800	GSX		
		1996-1997	800	GTX		
		1997-1999	800	SPX		
		1995-1997	800	XP		
		1998-1999	951	GSX		
		1998-2002	951	GTX		
		2000-2001	951	LRV		
		2000-2002	951	RX		
		2001	951	RX X		
		2000-2002	951	XP		
		1998-1999	951	XP LTD		
Armature	290887950	2005	800	3D RFI	004-201	
Coil	420887951	1999-2000	800	GSX RFI		
		2003-2005	800	GTI RFI		
		1998-2002	800	GTX RFI		
Armature	420888652	2000	951	GTX DI	004-201-01	
Coil	290888652	2001	951	GTX DI		
	290888651	2002	951	GTX DI		
	290888650	2003	951	GTX DI		
		2002	951	LRV DI		
		2003	951	LRV DI		
		2000	951	RX DI		
		2001	951	RX DI		
		2002	951	RX DI		
		2003	951	RX DI		
		2003	951	XP DI		
Armature	420888656	2006	951	3D DI		004-201-02
Coil		2007	951	3D DI		
		2004	951	XP DI		
Armature	420889720	2005	1503	Challenger Super Charged 215	004-203-01	
Coil	290889720			Challenger Super Charged 215		
		2006	1503	Challenger Super Charged 215		
		2002	1503	GTX		
		2003	1503	GTX		
		2004	1503	GTX		
		2005	1503	GTX		
		2003	1503	GTX LTD Super Charged 185		
		2004	1503	GTX LTD Super Charged 185		
		2005	1503	GTX LTD Super Charged 215		
		2003	1503	GTX Super Charged 185		
		2004	1503	GTX Super Charged 185		
		2005	1503	GTX Super Charged 185		
		2003	1503	GTX Wake		
		2004	1503	GTX Wake		
		2005	1503	GTX Wake		
		2004	1503	RXP Super Charged 215		
		2005	1503	RXP Super Charged 215		
		2005	1503	RXT Super Charged 215		
		2005	1503	Speedster 155		
		2006	1503	Speedster 155		
		2005	1503	Sportster 155		
		2006	1503	Sportster 155		
		2006	1503	Utopia / SE 155		



004-170



004-171

SEA-DOO CHARGE COILS

Sea-Doo	OEM No.	Year	CC	Model	Part No.
Charge Coil	290-866-635	1990-1991	580	GT	004-170
	410-912-000	1989-1991	580	SP	
		1991-1994	580	XP	
		1994	580	XPI	
Charge Coil	290-965-400	1992-1995	580	GTS	004-171
	410-915-200	1992-1993	580	GTX	
		1992-1996	580	SP	
		1993-1996	580	SPI	
		1993	580	SPX	
		1992	580	XP	
		1995	650	GTX	
		1994-1995	650	SPX	
		1997-2001	720	G	
		1997	720	GSI	
		1996-2005	720	GTI	
		2002-2004	720	GTI LE	
		1996-2001	720	GTS	
		1995-1997	720	HX	
	1997	720	SP		
	1996-1997	720	SPX		
	1995	720	XP		

SEA-DOO STATOR ASSEMBLY

Sea-Doo	OEM No.	Year	CC	Model	Part No.
Stator Assembly	290-886-726	1995-1997	580	GTS	004-202
	420-886-725	1995	580	SPI	
		1995	650	GTX	
		1995	650	SP	
		1995	650	SPX	
		1995	650	XP	
		1997	720	GS	
		1997	720	GSI	
		1996-2005	720	GTI	
		1995-1997	720	HX	
		1996-1997	720	SP	
		1996	720	SPI	
		1996-1997	720	SPX	



004-202



SEA-DOO COOLANT TEMPERATURE SENSOR

Description	Part No.
Fits all Sea-Doo 4-Tec (2002-07)	004-277



YAMAHA GENUINE OEM STATOR ASSEMBLY

Description	Part No.
Genuine OEM Yamaha 701 (62T) Stator Assembly	62T-85560-00-00



004-175



004-157

IGNITION COILS
OEM Replacement

Sea-Doo	OEM No.	Year	CC	Model	Part No.
Ignition Coil	290-866-607	1989-1990	580	SP	004-175
Ignition Coil	278-000-202	1992-1996	580	GTS	004-178
Ignition Coil	278-000-586	1992-1993	580	GTX	004-178
		1992-1996	580	SP	
		1993-1996	580	SPI	
		1992	580	XP	
		1994-1995	650	GTX 3	
		1993-1995	650	SPX	
		1994-1995	650	XP	
		1994	650	XPI	
		1996-1997	720	GTI	
		1997-2000	720	GTS	
		1995-1997	720	HX	
		1997	720	SP	
		1996-1997	720	SPX	
Ignition Coil	278-000-383	2001-2005	720	GTI	004-176
		2002-2004	720	GTI LE	
		2001	720	GTS	
		1997	720	SP	
		1996-1997	800	GSX	
		1996-1997	800	GTX	
		1997-1999	800	SPX	
		1995-1996	800	XP	
		1998	951	GTXLTD	

Yamaha	OEM No.	Year	CC	Model	Part No.
Ignition Coil	6K8-85570-10-00	1989-1990	500	Wave Jammer	004-150
Ignition Coil	6K8-85570-19-00	1989-1993	500	Wave Runner	004-150
Ignition Coil	6M6-85570-00-00	1991	650	Super Jet	004-157
Ignition Coil	6R8-85570-00-00	1990-1993	650	Wave Runner III	004-157
Ignition Coil	62E-85570-00-00	1991	650	Wave Runner LX	004-157
Ignition Coil	62E-85570-10-00	1999-2009	700	Super Jet	004-157
Ignition Coil	62E-85570-11-00	1993-1996	700	Wave Blaster	004-157
		1994-1995	700	Wave Raider	
		1994-1997	700	Wave Raider	
		1994	700	Wave Runner III	
		1995-1996	700	Wave Venture	
Ignition Coil	64X-85570-00-00	1999-2000	760	GP	004-196
Ignition Coil	64X-85570-01-00	1996-1997	760	Wave Raider	004-196
		1997-1999	760	Wave Runner XL	
		1996-1997	760	Wave Venture	
		1998-2005	800	GP	
		2004	800	Wave Runner XA	
		2000-2001	800	Wave Runner XL	
		2002-2003	800	Wave Runner XLT	
Ignition Coil	63M-85570-00-00	1995-1996	1100	Wave Raider	004-193
		1996-1997	1100	Wave Venture	

Kawasaki	OEM No.	Year	CC	Model	Part No.
Ignition coil/CDI Box	21119-3703	1987-1991	650	SX	004-208
	21119-3711				
Ignition Coil	21121-3702	1992-1995	750	SX	004-157
Ignition Coil	21121-3705	1995-2002	750	SXI	004-157
Ignition Coil	21121-3712				004-157
Ignition Coil Cyl. #1 (15" Long Wire)	21121-3708	2001-2002	900	STS	004-192-15
		1997-2006	900	STX	
		1995-1997	900	ZXI	
		1997-1999	1100	STX	
		1996-2003	1100	ZXI	
		Ignition coil Cyl. #2 (21" Long Wire)	21121-3709	2001-2002	
		1997-2006	900	STX	
		1995-1997	900	ZXI	
		1997-1999	1100	STX	
		1996-2003	1100	ZXI	
Ignition coil Cyl. #3 (26" Long Wire)	21121-3710	2001-2002	900	STS	004-192-26
		1997-2006	900	STX	
		1995-1997	900	ZXI	
		1997-1999	1100	STX	
		1996-2003	1100	ZXI	



004-115



004-114



004-116



004-117

START/STOP SWITCH
OEM Replacement

Sea-Doo	OEM No.	Year	Model	Part No.
Start/Stop Switch	204390230	2002	GTX RFI 800	004-115
	278001405	2000-01	LRV 951	
		2002	RX 951	
Start/Stop Switch	278001733	1999	XP Limited 951	004-114
		2006-07	GTI All Models	
		2002-07	GTX 4-Tec All Models	
		2004-07	RXP	
Start/Stop Switch	278000427	2005-07	RXT	004-116
		1995-97	HX	
		1996-98	GSX	
		1997-99	GTS	
		1996-98	GTX	
		1995-97	SP	
		1995-96	SPI	
		1995-97	SPX	
		1995-96	XP	
		Start/Stop Switch	278001115	
1997	GSI 720			
1997-98	GTI 720			
1997	GTS 720			
1997	GTX 800			



RUBBER SWITCH BUTTON
OEM Replacement

Sea-Doo	OEM No.	Year	Model	Part No.
Rubber Switch Button	277000306	2000-01	GS	004-101
		2000-05	GTI	
		2002-04	GTI LE	
		2001	GTS	
		2005	3D RFI	
		1999-2000	GSX RFI	
		2003-05	GTI LE RFI	
		1999-2002	GTX RFI	
		2006-07	3D DI	
		2000-02	GTX	
		2000-01	GTX DI	
		1999	GTX LTD	
		2000-01	LRV	
		2002	LRV DI	
		2000-02	RX	
2000-03	RX DI			
2000-02	XP			
2003-04	XP DI			
1999	XP LTD			
2008	RXP & RXT 255			

FOUR STROKE
INTAKE SYSTEMS
ENGINE/GASKETS
EXHAUST
DRIVE LINE HANDLING
ELECTRICAL
WATERLINE /BILGE
STEERING & CONTROLS
BODY
ACCESSORIES
SERVICE TOOLS
HARDWARE
CHEMICAL

NO MORE SEARCHING REQUIRED! HOT PRODUCTS HAS THE SWITCH FOR YOUR APPLICATION

Hot Products PWC Waterproof Switches Imported Exclusively from



57-3020

**HOT PRODUCTS
EXCLUSIVE**



JP7043 can be installed with Hot Products Throttle Lever 58-0970 & 58-0971 as pictured above.

3-POSITION PANEL MOUNT ROTARY SWITCH

Connects to two electronic accessories for power control. Allows the operation of one device or accessory to run at a time. Suggested uses: Second Bilge, Ignition, etc. 12Volt/5Amp.



**Left Hand
On Position**
Use: Blue &
Red Wires



**Center Off
Position**



**Right Hand
On Position**
Use: White &
Red Wires

Description	Part No.
Panel Mount Switch	57-3020

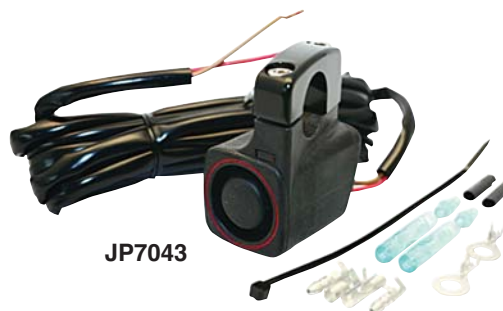

JP7043

UNIVERSAL HANDLEBAR MOUNT SWITCHES

Mounts to handlebar or mounts to underside of most aftermarket throttle levers. Complete with 9" wire lead.

Description	Part No.
Handlebar Mount Switch 12Volt/6Amp push on/off switch	JP7043



KAWASAKI JET SKI LANYARD AND SWITCH

This factory Kawasaki switch allows you to use a safety lanyard. On all year Kawasaki JS440/JS550/550SX/750SX/750SXI/800SXR. Easy and quick to install, usually takes less than 5 minutes. Replaces your original switch face plate to allow for use of a lanyard. Factory Kawasaki part, so you know it's the highest quality and will last!

Description	Part No.
Switch with Lanyard - Neon Green	AZ1030NG

*Please call for custom color lanyard special order



YAMAHA SUPERJET LANYARD AND SWITCH

This part is a Genuine OEM Yamaha Start/Stop Switch assembly. Includes OEM Lanyard. Fits all Yamaha Standup Models.

Description	Part No.
Switch with Lanyard - Red	EW2-68310-04-00

FOUR STROKE
INTAKE SYSTEMS
ENGINE/GASKETS
EXHAUST
DRIVE LINE HANDLING
ELECTRICAL
WATERLINE /BILGE
STEERING & CONTROLS
BODY
ACCESSORIES
SERVICE TOOLS /HARDWARE
CHEMICAL

WATERPROOF SWITCHES AND BRACKETS

- Features waterproof on/off switch that is available with machined aluminum clamp-on or switch mounted bracket. Allows totally reliable and easy control of bilge pump operation.
- Mounting bracket is machined from billet alloy and is anodized black to prevent corrosion. Available for clamp-on bar mounting or bolts to the bottom of the OEM on/off switch assembly.
- All of the switches have a 9 foot high grade wire lead.

UNIVERSAL



Yamaha
All

Part No.
57-3017



Description
Universal Handle Bar Mount

Part No.
57-3006



Kawasaki
All 650 / 750SS-95 / XI-93

Part No.
57-3015



Kawasaki
440 / 550 / 750SX /
750SXI / 800SX-R

Part No.
57-3003

Description
Standard Switch with
9 feet of wire (No bracket included)

Part No.
57-3009



CPI WATERPROOF SWITCH ONLY

This replacement safety switch fits Sea-Doo's and other manufacturers.

Description
Replacement Safety Switch
(Sea-Doo & other manufacturers)

Part No.
57-3011



UMI RXP TRIM/SWITCH HOUSING

UMI's trim/switch housing is machined from 6061-T6 billet aluminum, replacing the stock plastic housing. Trim/switch housing uses the factory variable trim switch and start/stop switch. This housing must be used with the UMI GSX/RXP (P/#58-6321) steering system, aftermarket bars and finger throttle.

Description
UMI RXP Trim/Switch Housing

Part No.
SD-01600-CLR



BILLET 3 SWITCH HOLDER For Aftermarket Handlebar

Description
Sea-Doo

Color
Polished

Part No.
58-2004

2015 HOT PRODUCTS
IJSBA MARK HAHN
MEMORIAL HAVASU 300
ENDURANCE RACE, IN LAKE
HAVASU CITY, ARIZONA.



FOUR STROKE
INTAKE SYSTEMS
ENGINE/GASKETS
EXHAUST
DRIVE LINE HANDLING
ELECTRICAL
WATERLINE /BILGE
STEERING & CONTROLS
BODY
ACCESSORIES
SERVICE TOOLS /HARDWARE
CHEMICAL

NGK SPARK PLUGS



STANDARD PLUGS*

- B7ES
- B7HS
- B8ES
- B8HS
- B9ES

*Sold 10 per Box



*(Terminal can be removed)

RESISTOR PLUGS*

- BPR7ES
- BR7ES
- BR7HS
- BPR8ES
- BPR9ES
- BR8ES
- BR8HS
- BR9ES
- BR9HS

*Sold 10 per Box

SOLID RESISTOR PLUGS**

- BR8ES-SOLID
- BR8HS-SOLID
- BR9ES-SOLID
- BR8ES-11
- (For Yam GPR)
- CR9EB

*Sold 10 per Box

**Solid Terminal
(Non separable)



Find the NGK Spark Plug for your application using the NGK Spark Plug Finder



NGK SPECIAL SPARK PLUGS FOR FOUR STROKE ENGINES

Description	Part No.
Sea-Doo GTX-4tec RXP/RXT/RXP-X/RXT-X (10 per Box)	DCPR-8E
Sea-Doo GTX-DI, LRV-DI, RX-DI (4 per Box)	ZFR4F-11
Sea-Doo Spark (10 per Box)	CR8EB
Kawasaki K1100 STX-DI, Ultra 130 DI (4 per Box)	PZFR7G-G
Kawasaki Ultra 150 A-1 (10 per Box)	R6918C-9
Kawasaki Ultra 150 A-2-3 (10 per Box)	BR9ES
Kawasaki STX 12F/15F (10 per Box)	CR9EK
Kawasaki Ultra 250/260/300 (4 per Box)	PMR9B
Yamaha FX 140/160, VX110 (10 per Box)	CR9EB
Yamaha FX SHO, FZR, FZS (10 per Box)	LFR6A
Yamaha FX SVHO (10 per Box)	LF7A
Polaris M140, Genesis (4 per Box)	PZFR6H
Hydrospace S4 (4 per Box)	BKR7EIX-11
Honda 4 Stroke (4 per Box)	IMR9D-9H

Looking for spark plugs not listed?
Hot Products can special order spark plugs for any application, contact us for details, info and pricing.



NGK IRIIDIUM IX SPARK PLUGS

Iridium is significantly stronger than any metal used in spark plugs today. The ignitability and durability is better than platinum. Sold 4 per box.

IRIDIUM IX PLUGS

- BR8EIX
- BR9EIX
- BR8HIX
- CR9EIX
- BKR7EIX-11
- BPR8EIX
- BPR9EIX
- DCPR8EIX
- LF7AIX

*All NGK Iridium Spark Plugs are 4 per package.
*Iridium plugs are gapped at NGK, if you try to gap the plugs you will damage the center electrode.



NIPPON DENSO IRIIDIUM SPARK PLUGS

Description	Part No.
Sea-Doo GTX-4tec, RXP/RXT/RXP-X/RXT-X	IXU24
Sea-Doo GTX-DI, LRV-DI, RX-DI	IK-16
Kawasaki Ultra 250/260/300	IU27
Kawasaki STX-12F/15F	IU27A
Yamaha FX-SHO, FZR, FZS	IKH-20

*All Nippon Denso Iridium Spark Plugs are 4 per package.
*Iridium plugs are gapped at Nippon Denso, if you try to gap the plugs you will damage the center electrode.

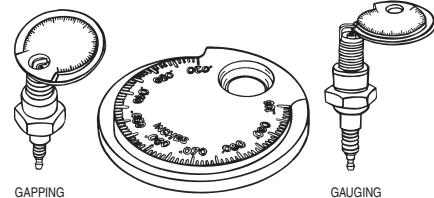

STANDARD/HIGH ENERGY SPARK PLUG GAUGE & GAPPER

Gauge and gap all types of spark plugs from .020" to .110 (.50mm to 2.53mm).

Description	Part No.
Spark Plug Gauge and Gapper	LS67870



O.D. | 17mm



A.



B.

O.D. | 19mm

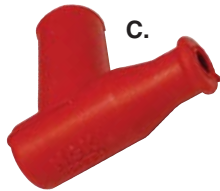

C.

O.D. | 17mm

NGK RESISTOR COVER

Resistor Covers May Be Required for Power Sport Applications When Spark Plugs Alone Don't Provide Sufficient Noise Suppression.

Highly Durable Phenolic Resin and EPDM Rubber Ceramic Resistors Ensure Optimum Performance and Reliability
Built to Withstand Extreme Heat and Vibration

Resistance: 5k ohm

Suitable ø Plug Thread: 14mm Wire

Suitable Terminal Type: Terminal Nut or Solid Post

Description	Part No.
A. Black	TB05EMA
B. Black with special waterproof cover	TB05EMD
C. Red	TB05EM-R



MARK GOMEZ COMPETING "VINTAGE SKI" CLASS AT THE 2015 IJSBA QUAKYSENSE WORLD FINALS IN LAKE HAVASU CITY, ARIZONA. PHOTO COURTESY OF JIN OMURA.



OPPAMA

OPPAMA PET-2100DXR TACHOMETER

This measures engine rpm, maximum rpm, total cumulative operating time, resettable cumulative operating time. This has a dual display system for either current rpm alone or current & maximum rpm, and also has two maximum rpm memories for comparison.

For 2 stroke engines 1 to 4 cylinder applications.

For 4 stroke engines 1 to 6 and 8 cylinder applications.

*This unit is not compatible with diesel engine and direct ignition applications.

Made in Japan.

Description	Part No.
PET-2100DXR Tachometer	PET-2100DXR



TINY DIGITAL TACHOMETER & HOURMETER

Tachometer and resettable Hourmeter powered by internal battery. Sealed for moisture resistance.

For 2 stroke engines 1 to 4 cylinder applications.

For 4 stroke engines 1 to 6 and 8 cylinder applications.

Description	Part No.
Standard Digital Tiny-Tach (2 & 3-Cylinder)*	59-0552

*Resettable hourmeter



COMMERCIAL TINY DIGITAL TACHOMETER & HOURMETER

Features all the same features as the Tiny Tach Part# 59-0552 (see above).

Additional features included on this model:

- High RPM Recall
- Two Service Timers
- Can be programmed for different engine applications

Description	Part No.
Commercial Digital Tiny-Tach	59-0558



HARDLINE PRODUCTS HOURMETER & TACHOMETER

Has same features as hour meter plus tachometer feature. Works on any gas engine up to 2 cylinders and 9000 RPM.

- Firing pattern 1 spark = 1 RPM
- Resolution 10 RPMs
- Maximum RPMs 9000
- Suitable for all single and twin, two or four cycle gasoline engines operating within specified tachometer firing pattern.

Description	Part No.
Hour/Tach Meter	HR-8061

FOUR STROKE
INTAKE SYSTEMS
ENGINE/GASKETS
EXHAUST
DRIVE LINE HANDLING
ELECTRICAL
WATERLINE /BILGE
STEERING & CONTROLS
BODY
ACCESSORIES
SERVICE TOOLS /HARDWARE
CHEMICAL

ATLANTIS PWC FLUSH KITS

SEA-DOO



Sea-Doo Part No.
SP (89-97), XP (91-96), **A7000**
GTS (92-00), SPX (93-94),
SPX (96-99), GTI (1996),
GTX 580 Engine (92-94),
SPI (93-94), SPI (96)



Sea-Doo Part No.
Fits All Sea-Doo **A7001**
Models 93-02 Non-Rear Drain
Pipe Flush Kit - Sea-Doo PWC
(All 93-02 Non-Rear Drain)



Sea-Doo Part No.
95-08 Short Version **A7004**
Sea-Doo with Rear Drain
Pipe, 95-97 Single Engine
Jet Boats.



Much easier to install than the OEM
flush kit. No drilling, only needs a
slotted screwdriver for installation.
Sea-Doo Part No.
Fits all Spark **A7011**

Quick Snap Type



Sea-Doo Part No.
96-15 Quick Snap **A7003**
Fits All with Rear Drain Pipe
and No Reverse Gear



Sea-Doo Part No.
95-08 Short Version **A7005**
Sea-Doo PWC with Rear
Drain Pipe, 96-97 Sea-Doo
Speedster, 96-98 Sea-Doo
Sportster, 2000 Sea-Doo



Sea-Doo Part No.
GTX (94-95), SPI (95) **A7009**
SPX (95)



Sea-Doo Part No.
Sea-Doo Replacement **A7010**
Flush Kit Fitting, Comes with
T Fitting, Quick Disconnect
Attachment and 2 Hose
Clamps. Fits SP (89-97), XP
(91-96), GTS (92-00), SPX
(93-94), SPX (96-99), GTI
(96), GTX 580 Engine (92-94),
SPI (93-94 & 96)

KAWASAKI



Kawasaki Part No.
JS440, JS550,
550SX (All Years)
**Can Be Used As A Universal
Flush Kit For All Skis With
3/8 Waterline**



Kawasaki Part No.
89-91 Jet Ski,
Ultra 150 **A2520**



Kawasaki Part No.
95-04 ZXI, STX,
Ultra 130 **A2522**



Kawasaki Part No.
03-10 4-Stroke **A2628**
Easy way to flush your new
Kawasaki jet ski, just screw
on the fitting and leave it.
Attach a quick-snap fitting to
the garden hose and you are
ready to flush.



Kawasaki Part No.
92-06 Jet Ski
Except ZXI/STX/Ultra 150 **A2521**



Kawasaki Part No.
11-15 Ultra 300/310 X, LX **A7005**
One Plug for Drain Flush
Another for Intercooler.

YAMAHA



Yamaha Part No.
95-10 Factory
Replacement **A8582**
GP760/1100/1200, Jet Boat
& 4 Stroke (FX,VX,FZ)



Yamaha Part No.
Wave Raider **A8584**



Yamaha Part No.
Super Jet (90-10), Raider 701 (94-95),
Blaster 701 (93-96), Wave Runner LX (91-93),
Venture 701 (95-96), Wave Runner III (92-97),
VXR & VXR Pro (92-95), FX1 (94-95)
Quick Disconnect Type of the Above Applications **A8588**



Yamaha Part No.
A8589



Polaris
90-04
(Except Direct Injection)

Part No.
A6000



Universal
Panel Mount
Universal Flush Kit

Part No.
A2515



Universal
Universal Flush
Kit with Water Line

Part No.
A2500XBL

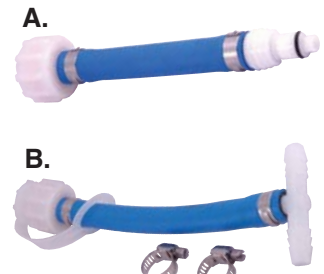

Universal
A. Male Quick Snap
Adapter Only for Replacement
B. Universal 3/8"

Part No.
A2690
A2505



ATLANTIS BACK FLUSH KIT

This product is in popular demand for those who typically run their watercraft in shallow surf and sediment

rich waters. Back flushing pushes the sand down and out through the pump utilizing the flow of water and gravity.

Description	Part No.
Single Back Flush Kit	A2691
Dual Back Flush Kit	A2692



SALT AWAY AND SALT TERMINATOR ENGINE FLUSH MIXER

Description	Part No.
Salt Away and Salt Terminator Mixer Only*	SX-M

**Hot Products does not sell Salt Away or Salt Terminator liquid product, only the mixer.*

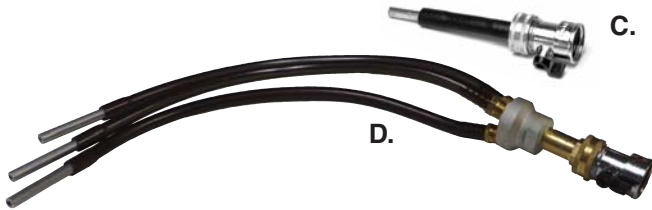

BLOWSION ENGINE FLUSH KITS

A must for salt water riders! All metal construction - easy to use - just push into aftermarket water bypass. No tools, clamps or extra hoses necessary. Back flushes entire cooling system instead of forcing salt and sand into cooling jackets. Simple and effective.

Description	Part No.
C. Blowsion Single Flush Kit	06-04-001
D. Blowsion Triple Flush Kit	06-04-002

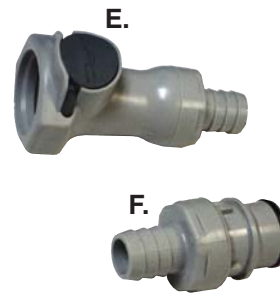

Description	Part No.
E. 1/2" Female in line	64-0117
F. 1/2" Male in line	64-0115

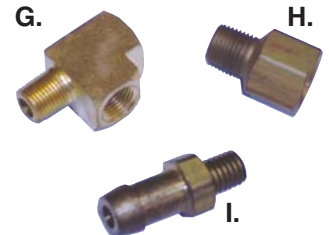

Brass Fitting	Part No.
G. 1/8" Male NPT Pipe Threaded Junction	64-0011
H. 1/8" Male NPT to 1/4" Female NPT Adapter	64-0013
I. 9mm Yamaha Flush Adapter	64-0004

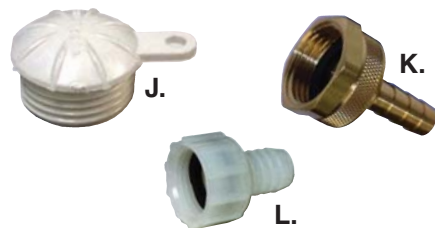

GARDEN HOSE ADAPTER & CAP

Description	Part No.
J. Plastic Garden Hose Adapter Cap	64-0029
K. Brass Garden Hose Adapter with 3/8 Hose Barb	64-0012
L. Plastic Hose Adapter 5/8" Hose Barb	64-0031

*Includes adapter to hose washer/seal

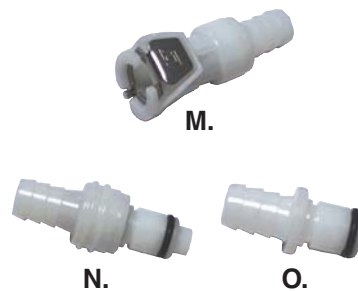

Description	Part No.
M. 3/8" In Line Female Fitting	64-0103
N. 3/8" with Shut Off Male (Barbed) Fitting	64-0107
O. 3/8" without Shut Off Male (Barbed) Fitting	64-0109



SNAP CONNECT & FLOW CONTROL

This flush kit includes adapter and also includes a quick disconnect that features a on/off water valve to make flushing the watercraft a simple and easy process.

Description	Part No.
Q. Snap Connect and Flow Control Set	SC-2900
P. Adaptor Only	SC-2905

FOUR STROKE
 INTAKE SYSTEMS
 ENGINE/GASKETS
 EXHAUST
 DRIVE LINE HANDLING
 ELECTRICAL
 WATERLINE/BILGE
 STEERING & CONTROLS
 BODY
 ACCESSORIES
 SERVICE TOOLS/HARDWARE
 CHEMICAL



WATER STRAINER

The **Water Strainer** is a must to trap all sand, shell, and vegetation particles.
No more clogged water lines!!
 Height=2" (51mm)
 Footprint= 2-1/2" (64mm) - Round

Description	Part No.
3/4" Water Line Strainer for Sea-Doo 4-Stroke	56-9004
1/2" Water Line Strainer	56-9005
3/8" Water Line Strainer	56-9006
#20 Mesh Replacement	20420020
#40 Mesh Replacement (#40 Mesh is finer than #20 Mesh)	20420040

A.



B.



JET WORKS QUICK DISCONNECT WATER RESTRICTOR

QD-38 comes with 4/3/2mm restrictor inserts used for controlling water flow through exit passes, stinger, head pipes, etc. QD-14 is for use with Mikuni Jets (not included), and allows quick change in small increments of water flow.

Description	Part No.
A. Quick Disconnect Wtr Restrictor 1/4"	QD-14
B. Quick Disconnect Wtr Restrictor 3/8"	QD-38



JET WORKS ADJUSTABLE WATER RESTRICTOR

Allows user to adjust flow on any 3/8" ID waterline. A great product for fine tuning engine/exhaust temperature for maximum power.

Description	Part No.
Adjustable Water Restrictor	JWR-01

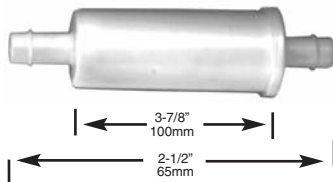

FACTORY PIPE CHAMBER WATERLINE FILTER

Description	Part No.
Waterline Inline Filter	COMFTG0036

F.



G.



RIVA RACING ALUMINUM THRU HULL CONNECTORS

RIVA Racing's aluminum thru hull fittings are anodized to prevent corrosion. Available in 3/8" and 1/2" waterline applications.

Description	Part No.
F. 3/8" Thru Hull Connector	RY1013-TH-3/8
G. 1/2" Thru Hull Connector	RY1013-TH-1/2

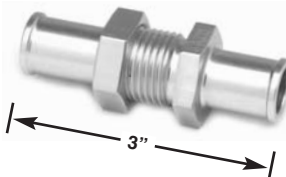

GP1300R 1/2" X 1/2" BULKHEAD FITTINGS

The R&D Billet Aluminum Fitting allows for easy installation for extra cooling lines through the bulk head.

Description	Part No.
1/2" x 1/2" Bulkhead Fittings	660-00012

STAINLESS STEEL HOSE CLAMPS

Hose clamps are sold individually. Discounted pricing available when 10 or more per size.

Size	Min	Max	Use	Part No.
#4	1/4" (6mm)	5/8" (16mm)	Fuel and 3/8" Waterline	6260451*
#5	1/4" (7mm)	3/4" (19mm)	3/8" and 1/2" Waterline	62M0551
#6	5/16" (8mm)	7/8" (22mm)	3/8" and 1/2" Waterline	6260651
#10	1/2" (13mm)	1-1/16" (27mm)	3/4" Bilge Hose	62M10
#16	5/16" (8mm)	1-1/2" (38mm)	1-1/8" Bilge Hose	62M16

*The new #4 clamp is perfect for 3/8" waterline, when the clamp is tight there is a very short tail to create a very clean installation and prevent snagging your hand when working in the engine compartment.



Fast, Easy, Strong and Secure Installation



SQUEEZE ON STAINLESS STEEL LOW PROFILE CLAMPS

See page 125 for more information



JETWORKS RESTRICTOR

Includes 3 different sizes of restrictor inserts which allow you to adjust water flow.

Description	Part No.
Jetworks Restrictor	JW-WRK





HOT PRODUCTS 90 DEGREE BYPASS FITTING

Hose	Color	Part No.
3/8" ID	Silver	56-2010
3/8" ID	Black	56-2012
3/8" ID	Blue	56-2014
3/8" ID	Red	56-2016

Hose	Color	Part No.
1/2" ID	Silver	56-3010
1/2" ID	Black	56-3012
1/2" ID	Blue	56-3014
1/2" ID	Red	56-3016

ID = Inner Diameter

HOT PRODUCTS 45 DEGREE BYPASS FITTING

Hose	Color	Part No.
3/8" ID	Silver	56-2020
3/8" ID	Black	56-2022
3/8" ID	Blue	56-2024
3/8" ID	Red	56-2026

Hose	Color	Part No.
1/2" ID	Silver	56-3020
1/2" ID	Black	56-3022
1/2" ID	Blue	56-3024
1/2" ID	Red	56-3026

ID = Inner Diameter

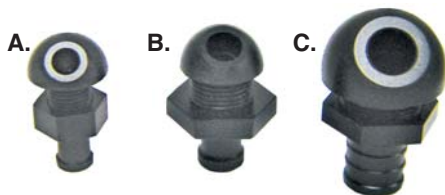

RRP WATER FITTINGS

These specially developed RRP Water Fittings are manufactured from Black Delron. The fittings are the lightest available, and being made of Delron they will not fuse together like other aluminum fittings available.

Description	Part No.
A. 45° Bypass Fitting 3/8"	PL-3/8-OUT
B. 45° Bypass Fitting 1/2"	PL-1/2-OUT
C. 45° Bilge Fitting 3/4"	PL-45-BILGE



LOWER RIDER BILGE FITTINGS

Looking for some bling bling? New Thrust "low rider" bilge fittings and bypass fittings will give your ski that custom touch you're after. These low profile billet aluminum fittings are extremely light yet durable.

Lower Rider Bilge Fitting	Part No.
Black	TI-LR-BBF-BLK
Blue	TI-LR-BBF-BLU
Green	TI-LR-BBF-GRN
Orange	TI-LR-BBF-ONG
Red	TI-LR-BBF-RED
Silver	TI-LR-BBF-SIL



LOWER RIDER BYPASS FITTINGS

Lower Rider Bypass Fitting	Part No.
Black	TI-LR-BPF-BLK
Blue	TI-LR-BPF-BLU
Green	TI-LR-BPF-GRN
Orange	TI-LR-BPF-ONG
Red	TI-LR-BPF-RED
Silver	TI-LR-BPF-SIL

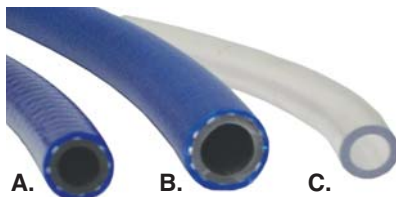

WATER LINE HOSE

Description	Part No.
A. 3/8" ID Blue 300psi WP (Eaton Synflex)	56-8000
3/8" ID Blue 300psi WP (Goodyear Pliovic Plus)	56-8015
B. 1/2" ID Blue 250psi WP (Goodyear Pliovic Plus)	56-8004
C. 3/8" Clear Vinyl	56-8007

500 foot reel 3/8" blue hose available and 400 foot reel 1/2" blue hose available
Call for special pricing on reel purchases.

See page 318 for more information about waterline and related items



WATER LINE SILICONE TUBING

Description	Part No.
3/8" ID Blue (Venair Technosil) Silicone Tubing (Sold in 25' lengths)	56-8012-25



HELIX HIGH PRESSURE TUBING

Helix High Pressure Tubing is a premium polyurethane, 85 durometer, which provides for superior abrasion, kink, tear, oxidation and chemical resistance. This tubing is very strong with a nylon inner band yet stays flexible. 3/8" ID x 9/16" OD Polyurethane, Nylon Interbraid Color Match Water Line

Description	Part No.
25 Foot HP Red Water Line	380-9175
25 Foot HP Yellow Water Line	380-9176
25 Foot HP Blue Water Line	380-9177
25 Foot HP Green Water Line	380-9178
25 Foot HP Clear Water Line	380-9179

rule®

RULE BILGE PUMP



A. 500 GPH



B. 800 GPH



Description	Hose	Height	Part No.
1100 GPH	1-1/8"	4-1/4" (108mm)	27D



PWC AUTOMATIC 500 GPH PUMP

Automatically removes water from engine compartment. Cycles every 20 seconds to check for water. Equipped with gasoline resistant strainer base and 72" wire leads.

Description	Hose	Height	Part No.
500 GPH	3/4"	4" (102mm)	25S-6WC



PWC GAS RESISTANT 500 GPH PUMP

Manually activated pump removes water from engine compartment. Equipped with gasoline resistant strainer base and 72" wire leads.

Description	Hose	Height	Part No.
500 GPH	3/4"	3-1/2" (89mm)	25D-6WC

Manually activated pump removes water from engine compartment. Equipped with 30" wire leads.

Description	Hose	Height	Part No.
A. 500 GPH	3/4"	3-1/2" (89mm)	25D
B. 800 GPH	3/4"	3-3/4" (96mm)	20R



RULE STRAINER BASE & S/S DEBRIS STRAINER

Description	Part No.
C. Blue Plastic Strainer Base	RULE275
C. Black Gas Resistant Strainer Base	RULE276
D. Stainless Steel Debris Strainer	RULE70

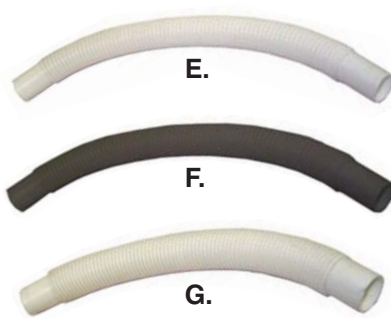

PLASTIC BILGE HOSE

Description	Length	Part No.
E. 3/4" Hose	12"	57-4008
F. 3/4" Hose	12"	57-4008-BLK
3/4" Hose (10-pack)	120"	57-4008-BLK-10PK
G. 1-1/8" Hose	12"	57-4009
Clamp for 3/4" Hose		62M10
Clamp for 1-1/8" Hose		62M16

STRAIGHT BILGE FITTING

Aluminum through hull outlet fittings.



Bilge Fitting	Color	Part No.
H. 3/4" Straight	Silver	57-4012
I. 3/4" Straight	Black	57-4015
J. 3/4" Straight	Blue	57-4016
K. 3/4" Straight	Red	57-4017

STRAIGHT BILGE FITTING

Aluminum through hull outlet fittings.

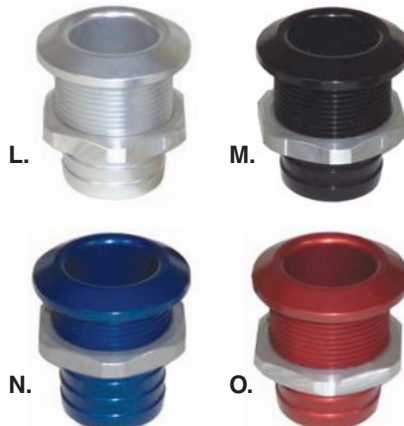

Bilge Fitting	Color	Part No.
L. 1 1/8" Straight	Silver	57-4018
M. 1 1/8" Straight	Black	57-4020
N. 1 1/8" Straight	Blue	57-4027
O. 1 1/8" Straight	Red	57-4028

45 DEGREE BILGE FITTING

Aluminum through hull outlet fittings.



Description	Color	Part No.
P. 3/4"	Silver	57-4021
Q. 3/4"	Black	57-4023
R. 3/4"	Blue	57-4024
S. 3/4"	Red	57-4025

BILGE PUMP MOUNTING BRACKETS

Yamaha	Part No.
A. WaveBlaster/701 Super Jet 95+	57-3029
Kawasaki	Part No.
B. 440/550	57-3023
C. 650SX/X2, 550SX, 750SX, SXI	57-3024
D. 750SS/XI/ST/STS	57-3025
Polaris	Part No.
E. Polaris -98	SE-044011

BLOWSION DUAL BILGE PUMP MOUNTING BRACKET

Description	Part No.
F. Kawasaki 800SX-R	06-01-101
G. Superjet 1996-2016	06-01-153

R&D SX-R 800 RULE BILGE PUMP MOUNTING BRACKET

The R&D Bilge Pump Mount Bracket bolts securely to the hull developing a secure surface to hold the Bilge pump in place.

Kawasaki	Part No.
800SX-R	660-80000

NEW



KOMMANDER SUPERJET/BLASTER BILGE PUMP BRACKET

- Manufactured from Aircraft quality 6061 Alloy and anodized for corrosion protection.
- Mounts solidly to your Yamaha bulkhead bearing carrier.
- Kommander exclusive spacer shim makes for a perfect fit and holds pump securely in place so that it will not wobble or move around.
- Fits both the 500 and 800 GPH bilge pumps.
- This new pump location means you can run either the 500 or 800 GPH bilge pump without hitting the Yamaha OEM couplers.

Description	Part No.
Superjet (1996-2016) WaveBlaster	KOM-200-SJBB



BILGE ELECTRICAL PARTS KIT

Kit contains waterproof fuse holder, 6amp fuse, ring terminal shrink tubing.

Description	Part No.
F. Bilge Electrical Parts Kit	57-3030
G. Fuse Only (3 pcs)	57-3033



JAPANESE OEM STYLE CONNECTOR

Description	Part No.
OEM Style Electric Connector Kit 5pcs/pk	55-2035
Dealer Kit 20pcs/pk	55-2037

MALE/FEMALE TERMINAL KIT

This kit includes 30 of both the male and female terminals and plastic sleeves/covers. The terminals are tin plated to prevent corrosion. The terminal kit is provided in a handy plastic case.

Description	Part No.
Male/Female Terminal Kit	16-601



ADHESIVE LINED HEAT SHRINK BUTT CONNECTORS

Best used where moisture and corrosion is a problem. After crimping these terminals to wire, heat is applied enabling the adhesive within each shrunk tube terminal to melt and flow evenly to seal the connection against the harshest environment.

Description	Wire Range	Part No.
10pcs/pk Pink	22-18 (0.3-0.8mm)	55-2040
100pcs/pk Pink	22-18 (0.3-0.8mm)	55-2041
10pcs/pk Blue	16-14 (1-2mm)	55-2042
100pcs/pk Blue	16-14 (1-2mm)	55-2043

FOUR STROKE
 INTAKE SYSTEMS
 ENGINE/GASKETS
 EXHAUST
 DRIVE LINE HANDLING
 ELECTRICAL
 WATERLINE /BILGE
 STEERING & CONTROLS
 BODY
 ACCESSORIES
 SERVICE TOOLS
 CHEMICAL
 HARDWARE

HOT PRODUCTS WATERPROOF SWITCHES AND BRACKETS

- Features waterproof on/off switch that is available with machined aluminum clamp-on or switch mounted bracket. Allows totally reliable and easy control of bilge pump operation.
- Mounting bracket is machined from billet alloy and is anodized black to prevent corrosion. Available for clamp-on bar mounting or bolts to the bottom of the OEM on/off switch assembly.
- All of the switches have a 9 ft. high grade wire lead.

UNIVERSAL



Yamaha Part No. 57-3017
All



Description Part No. 57-3006
Universal Handle Bar Mount



Kawasaki Part No. 57-3015
All 650/750SS-95/XI-93



Kawasaki Part No. 57-3003
440/550/750SX
750SX/800SX-R



Description Part No. 57-3009
Standard Switch with
9 feet of wire (No bracket included)

Hot Products PWC Waterproof Switches Imported Exclusively from



57-3020

**HOT PRODUCTS
EXCLUSIVE**

3-POSITION PANEL MOUNT ROTARY SWITCHES

Connects to two electronic accessories for power control. Allows the operation of one device or accessory to run at a time. Suggested uses: Second Bilge, Ignition, etc. 12Volt/5Amp.



Left Hand On Position
Use: Blue & Red Wires

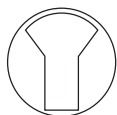

Center Off Position



Right Hand On Position
Use: White & Red Wires



JP7043 can be installed with Hot Products Throttle Lever 58-0970 & 58-0971 as pictured above.

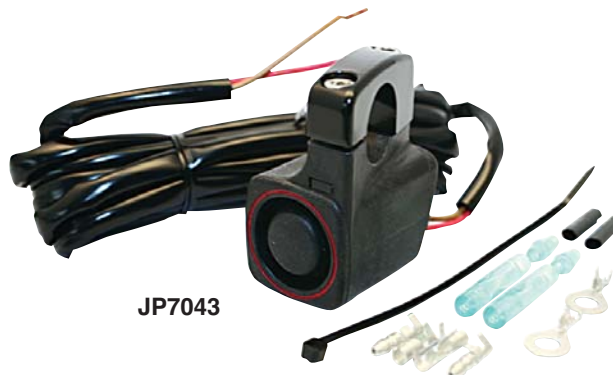

JP7043

UNIVERSAL HANDLEBAR MOUNT SWITCHES

Mounts to handlebar or mounts to underside of most aftermarket throttle levers. Complete with 9" wire lead.

Description Part No. 57-3020
Panel Mount Switch

Description Part No. JP7043
Handlebar Mount Switch 12Volt/6Amp push on/off switch



BLOWSION CAS BILLET ALUMINUM ONE WAY VALVE SCUPPER

The new CAS flow valve design prevents water getting in during tail stands, wave jumping, or all out buoy shredding. The new billet flange assembly is the premium design setup and allows use of the Blowsion billet exhaust outlet so vain riders can sanitize both sides of the rear of their watercraft. The aluminum, rubber, and injection molded construction of the Blowsion one-way valve assembly along w/ the recessed internal mounting results in a bulletproof set-up. **Fits all years Super Jet, Kawasaki 650, 750, 800 SXR and Polaris Octane.** Each pre-assembled kit includes explicitly detailed instructions, two Blowsion molded glue able urethane bulkhead and ski flanges for leak less sealing, recessed one-way flow valve, special flex tubing (allows for off center mounting unlike straight PVC tube scupper systems) mounting epoxy and stainless fasteners.

Description	Part No.
Blowsion CAS Aluminum One Way Valve Scupper	06-01-022



BLOWSION ONE WAY VALVE

Unlike scupper valves that mount on the exposed exterior of your ski, Blowsion one way valve kits install "into" the rear 1/4 of your PWC end caps. This keeps continual water pressure on the inside of the tube, keeping the valve shut when the ski is floating.

Description	Part No.
Pro Finish Kit	06-01-028



RICK ROY PRODUCTS SCUPPER VALVE

Description	Part No.
RRP Scupper Valve	RRP-SCU-V
Replacement Flap Only	RRP-SCU-V-FLAP



BILGE SPONGE

This Viscose-Covered sponge will pick up and hold an amazing 32 ounces (512gm) of water without leaking. With grommet and hand cord.

Description	Part No.
Bilge Sponge	57-4070



DUCK BILL DRAIN ADAPTER PLUG

Unscrew stock drain plug and screw our duck bill drain plugs in place. Keep your stock plug if you ever need to change!

Description	Part No.
H. Kawasaki	Z471
I. Yamaha	Z472



A.



B.

BILLET QUICK DRAIN

Description	Part No.
A. Kawasaki 1200 STX-R, 800 SX-R	57-4065
B. Billet Quick Drain Kit	57-4059



C.

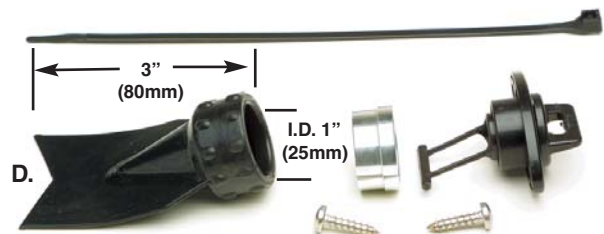

D.



E.



F.



G.

DUCK BILL DRAIN SYSTEM

Simple and clean, drains water from hull under acceleration.

C. Add to your current drain plug or D. Purchase entire system kit.

Description	Part No.
C. All Sea-Doo (Except XP) All Sit down Yamaha / Kawasaki*	57-4050
D. Universal (Complete System)	57-4060
E. Drain Plug Only Sea-Doo (95 and newer), Polaris, and Honda	A2265
F. Sea-Doo 2009+ 3 seat with i control, Single Drain	A7026
G. Sea-Doo 2009+ 3 seat with i control, Dual Drain Duck Bill Flapper only	A7027 57-4055

*Kawasaki models require slight modification

FOUR
STROKE

INTAKE
SYSTEMS

ENGINE/
GASKETS

EXHAUST

DRIVE LINE
HANDLING

ELECTRICAL

WATERLINE
/BILGE

STEERING
& CONTROLS

BODY

ACCESSORIES
SERVICE TOOLS

/HARDWARE

CHEMICAL



“THE ORIGINAL” VERSIPLUG DRAIN SYSTEM

Versiplug (The original) fits Yamaha, Kawasaki, Sea-Doo, Honda, Polaris and Hydrospace.



Yamaha (pre-2003) (All GPR)	Color	Part No.
Versiplug	Silver	PD1200
Versiplug	Black	PD1201

Sea-Doo (pre-2009)/Honda/Polaris/ Yamaha (2004+) (Except GPR)	Color	Part No.
Versiplug	Silver	PD1400
Versiplug	Black	PD1401



Kawasaki	Color	Part No.
Versiplug	Silver	PD1300
Versiplug	Black	PD1301



Sea-Doo (2010+)	Color	Part No.
A. Versiplug	Silver	PD1420
B. Versiplug	Black	PD1421

Hydrospace	Color	Part No.
C. Versiplug	Black	PD1151

NEW



VERSIPLUG-RACE

Utilizing the proven Versiplug PD1300 design, PWC Doctor has modified the design to incorporate a duckbill to double the protection from water entering the hull. This design is for racing applications only and is made from Delrin to prevent hull damage if the Versiplug is hit during a race.

Kawasaki	Color	Part No.
Versiplug-Race	Black (Delrin)	PD1450

“THE ORIGINAL” VERSIPLUG-MAX! DRAIN SYSTEM

NEW

Versiplug Max High Flow - The newest high flow Versiplug for the standard 1-63/64" drain tubes, this Versiplug is the highest flowing drain system available, flows approx. 70% more than previous system.



**Picture is for reference only*

Description	Color	Part No.
Versiplug Max - High Flow	Black (Delrin)	PD1800

Versiplug Max - The rugged solution for leaky flap scuppers. Created for freestyle to create a reliable fix to scupper setups that had leaking issues when not moving.



Description	Color	Part No.
Versiplug Max	Black	PD1701

Versiplug Max Rickter - The new Versiplug Rickter has been manufactured out of Delrin to be lightweight and strong. Can be used with Rickter Scupper flap or as a stand-alone drain system upgrade.

Description	Color	Part No.
Versiplug Max - Rickter	NEW Black (Delrin)	PD1900

“THE ORIGINAL” VERSIPLUG-R DRAIN SYSTEM

Versiplug-R - Developed for the serious PWC enthusiast and racers. Higher flowing and lighter weight than the original Versiplug



Description	Part No.
Versiplug-R - Black	PD1600

VERSIPLUG FILTER

The PWC Doctor filter has been developed to prevent debris that has traveled down the drain tube from the engine compartment from causing the Versiplug drain ball to not seal properly. Versiplug filter color is black.



Description	Part No.
Versiplug Filter	PD-FILTER-K

**The Versiplug filter is for use with PD1200/1201/1300/1301/1400/1401/1151/1420/1421*

WSM REPLACEMENT STEERING CABLES



MODEL	YEAR	OE NO.	PART NO.
SEA-DOO			
580 GT	90-91	277-000-152	002-045
580 GTS	92	277-000-152	002-045
580 GTS	93	277-000-229	002-046
580 GTS	94	277-000-261	002-045-01
580 GTS	92-95	271-000-436	002-045-02
580 GTX	92	277-000-152	002-045
580 GTX	93	271-000-436	002-045-02
580 SP	89-93	277-000-228	002-046
580 SP	94-96	277-000-289	002-048-01
580 SPI	93	277-000-228	002-046
580 SPI	94-96	277-000-289	002-048-01
580 SPX	93	277-000-228	002-046
580 XP	91-92	277-000-228	002-046
650 GTX	94	277-000-261	002-045-01
650 GTX	95	271-000-436	002-045-02
650 SPX	94-95	277-000-289	002-048-01
650 XP	94	277-000-267	002-048-02
650 XP	94	277-000-289	002-048-01
650 XPI	94	277-000-289	002-048-01
720 GS	97-01	271-000-436	002-045-02
720 GSI	97	271-000-436	002-045-02
720 GTI	96-97	271-000-436	002-045-02
720 GTI	97-00	277-000-526	002-045-06
720 GTI	01-04	277-001-010	002-045-08
720 GTI LE	02-04	277-001-010	002-045-08
720 GTS	96-00	271-000-436	002-045-02
720 GTS	2001	277-001-010	002-045-08
720 SP	97	277-000-289	002-048-01
720 SPX	96-97	277-000-289	002-048-01
720 XP	95	277-000-467	002-048-03
800 GSX	96-97	271-000-436	002-045-02
800 GSX RFI	2000	277-000-841	002-046-02
800 GTI RFI	2004	277-001-010	002-045-08
800 GTI LE RFI	03-04	277-001-010	002-045-08
800 GTX	96-97	277-000-526	002-045-06
800 GTX RFI	99-00	277-000-842	002-046-03
800 SPX	98-99	277-000-289	002-048-01
951 GSX	97-98	271-000-436	002-045-02
951 GSX LTD	97	277-000-367	002-045-02
951 GTX	2000	277-000-843	002-046-04
951 GTX	01-02	277-001-010	002-045-08
951 GTX DI	2000	277-000-842	002-046-03
951 GTX DI	02-03	277-000-949	002-046-05
951 GTX LTD	98	277-000-526	002-045-06
951 GTX LTD	99	277-000-843	002-046-04
951 RX	01-02	277-001-011	002-045-05
951 RX	2000	277-001-841	002-046-02
951 RX DI	2000	277-000-841	002-046-02
951 RX DI	01-03	277-001-011	002-045-05
951 XP	01-02	277-001-008	002-045-04
951 XP DI	03-04	277-001-008	002-045-04
951 XP LTD	98-99	277-000-773	002-046-01
4-TEC GTX	02-04	277-000-949	002-046-05
4-TEC GTX LTD SC	03-04	277-000-949	002-046-05
4-TEC GTX SC	03-04	277-000-949	002-046-05
4-TEC GTX WAKE BOARD	03-04	277-000-949	002-046-05
KAWASAKI			
300 SX	86-88	59406-3001	002-069
400 SX	76-79	59406-3001	002-069
440 SX	77-92	59406-3001	002-069
550 SX	82-95	59406-3001	002-069
650 SC	91-95	59406-3724	002-074-03
650 SX	87-90	59406-3705	002-074
650 SX	91-93	59406-3720	002-043
650 TS	89-96	59406-3714	002-040
650 X2	88-95	59406-3712	002-073
650 X2	86-87	59406-3723	002-070
750 SS	92-97	59406-3728	002-044-01
750 SSXI	93-97	59406-3732	002-044
750 STS	95-97	59406-3736	002-042-01
750 STX	98	59406-3736	002-042-01
750 SX	92-95	59406-3726	002-041
750 SXI	95-96	59406-3726	002-041

MODEL	YEAR	OE NO.	PART NO.
KAWASAKI CONTINUED...			
750 SXI PRO	98-02	59406-3726	002-041
750 XI SPORT	98-99	59406-3728	002-044-01
750 ZXI	95-97	59406-3746	002-042-02
800 SX-R	03-11	59406-3776	002-040-04
900 STS	01-02	59406-3748	002-042-03
900 STX	98	59406-3736	002-042-01
900 STX	99-02	59406-3748	002-042-03
900 STX	03-06	59406-3778	002-040-02
900 ZXI	95-97	59406-3746	002-042-02
1100 STX	97-99	59406-3748	002-042-03
1100 STX D.I.	00-02	59406-3748	002-042-03
1100 STX D.I.	2003	59406-3778	002-040-02
1100 ULTRA 130	01-04	59406-3771	002-042-04
1100 ZXI	96-03	59406-3757	002-040-01
1200 STX	03-04	59406-3778	002-040-02
1200 STX 12F	03-07	59406-3778	002-040-02
1200 STX-R	02-03	59406-3748	002-042-03
1200 STX-R	04-05	59406-3778	002-040-02
1200 ULTRA 150	99-05	594063-3771	002-042-04
1500 STX 15F	04-12	59406-3778	002-040-02
ULTRA 250 X	07-08	59406-3780	002-040-06
ULTRA 260 LX			002-040-06

MODEL	YEAR	OE NO.	PART NO.
YAMAHA			
500 LX	93	EU0-U1481-00	002-051
500 WAVE JAMMER	89-90	EW3-61481-02	002-050
500 WAVE RUNNER	89, 92-93	EU0-U1481-00	002-051
650 SUPER JET	90-93	EW2-61481-00	002-059
650 WAVE RUNNER III	90-96	FJ0-61481-00	002-049
650 WAVE RUNNER VXR	91-95	FN8-U1481-00	002-042
701 FX	94-95	FX1-61481-00	N/A
701 RAIDER	94	GH1-61481-02	002-059-01
701 RAIDER	95-97	GH6-U1481-00	002-051-04
701 SUPER JET	94	EW2-61481-00	002-059
701 SUPER JET	95	EW2-U1481-00	N/A
701 SUPER JET	96-04	GM6-61481-00	002-059-03
701 SUPER JET	08-14	F2F-61481-00-00	002-059-06
701 VXR PRO	93-94	FN8-U1481-00	002-042
701 WAVE VENTURE	98	GP3-61480-00	N/A
701 WAVEBLASTER	93-96	GA7-61481-00	002-058
701 WAVE RUNNER III	97	FJ0-61481-00	002-049
701 WV	95-96	GJ3-U1481-00	002-059-02
701 XL	99-01	GU2-U1481-10	002-059-05
760 GP	99-00	GP7-U1481-00	002-051-05
760 RAIDER	96	GH6-U1481-00	002-051-04
760 WAVEBLASTER	96	GK5-61480-00	N/A
760 WAVE RUNNER	97-98	GP7-U1481-00	002-051-05
760 WAVE VENTURE	97	GP3-61480-00	N/A
760 XL	99	GU2-U1481-01	002-059-05
800 GP	98-00	GP7-U1481-00	002-051-05
800 GP	01-02	F0X-U1481-00	002-051-02
800 GP	2003	F0X-U1481-10	002-051-02
800 GP	2004	F0W-61481-01	N/A
800 XA	2004	F0D-U1481-10	002-051-01
800 XL	02-04	F0D-U1481-10	002-051-01
1000 FX/HIGH OUTPUT	2004	F1B-61481-02	N/A
1100 RAIDER	95-96	GJ1-U1481-00	002-058-01
1100 WAVE VENTURE	96-97	GH3-61480-00	002-051-03
1200 GP	97-99	GP8-U1481-00	002-059-04
1200 GP	00-02	F0X-U1481-00	002-051-02
1200 XA	2004	F0D-U1481-10	002-051-01
1200 XL	98	GU2-U1481-10	002-059-05
1200 XLT	03-04	F0D-U1481-10	002-051-01
1300 GP R	2004	F1G-61481-02	N/A
1400 FX	02-03	F1B-61481-01	N/A
1800 FX	11-14	F1S-61481-10-00	002-051-14

FOUR
STROKE

INTAKE
SYSTEMS

ENGINE/
GASKETS

EXHAUST

DRIVE LINE
HANDLING

ELECTRICAL

WATERLINE
/BILGE

STEERING
& CONTROLS

BODY

ACCESSORIES
/HARDWARE

SERVICE TOOLS

CHEMICAL

HOT PRODUCTS RUNABOUT HANDLEBARS

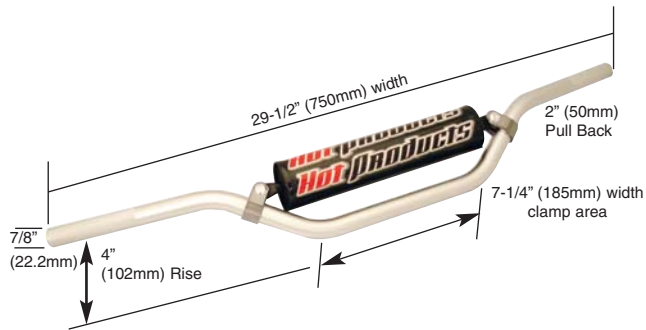

Runabout (750mm Width)	Color	Part No.
Runabout Handlebars	Silver	HJR-01

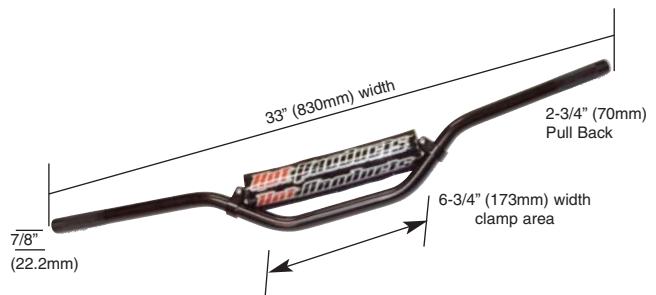

Runabout (830mm Width)	Color	Part No.
Runabout Handlebars	Black	HJR-NW-83BK

HOT PRODUCTS STAND-UP HANDLEBARS



Stand-up Extended Handlebars	Color	Part No.
Yamaha/Kawasaki Zero Degree	Black	HP-00-68BK

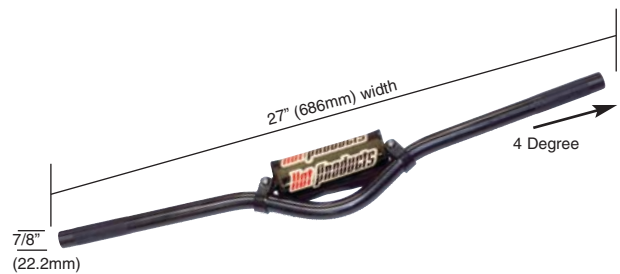

Stand-up Extended Handlebars	Color	Part No.
Yamaha/Kawasaki 4-Degree	Black	HP-04-68BK

RIVA RACING PERFORMANCE HANDLEBARS

- Made from 7/8" proprietary T6 aluminum alloy for superior tensile strength & vibration dampening
- Cross bar clamps CNC machined from 6061 aluminum and mounted with stainless hardware & threadlock
- Cross bar made from cold forged aluminum

- Includes high density foam pad & cover
- High tech, shot peened and anodized finish for unmatched durability
- Knurled ends offer better grip adhesion (accepts popular Lock-on ODI grips)
- Available in black or silver



Stand-Up Handlebars	Color	Part No.
0 Degree w/Crossbar & Pad	Silver	RY201SI-BAR-2
0 Degree w/Crossbar & Pad	Black	RY201BK-BAR-2



Stand-Up Handlebars	Color	Part No.
4 Degree w/Crossbar & Pad	Silver	RY202SI-BAR-2
4 Degree w/Crossbar & Pad	Black	RY202BK-BAR-2



Sit-Down Handlebars	Width	Color	Part No.
Sport/Runabout Handlebar	29"	Silver	RY203SI-BAR-2
Sport/Runabout Handlebar	29"	Black	RY203BK-BAR-2



Sit-Down Handlebars	Width	Color	Part No.
Runabout Handlebar	32"	Silver	RY204SI-BAR-2
Runabout Handlebar	32"	Black	RY204BK-BAR-2



KOMMAND HANDLEBARS



Stand-Up Handlebars	Color	Part No.
0-Degree W/Crossbar & Pad- Extended	Clear	03-05-141
0-Degree W/Crossbar & Pad- Extended	Black	03-05-142



Stand-Up Handlebars	Color	Part No.
4-Degree W/Crossbar & Pad- Extended	Clear	03-05-143
4-Degree W/Crossbar & Pad- Extended	Black	03-05-144



Stand-Up Handlebars	Width	Color	Part No.
Fat-Bar Straight	25.5"	Black	03-05-145
Fat-Bar 4 Degree	25.5"	Black	03-05-148



Stand-Up Handlebars	Width	Color	Part No.
Fat V Bar Riser	25.5"	Black	03-05-146



Sit-Down Handlebars	Width	Color	Part No.
Blaster/Sports Handlebars	28"	Black	03-05-150



Sit-Down Handlebars	Width	Color	Part No.
Runabout Handlebars	32"	Black	03-05-152
Runabout Handlebars	32"	Clear	03-05-153



RIVA HANDLEBAR FOR iCONTROL SKIS

Description	Width	Color	Part No.
RIVA iControl RXP-X 260/300, RXT-X 260/300	32"	Black	RS205B-IC



MOTOINE ADJUSTABLE HANDLEBAR

Utilizing handlebar clamp holes, this Motorcycle Road Racing type handlebar allows you to adjust the handlebar position from -4 degrees to +16 degrees.

Kawasaki	Part No.
Adjustable Handlebar for 800SXR	MR-SXR-012

FOUR STROKE
INTAKE SYSTEMS
ENGINE/GASKETS
EXHAUST
DRIVE LINE HANDLING
ELECTRICAL
WATERLINE /BILGE
STEERING & CONTROLS
BODY
ACCESSORIES
SERVICE TOOLS /HARDWARE
CHEMICAL



Mounting System

UMI RACING SEALED BEARING POWER TURN PLATE STEERING SYSTEM

Description	Part No.
SuperJet/Kawasaki 800SXR* Mounting System	JS-04103
<i>This Steering System does not fit on a Kawasaki OEM Handlepole.</i>	



A.

B.



SJ 96+ Handlebar Pad Cover

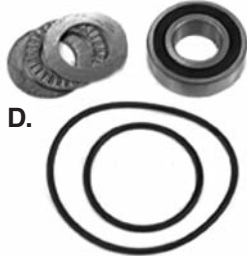

Replacement Bearing Kit



E.

Description	Part No.
A. Set of Clamps with Bolts, Silver	30-522590
B. Set of Clamps with Bolts, Black	30-522500
C. UMI Super Jet 96+ Handlebar pad cover	YA-04109
D. UMI Replacement Bearing Kit	YA-04110
E. Handlebar Clamp Bolt Kit (8x20 Socket Flat Head) 4 bolts per kit	59-9129



BLOWSION BILLET STEERING SYSTEM SEALED BEARING WITH KROK LOCK NUT

Description	Part No.
Blowsion Billet Steering System - Yamaha SJ, Kawasaki Conversion, Octane	03-05-001
Blowsion Krok Collar	03-05-019



635mm

22.2mm Straight Bars

RRP UNIVERSAL STEERING SYSTEM (22.2MM)

See page 81 for more information.

Description	Color	Part No.
RRP Univ. Steering System	Black	STR-SYST-UNIV-KIT-BLK
RRP Univ. Steering System	Silver	STR-SYST-UNIV-KIT-SLV
RRP Straight Bars (22.2mm Clamping Surface)		ST-B



RRP AST STEERING SYSTEM FOR 28.6MM FAT BARS

See page 80 for more information.

Description	Color	Part No.
RRP AST Steering System	Black	STR-SYST-UNIV-F-BLK-S
RRP AST Steering System	Red	STR-SYST-UNIV-F-RD-S
RRP AST Steering System	Silver	STR-SYST-UNIV-F-SLV-S
RRP AST Steering System	Green	STR-SYST-UNIV-F-GN-S
RRP AST Steering System	Blue	STR-SYST-UNIV-F-BLU-S

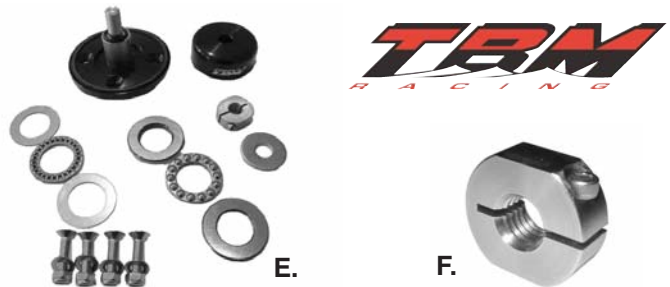

TBM RACING STEERING SYSTEM

Description	Part No.
E. TBM Racing Yam/Kaw/Pol Sealed Bearing Steering System	TBM126
TBM Racing Steering System Bearing Replacement Kit	TBM126-B
F. TBM Racing Steering System Lock Nut	TBM126-N

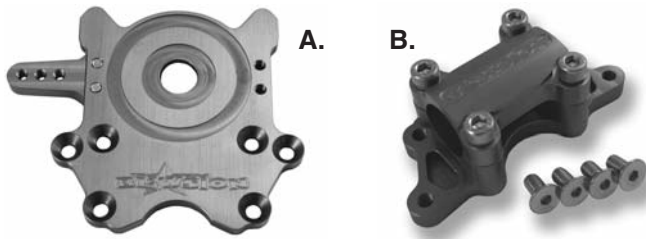

BLOWSION KOMMAND BILLET STEERING SYSTEM 7/8" BARS

Moves the normal rider position forward approximately 1 inch. Helps to reduce hull porpoising and dramatically improves handling. Fits both SuperJet and 800SX-R applications. Systems include: Blowsion sealed bearing system, turn plate, fat bar clamp and all hardware. *Black is not sold as a kit please order 03-05-001 (See page 250 for Bearing Kits) and 03-05-043.*

Description	Color	Part No.
A. Blowsion -1" Turn Plate	Black	03-05-043
B. Blowsion Phat Clamp	Black	03-05-018
Steering Kit 7/8" Bar	Black	03-05-004
Steering Kit 7/8" Bar	Green	03-05-025
Steering Kit 7/8" Bar	Blue	03-05-026
Steering Kit 7/8" Bar	Red	03-05-028
Steering Kit 7/8" Bar	Orange	03-05-029
Blowsion Steering Rebuild Kit		03-05-020



BLOWSION KOMMAND BILLET STEERING SYSTEM FAT BAR

Blowsion Fat Bar steering systems feature the same benefits and performance features as listed above in the 7/8" bar system. These Blowsion Fat bar systems are sold as complete kits only. Systems include: Blowsion sealed bearing system, turn plate, fat bar clamp and all hardware.

Description	Color	Part No.
Steering Kit 1-1/8" Bar	Blue	03-05-005
Steering Kit 1-1/8" Bar	Red	03-05-006
Steering Kit 1-1/8" Bar	Orange	03-05-007
Steering Kit 1-1/8" Bar	Green	03-05-008
Steering Kit 1-1/8" Bar	Black	03-05-010
Blowsion Steering Rebuild Kit		03-05-020



TBM RACING TURN PLATE & BILLET HANDLEBAR CLAMPS

Description	Part No.
C. TBM Racing Yamaha Turn Plate -1"	TBM102-YAM
D. TBM Racing Kawasaki Turn Plate -1"	TBM102
E. TBM Racing Kawasaki OEM Replacement Turn Plate	TBM102-OE
F. TBM Racing Billet Handle Clamps	TBM135
Color: Black (Sold as pair with 4 clamp bolts)	



THRUST INNOVATIONS EZ STEERING

Thrust Innovations advanced steering system is made from 6061 billet aluminum for strength and then hard anodized. The unique adjustable pivot allows the bar height to be easily adjusted to a -45 degree to +45 degree bar height. System features sealed ceramic bearing system wrapped around a 30mm steering post to insure low maintenance, high strength, and the smoothest steering to date. 28.6mm Fat Bar required.

Description	Part No.
Black	TI-EZ-STR-BLK
Silver	TI-EZ-STR-SIL
Red	TI-EZ-STR-RED
Blue	TI-EZ-STR-BLU
Orange	TI-EZ-STR-ORG



ADA BILLET STEERING SYSTEM

Billet steering plate for 1 1/8" fat bars and regular bars. Steering cable mount can be mounted on either side of the plate. This plate will work with the UMI and Blowsion style sealed bearing systems. *This system can also be used on the Kawasaki SXR by relocating the pivot post in the stock subplate to the forward hole.*

Description	Bar	Color	Part No.
ADA Billet Steering Plate	28.6mm Fat	Silver	34-521090
ADA Billet Steering Plate	28.6mm Fat	Black	34-521000
ADA Billet Steering Plate	22.2mm Reg.	Silver	30-523090
ADA Billet Steering Plate	22.2mm Reg.	Black	30-523000
Bearing Kit	Universal	Black	34-520000
Bearing Kit	Universal	Silver	34-520090
ADA Steering Rebuild Kit			34-520500



BLOWSION YAMAHA & KAWASAKI HEAVY DUTY STEERING CABLES

Description	Part No.
Blowsion Yamaha SJ	02-05-302
Fits all 1996-2007 Yamaha SuperJet and most aftermarket hull applications using Yamaha based platform (Rickter, Krash, Tigercraft, ETC.)	
Blowsion Kawasaki SXR (All Years)	02-05-303



UMI RACING YAMAHA TURN PLATE

Description	Color	Part No.
UMI Yamaha SJ Turn Plate	Silver	YA-04104-CLR
UMI Yamaha SJ Turn Plate	Black	YA-04104-BLK



For Rick Roy Handlepoles and RRP Steering related items, please see pages 76-87 for information and details.



FOUR STROKE

INTAKE SYSTEMS

ENGINE/GASKETS

EXHAUST

DRIVE LINE HANDLING

ELECTRICAL

WATERLINE /BILGE

STEERING & CONTROLS

BODY

SERVICE TOOLS ACCESSORIES /HARDWARE

CHEMICAL

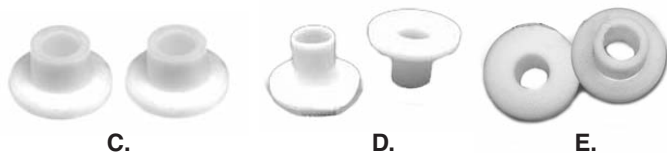
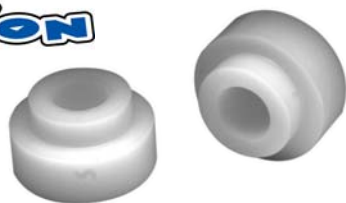

SXR PIVOT BOLT BUSHING FOR OEM BRACKET

UMI Handle Pole conversion for OEM SX-R bracket or AC Handlepole conversion for OEM SX-R Bracket.

Kawasaki SX-R	Part No.
For UMI Handlepole	03-04-101
For AC Handlepole	03-04-102

OEM HANDLEPOLE REPAIR/REPLACEMENT BUSHINGS

Bushings are sold in sets of two.

Description	Part No.
C. OEM Kawasaki 440/550/550SX/650SX Handlepole*	31-660115
<i>* These are oversized bushings and pivot bolt holes must be enlarged to fit bushings.</i>	
D. OEM Kawasaki 750/800 Handlepole	03-04-103
E. Yamaha SuperJet (96+) Handlepole	03-04-105
E. Yamaha UMI Handlepole with OEM SuperJet Pole Bracket	03-04-105
UMI Pole for Kawasaki 750/800	03-04-101



HANDLE POLE EXTENSION LIMITING ROPE

This pole limiting rope is to STOP pole from extending appx. 2-3" from total max extension. This prevents the forward motion of the pole. Fits all stand up Yamaha Super Jet, Polaris Octane, Kawasaki SXR 800, 750 SX & all JS models. A must for ocean or big wave riders

Description	Part No.
A. UMI Limiting Rope Kit	YA-09100
B. Blowsion Limiting Rope Kit	03-04-151



BLOWSION STEERING STOP

Blowsion stainless Steering Stop and nut. Updated design allows for two mounting positions for riders wanting more steering throw. Fits all OEM, UMI, Factory Yamaha, RRP and AC aluminum Handlepoles.

Description	Part No.
Blowsion Steering Stop with Nut	03-04-131



HANDLE POLE SPRINGS

Greatly reduces weight of stock handle pole up to 75% and reduces rider arm and shoulder fatigue.

Yamaha		Part No.
A.	Blowson SuperJet Pre 95	03-04-011
B.	Blowson SuperJet 96+	03-04-012
C.	SuperJet 96+ (Black)	58-5704
Kawasaki		Part No.
D.	Blowson 750SX, 750 SXI, 800SXR	03-04-003
E.	300/440/550/550SX	WCW-440SPRING
F.	650SX	WCW-650SXSPRING

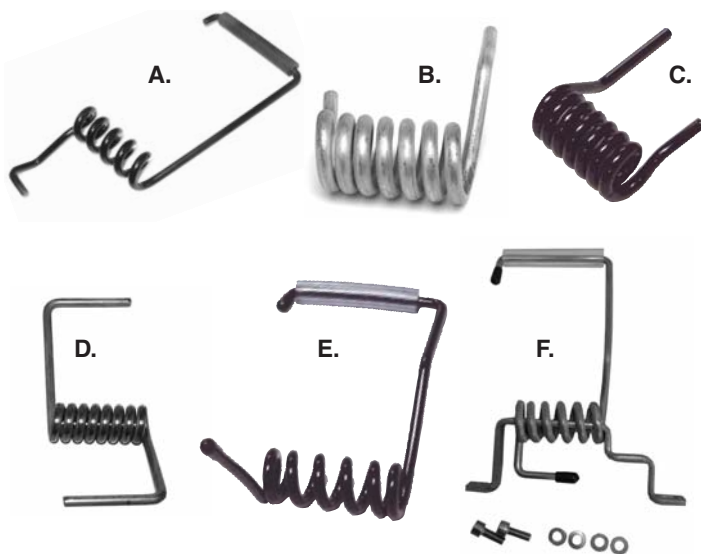

FOUR STROKE
INTAKE SYSTEMS
ENGINE/GASKETS
EXHAUST
DRIVE LINE HANDLING
ELECTRICAL
WATERLINE /BILGE
STEERING & CONTROLS
BODY
ACCESSORIES SERVICE TOOLS /HARDWARE
CHEMICAL



ADA RACING BILLET 800SXR TALL HANDLEPOLE SPRING TENSIONER

Kawasaki 800 SX-R handlepole spring tensioner. Includes billet black anodized bracket and stainless hardware.

Kawasaki	Height	Part No.
ADA Tensioner	25mm	KA800ST



KOMMANDER TENSIONER KAWASAKI 800 SXR

Kawasaki	Height	Part No.
800 SXR Tall	38mm	KOM104-TALL



WATERCRAFT WERKS KAWASAKI 750SX/SXI HANDLEPOLE SPRING TENSIONER

The Watercraft Werks Spring Tensioner adds preload to the handlepole which reduces the handlepole weight. The lighter handlepole reduces back, shoulder and arm fatigue. The stainless steel constructed shim installs in less than 5 minutes with basic tools.

Kawasaki	Part No.
Handlepole Spring Tensioner	WCW-75SXPST



TBM TENSIONER FOR KAWASAKI 800 SXR

Kawasaki	Part No.
800 SXR Short	TBM104-S
800 SXR Tall	TBM104-T



SXR BILLET HOOD BUMPER

Direct replacement for OEM bumper. Includes pre-cut foam and hardware. For Kawasaki 800SXR/750SXI.

Description	Part No.
Hood Bumper Clear	04-04-201
Hood Bumper Green	04-04-202
Hood Bumper Red	04-04-203

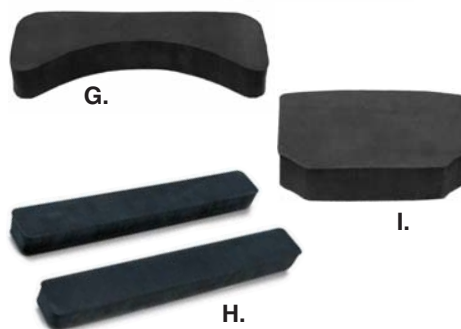

POLE SHOCK PADS

Protects engine hood from damage when handlepole is dropped. Color: Black only

Description	Part No.
G. Kaw 750SX/SXI/800SXR (1)	TS401
H. Kaw JS440/550/550SX (2)	TS411
I. Yamaha Super Jet (1)	TS421

FOUR STROKE
 INTAKE SYSTEMS
 ENGINE/GASKETS
 EXHAUST
 DRIVE LINE HANDLING
 ELECTRICAL
 WATERLINE /BILGE
 STEERING & CONTROLS
 BODY
 ACCESSORIES
 SERVICE TOOLS /HARDWARE
 CHEMICAL

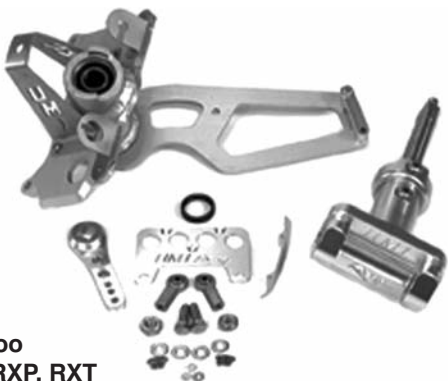

Sea-Doo
 GSX, RXP, RXT

UMI TOP STOP BILLET STEERING

Top stop steering for positive control and extraordinary strength. Improved handling by shifting weight to correct point on watercraft.

Description	Part No.
GSX, GTX, GTI, GTS, GSI, GS 96+, RX, RXP155/215, RXP-X255, RXT215, RXT-X255 (08-11)	SD-04804-GSX



Yamaha	Part No.
UMI Wave Blaster Billet Steering System	YA-04700-TS



Kawasaki	Part No.
UMI X-2 Billet Steering System	X2-04600-TS



REPLACEMENT BEARING KIT FOR UMI STEERING SYSTEMS

Description	Part No.
Replacement Bearing Kit For all Steering Systems except XP97+ (requires 2 kits)	58-6300



"DO SPEED" SPACER AND MOUNTING KIT FOR UMI RXP-X/RXT-X STEERING SYSTEMS

See page 28 for information and details.

Description	Part No.
"DO Speed" Spacer and Mount Kit for UMI RXP-X and RXT-X Steering System	D-X-P



RS24090-ICRT

RXP-X 260 PRO-SERIES STEERING SYSTEM

See page 28 for information and details.

Description	Part No.
RXP-X 260/300 Pro-Series Steering System	RS20110
RXP-X 260/300 (T3)	
Sea-Doo iControl Removal Tool	RS24090-ICRT

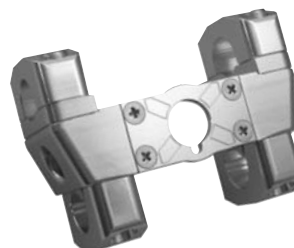

SPEED MAGIC "X MOUNT" STEERING HEAD

Description	Part No.
Speed Magic Steering Head	SE-027015



RIVA FZ PRO-SERIES STEERING SYSTEM

See page 55 for information and details.



Description	Part No.
RIVA FZ/FZS Steering System	RY20050-U-3.5
Tube Kit 5-1/2"	RY20050-RK-5.5
Tube Kit 7-1/2"	RY20050-RK-7.5



RIVA ULTRA PRO-SERIES STEERING SYSTEM

See page 70 for information and details.

Description	Part No.
RIVA Ultra 250/260/300 Steering System	RK20090-U-8.75
11.75" Tube Kit for RK20090	RK20090-RK-11.75



RIVA ULTRA PRO-SERIES STEERING LOWER

See page 70 for information and details.

Description	Part No.
RIVA Ultra Lower System Steering Assembly	RK20090-L



SE "SPEED MAGIC" FZR/FZS STEERING SYSTEM

This billet steering system is the ultimate upgrade for the new Yamaha FZ watercraft. The system is extremely strong and allows the rider to change to handlebars of their choice.

Description	Part No.
Sato Engineering FZR/FZS Steering System	SE-027020



ULTRA 250/260/300 AFTERMARKET BILLET HANDLEBAR ADAPTER

See page 71 for information and details.

Description	Part No.
Ultra 250/260/300 Billet Handlebar Adapter	DC-HA-KU



YAMAHA FZS/FZR/FZS SVHO BILLET HANDLEBAR ADAPTER

Description	Part No.
Yamaha FZS/FZR/FZS SVHO	SQ-HA-FZ



2015 IJSBA QUAKYSENSE WORLD FINALS
IN LAKE HAVASU CITY, ARIZONA.



EZ-TRIM SYSTEM (THE ORIGINAL)

Easy-Trim System was designed to allow riders of all levels to get a fair amount of trim with a light pull on the lever. The system will give you 30-35 degrees of trim. The system is constructed of anodized billet aluminum for strength and light weight. It can be changed into the straight pull with a few additional accessories. This system

is available for Yamaha Superjet or similar pump setups.

Kit includes: trim ring, cable, lever, hardware, reduction nozzle and steering nozzle. It is recommended that you purchase a through hull tube if your PWC is not equipped for a clean and easy installation.

EZ-Trim System	Color	Part No.
144mm Trim System	Black	TI-EZ-ORIG-144-BLK
144mm Trim System	Red	TI-EZ-ORIG-144-RED
144mm Trim System	Silver	TI-EZ-ORIG-144-SIL
Thrust Universal Replacement Trim Cable		TI-EZ-TRIM-CABLE



EZ FLO PRO TRIM UP FOR FREESTYLE/FREERIDE

- New thrust brand reduction nozzle and steering nozzle
- New thrust brand billet lever with cable

144mm	Part No.
Black	TI-EZ-FLO-144-BLK
Silver	TI-EZ-FLO-144-SIL
Red	TI-EZ-FLO-144-RED
Blue	TI-EZ-FLO-144-BLU
Green	TI-EZ-FLO-144-GRN
Orange	TI-EZ-FLO-144-ORG
Thrust Universal Replacement Trim Cable	TI-EZ-TRIM-CABLE

155mm	Part No.
Black	TI-EZ-FLO-155-BLK
Silver	TI-EZ-FLO-155-SIL
Red	TI-EZ-FLO-155-RED
Blue	TI-EZ-FLO-155-BLU
Green	TI-EZ-FLO-155-GRN
Orange	TI-EZ-FLO-155-ORG
Thrust Universal Replacement Trim Cable	TI-EZ-TRIM-CABLE



RRP TRIM SYSTEM

The RRP trim system is a super easy top pull trim system and was designed to be effortless and allowing for better rider control during maneuvers and tricks. The trim design features increased water flow while minimizing pressure loss during turning and trimming, this was

achieved with a all new trim ring design that features a tight clearance between the exit nozzle, the trim ring and the steering nozzle. The top pull mounting point on the trim ring is slotted to adjust the amount of trim the rider desires and creates the perfect rider feel.

Kit includes: reduction nozzle, steering nozzle, trim ring, cable, billet RRP lever and hardware. RRP trims are manufactured with thick exit and steering nozzles to allow for boring to larger sizes.

144mm	Part No.
Green	RRP-TRIM-144-GN
Silver	RRP-TRIM-144-SLV
Red	RRP-TRIM-144-RD
Black	RRP-TRIM-144-BLK
Blue	RRP-TRIM-144-BLU

155mm	Part No.
Green	RRP-TRIM-155-GN
Silver	RRP-TRIM-155-SLV
Red	RRP-TRIM-155-RD
Black	RRP-TRIM-155-BLK
Blue	RRP-TRIM-155-BLU

RRP TRIM SYSTEM REPLACEMENT PARTS

Description	Part No.
RRP Trim Cable	RRP-TRIM-CABLE
144mm Steering Nozzle	RRP-TRIM-NOZ-144
155mm Steering Nozzle	RRP-TRIM-NOZ-155



RRP NINJA PUMP FLOW GUARD

The RRP Ninja Flow Guard is a performance part that was designed by Ninja in Japan specifically for freestyle watercraft applications.

- Prevents the water flow to from the outside of the pump entering between the restriction nozzle and steering nozzle then breaking the flow water inside of the pump. Result: Loss of power
- Prevents back spray when turning the steering nozzle and loss of internal pump pressure. Result: Gain of power
- Stops the pumps to spray into the exhaust causing engine bog on acceleration during turning and maneuvers.

Tested and approved by Rick Roy, Rok Florjancik and Nac Florjancik.

144 MM Pump	Part No.
Carbon - 144 Yamaha	FL-GD-NIN1-CB (144-YAM)

155 MM Pump	Part No.
Carbon - 155 Yamaha	FL-GD-NIN1-CB (155-YAM)
Fiberglass -Black 155 Yamaha	FL-GD-NIN1-F-BLK (155-YAM)



UMI RACING TRIM LEVER

Billet Aluminum Trim Lever for Trim Tab and Quick Trim Nozzles.



Description	Part No.
Clear	KA-01525-CLR
Black	KA-01525-BLK



RRP BILLET TRIM LEVER

We tried and tested many shapes and styles of trim lever to suit the extreme riders needs. Produced from CNC machined 6061 T6 Aluminum. Ergonomically designed to fit the rider's fingers and also to give maximum pull on the cable. Trim cable adjuster is included.

Description	Part No.
Green	RRP-TRIM-LEVER-GN
Red	RRP-TRIM-LEVER-RD
Black	RRP-TRIM-LEVER-BLK
Blue	RRP-TRIM-LEVER-BLU



Blowision Trim Lever - Left hand operated trim lever for pump tilt or trim systems.

Description	Part No.
Silver	03-05-230
Black	03-05-231
Red	03-05-232
Blue	03-05-233
Green	03-05-234
Orange	03-05-235

BLOWSION BILLET ALUMINUM TRIM LEVER



RRP YAMAHA QUICK STEERING ADAPTER

This quick steering adapter fits the stock superjet nozzle. It will give you the option to play with the quickness of the steering from really aggressive to really smooth. It will also give you a lot more turning ratio for free style. RRP quick steering adapters are black

Description	Part No.
RRP Yamaha Quick Steering Adapter	QU-ST-YAM-BL



BLOWSION IZZNELL TWISTER NOZZLE

Available for all years Yamaha SuperJets. Allows additional throw on steering nozzle and multiplies the turning radius exponentially. A surf and freeride necessity!

Description	Part No.
Izznell Twister Nozzle Bracket only	02-02-417



HEAVY DUTY STAINLESS STEEL CABLE ENDS

Description	Part No.
M5 x 0.80 Stainless Steel Cable End	58-6335
M6 x 1.00 Stainless Steel Cable End	58-6336



Skat-Trak
Performance Products



SKAT-TRAK 5/8" TRIM TUBE SEAL/NIPPLE

This Skat-Trak seal seals the trim cable to the trim tube to prevent any water from entering the engine compartment via the trim tube. Hot Products recommends you use a seal on both ends of the tube. Sold individually.

Description	Part No.
5/8" Trim Tube Seal	SK TRIM SEAL

R&D AUTO DROP NOZZLE KITS & STEERING NOZZLE

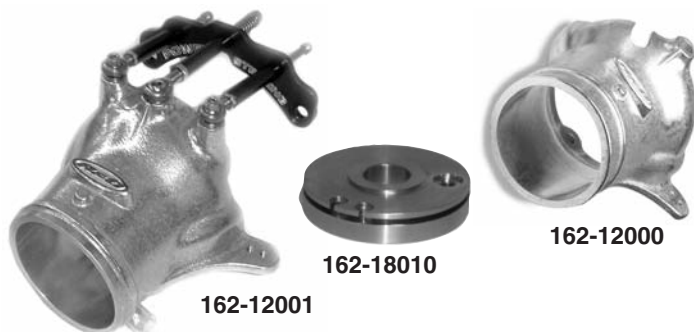

Yamaha	Part No.
GP1200R VTS Auto Drop Nozzle Kit	162-12001
GP1300R VTS Auto Drop Nozzle Kit	162-13000
FX-SHO (2008-12)/FX SVHO/FZ SVHO/FZR/FZS VXR/VXS Auto Trim Nozzle Kit	162-18020
FX SHO/FZR/FZS VTS Quick Shift Cam Kit	162-18010
GP 1200R / 1300R	162-12000
FX-SHO (2008-12)/FX SVHO/FZ SVHO/FZR/FZS Hydro Force Steering Nozzle	162-14000



Sea-Doo	Part No.
RXP 215 Auto Trim Kit	163-21502
RXP Holeshot Rod for use with #163-21502	162-21503
RXT 215/GTX 4-Tec Auto Trim Kit	163-95003
RXP-X 255/RXT-X 255 Auto Trim Kit	163-25500
RXP 215/RXP-X 255/RXT 215/RXP-X 255 Pro Steering Nozzle (+15mm)	163-21500



TRIM ROD/STEERING CABLE BALL JOINTS

Replaces OEM Ball Joint

Steering Cable Ball Joint	OEM#	Part No.
Sea-Doo 720/800/951/1503 (Fits the rear steering cable 1/4"-28 UNF thread (later/larger))	277000775	002-500
Sea-Doo 580/720/800/951 (Fits the rear steering cable 10-32 UNF thread (early/smaller))	277000153/277000037	002-502
Sea-Doo 720/800/951	277000646	002-503

Steering Cable Ball Joint	OEM#	Part No.
Sea-Doo 951 GSX (1998-99)	277000918	002-501
951 XP (1998-2002)		

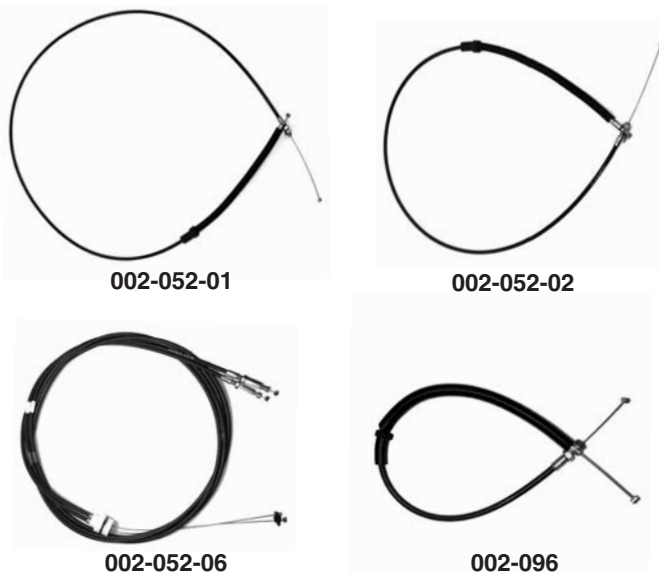

WSM REPLACEMENT TILT CABLES

YAMAHA	CC	YEAR	O.E. NO.	PART NO.
Wave Raider	700	1994-95	GH1-6153D-10-00	002-096
Wave Raider Deluxe	700	1995	GH1-6153D-00-00	
GP	760	1999-200	GP7-U153D-00-00	002-052-01
Wave Blaster	760	1997	GH1-6153D-00-00	002-096
Wave Raider	760	1996	GH1-6153D-10-00	
Wave Runner	760	1997-98	GP7-U153D-00-00	002-052-01
GP	800	1998-2000		
GP	800	2001-05	F0D-U153D-00-00	002-052-02
XL	800	2000-01	F0D-U153D-10-00	
XLT	800	2002-03	F0D-U153D-01-00	
FX	1000	2005-06	F1B-U153D-00-00	002-052-04
FX 140	1000	2002-04	F1B-U153D-01-00	
FX Cruiser	1000	2003-07		
FX Cruiser HO	1100	2004-07		
FX Cruiser HO	1100	2006		
Anniversary				
FX HO	1100	2004-07		
Wave Raider	1100	1995-96	GH1-6153D-00-00	002-096
			GH1-6153D-10-00	
GP	1200	1997-99	GP7-U153D-00-00	002-052-01
GP	1200	2000-02	F0D-U153D-00-00	002-052-02
SUV	1200	1999-2001	F0D-U153D-01-00	
SV	1200	2002-04	F0D-U153D-10-00	
XL	1200	1999-2001		
XLT	1200	2002-05		
GP	1300	2003-08		
FX	1800	2008	F1W-6153E-00-00	002-052-06
FX Cruiser	1800	2008	F1W-6153E-01-00	
FX Cruiser HO	1800	2008-11		
FX Cruiser Super HO	1800	2008-11		
FX HO	1800	2008-11		
FX Super HO	1800	2008-11		
FZR	1800	2009-15	F2C-6153E-00-00	002-052-05
FZS	1800	2009-15		



RRP ADJUSTABLE THROTTLE LEVER

This lever is adjustable in a second to fit the rider's finger size. Everyone has a preference when it comes to throttle finger, hand size is also a factor, that's why we designed one that can fit everyone. Ergonomically designed to give the rider a good grip and good feeling. Comes with Yamaha and Kawasaki stainless steel cable adaptors.

Description	Part No.
Green	RRP-TH-LEVER-GN
Red	RRP-TH-LEVER-RD
Black	RRP-TH-LEVER-BLK
Blue	RRP-TH-LEVER-BLU



THRUST INNOVATIONS BILLET THROTTLE LEVER

Thrust Innovation's new throttle lever is completely adjustable by loosening one allen bolt without removing the lever from the handlebars. The angle of the lever can be adjusted up or down to the riders exact preference. These levers are threaded Yamaha 6mm cables.

Description	Part No.
Black	TI-THR-LVR-YAM-BLK
Silver	TI-THR-LVR-YAM-SIL
Red	TI-THR-LVR-YAM-RED
Blue	TI-THR-LVR-YAM-BLU
Orange	TI-THR-LVR-YAM-ORG
Green	TI-THR-LVR-YAM-GRN

Thrust Kawasaki lever available Spring 2015. Call for details.



SE "SPEED MAGIC" TYPE 6 THROTTLE LEVER

Description	Color	Part No.
E. Long Lever	Silver	SE-002601
F. Long Lever	Black	SE-002609
G. Short Lever	Silver	SE-002611
H. Short Lever	Black	SE-002619



BLOWSION BILLET THROTTLE LEVER

Machined with the stand-up rider comfort at a premium, the new Blowson straight pull finger throttle levers are ergonomically designed for premium fit and feel whether you are on the waves or on the buoys. Lever angle is situated to reduce hand and arm fatigue. Delron bushings eliminate the play common in OEM throttle levers and provides a smooth throttle pull action. All stainless hardware at the hinge point eliminates corrosion and play 100%. No "C" clips are used in the throttle lever assembly.

Description	Part No.
Black	03-05-201
Blue	03-05-202
Green	03-05-204
Orange	03-05-205
Red	03-05-207
Clear	03-05-208

FOUR STROKE	INTAKE SYSTEMS	ENGINE/GASKETS	EXHAUST	DRIVE LINE HANDLING	ELECTRICAL	WATERLINE /BILGE	STEERING & CONTROLS	BODY	ACCESSORIES SERVICE TOOLS /HARDWARE	CHEMICAL
-------------	----------------	----------------	---------	---------------------	------------	------------------	---------------------	------	-------------------------------------	----------



HOT PRODUCTS THROTTLE CABLE ADAPTERS



New improved design,
aluminum and anodized silver

Description	Part No.
Cable Adapter for Kawasaki Pre-86, Yamaha & All Wet Jet 6mm Throttle Cable Kawasaki 440 (76-86), 550 (82-85), Yamaha All Models (87-00) Hydrospace S4	58-0990



Description	Part No.
Cable Adapter for Kawasaki 96+ 8mm Throttle Cable Kawasaki 750 SS-XI-SXI (96-00), 750 STS (95-97), ZXI (95-00), STX (97-00)	58-0991



Description	Part No.
Cable Adapter for All Sea-Doo	58-1996



HOT PRODUCTS ALUMINUM TRIGGER THROTTLE LEVERS

Fits 86-95 Kawasaki & Polaris.
10mm Throttle Cable Kawasaki 550 (86-95), 650 (86-95), 750 SX-SS-SXI
(92-95), 750 ST (94-95).
An adapter is required for: Sea-Doo, Yamaha and Kawasaki Pre 86 & 96+.

Description	Part No.
Silver	58-0970
Black	58-0971



YAMAHA SUPERJET REPLACEMENT EXTRA LARGE THROTTLE CABLE

Extra long OEM Yamaha
throttle cable is a must for
aftermarket handlepoles.
OEM# EUO-U7252-01-00

Description	Part No.
SuperJet X-Long Throttle Cable	05-0226



UMI BILLET FINGER THROTTLE

Lever perch is machined at an angle which makes the lever pull at a downward sloping angle. This motion keeps the lever at the tip of your finger throughout the throttle range greatly reducing arm pump and providing superb throttle control. Also available in traditional straight pull. Teflon bushings eliminate the play common in other throttles and provides a smoother throttle pull. Stainless steel pin and C-Clip eliminates corrosion at hinge point. Available for all models. Some models require a throttle cable adapter.



Straight Lever	Part No.
Silver	KA-01521-CLR
Black	KA-01521-BKA



Angled Lever	Part No.
Silver	KA-01520-CLR
Black	KA-01520-BKA



3 Cable Throw
Positions

Nylon Cable Roller

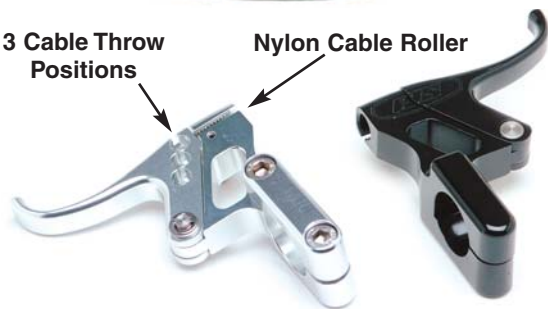

PJS BILLET THROTTLE LEVER

Billet constructed throttle features nylon cable roller, nylon bushing and thrust washers, 3 cable throw positions, 6mm stainless steel bolts. This lever is specially designed to contour around your index finger. The narrow lining allows you to gain quicker response on hole shots without your middle finger getting in the way of a full pull.

Description	Part No.
Silver	58-0981
Black	58-0982



RIVA RACING SEA-DOO BILLET FINGER THROTTLE

Specifically designed to match throttle travel of Sea-Doo 4-Stroke PWC. Direct replacement for bulky OEM throttle on X-Models and can be used with aftermarket bars on other 4-tec applications. Adjustable throttle angle & unique trigger design keeps the trigger at the tip of your finger throughout the throttle range for reduced arm pump & superb throttle control.



Delrin bushings eliminate play common in OEM throttles and provide smooth actuation. All stainless hardware at hinge point eliminates corrosion and play. No "C" clips used. Use with OEM adapter on X-Models or use aftermarket adapter (sold separately) for other 4-Tec applications.

Description	Part No.
RIVA Racing Billet Finger Throttle for Sea-Doo	RS24010P
*Available in clear finish only	

RIVA RACING YAMAHA & KAWASAKI BILLET FINGER THROTTLE

Ergonomically designed for premium fit and feel whether you are on the waves or turning buoys. Lever angle is fully adjustable to reduce hand and arm fatigue. Delrin bushings eliminate play common in OEM throttles and provide smooth actuation. All stainless



hardware at hinge point eliminates corrosion and play. No 'C' clips used. Available in anodized Clear or Black. Throttle cable adapter sold separately.

Description	Part No.
Clear Billet Finger Throttle for Yam/Kaw	RY24010P
Black Billet Finger Throttle for Yam/Kaw	RY24010B



TBM RACING HI PERFORMANCE ADJUSTABLE FINGER THROTTLE

Precision machined from aircraft grade aluminum featuring a bushing pivot, fully adjustable perch and ergonomically correct to reduce hand fatigue. Fully rebuildable design allows you to replace the pivot bearing extending the life of the throttle lever. Also available with a needle bearing pivot for the ultimate in precision ergonomics.

Description	Model	Part No.
A. Clear	Bushing	TBM118B-CLR
B. Black	Bushing	TBM118B-BLK
A. Clear	Bearing	TBM118BB-CLR
B. Black	Bearing	TBM118BB-BLK

SD RXP/RXT/RXP-X & Hydrospace	Model	Part No.
C. Clear	Bushing	TBM118-SH-CLR
D. Black	Bushing	TBM118-SH-BLK

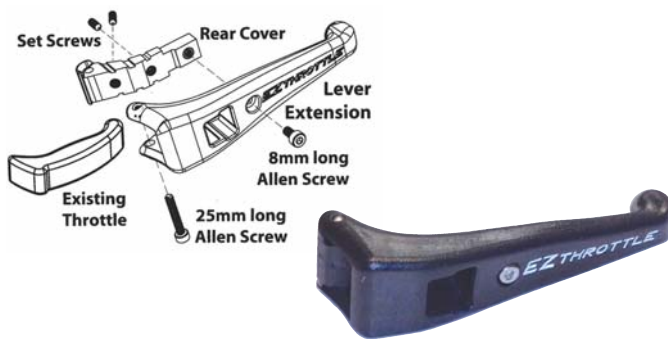

EZ-THROTTLE™ UNIVERSAL TRIGGER THROTTLE EXTENDER

EZ-Throttle Universal Trigger Throttle Extender works on any model PWC. With EZ-Throttle your trigger is longer, making it more comfortable and easier to use.

- Fits Yamaha, Sea-Doo and Kawasaki PWC with trigger throttles
- Designed to attach to the existing finger throttle already on your PWC
- Easy install. No disassembly required of existing throttle
- EZ-Throttle fits over and around existing trigger encasing it between two molded parts, forming a smooth comfortable trigger assembly
- Gives easier speed control for pulling tubes, wakeboards and water skiers
- Enjoy longer rides without hand cramps
- Injection molded plastic specially made for marine use
- Made with marine-grade plastic and stainless steel fasteners
- Does not interfere with full throttle

Description	Part No.
Universal Trigger Throttle Extender for PWC	EZT

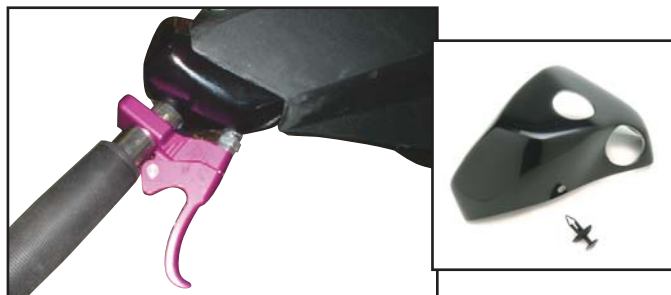

HANDLEBAR COVER CAP FOR SEA-DOO 4-TEC - RXP - RXT - GTX - GTI

Description	Part No.
Handlebar Cover Cap	FB001-SD



RIVA SEA-DOO HANDLEBAR EXTENSION SET

Allows easy installation of popular ODI 130mm grips. Sold as a pair, grips sold separately.

Description	Part No.
All 4-Tec (Except Spark)	RS24100-BES
Spark	RS24130-BES

FOUR STROKE

INTAKE SYSTEMS

ENGINE/GASKETS

EXHAUST

DRIVE LINE HANDLING

ELECTRICAL

WATERLINE /BILGE

STEERING & CONTROLS

BODY

ACCESSORIES

SERVICE TOOLS /HARDWARE

CHEMICAL



**LOCK-ON
GRIP SYSTEM™**

Easy Installation
No Grip Glue Required

Revolutionary Non-Slip Technology for the Wettest Environments on Earth
ROGUE LOCK-ON GRIPS (120MM) **RUFFIAN LOCK-ON GRIPS (120MM)**

ROGUE WATERCRAFT GRIPS

Soft

with 3/4 Flange



Grip Color	Clamp Color	Part No.
Black	Silver	L30RGB-S

RUFFIAN WATERCRAFT GRIPS

Hard Slim

with 3/4 Flange



Grip Color	Clamp Color	Part No.
Black	Silver	L30RFB-S

ROGUE LOCK-ON GRIPS (130MM)

ROGUE WATERCRAFT GRIPS

Soft



Grip Color	Clamp Color	Part No.
Black	Silver	L31RGB-S
Lime Green	Black	L31RGLG-B

RUFFIAN LOCK-ON GRIPS (130MM)

RUFFIAN WATERCRAFT GRIPS

Hard Slim



CROSS TRAINER LOCK-ON GRIPS (130MM)

Medium Soft Slim



Grip Color	Clamp Color	Part No.
Black	Black	L30CTB-B
Lime Green	Black	L30CTLG-B

RUFFIAN MX LOCK-ON GRIPS (130MM)

Medium Soft Slim



Grip Color	Clamp Color	Part No.
Black	Silver	L32RFB-S

Grip Color	Clamp Color	Part No.
Black	Silver	L31RFB-S
White	Black	L31RFW-B
Lime Green	Black	L31RFLG-B
Blue	Black	L31RFBU-B
Pink	Black	L31RFP-B
Purple	Black	L31RFPR-B
Red	Black	L31RFBR-B



TROY LEE DESIGNS GRIPS (130MM)



Grip Color	Clamp Color	Part No.
White	Red	L30TLW-R
Black	Grey	L30TLB-G
TLD Red	Black	L30TLR-B
Fluorescent Orange	Black	L30TLO-B
Pink	Black	L30TLP-B
Aqua	Blue	L30TLAQ-U
Bright Yellow	Grey	L30TLY-G



VANS LOCK-ON GRIPS (130MM)

Grip Color	Clamp Color	Part No.
Black	Black	L30VNB-B
Bright Red	Black	L30VNBR-B
White	Black	L30VNW-B
Limited Edition "Vans"	White/	L30VGR-W
Gum Colored	Checked	



SDG LOCK-ON GRIPS (130MM)

Grip Color	Clamp Color	Part No.
Black	Black	L30SDB-B
Bright Red	Black	L30SDBR-B
Lime Green	Black	L30SDLG-B
Aqua	Black	L30SDAQ-B

X-TREME ELEMENTS LOCK-ON GRIPS (130MM)



Grip Color	Clamp Color	Part No.
Graphite	Grey	L30XTH-G
Black	Black	L30XTB-B



White clamp not shown in this image.

ODI LOCK JAW CLAMPS

Includes black end cap with white ODI logo. 4 pieces per kit.

Description	Part No.	Description	Part No.
Black	L70LJB	Gold	L70LJD
Silver	L70LJS	Purple	L70LJP
Blue	L70LJU	Green	L70LJN
Red	L70LJR	White	L70LJW
Grey	L70LJG	Orange	L70LJO



ODI LOCK JAW REPLACEMENT BOLTS



These bolts are replacements for the specially designed allen bolts used with Lock Jaws and eliminates the need to buy an entire new set of clamps just to replace the bolts.

Description	Part No.
Lock Jaw Replacement Bolt Set (5 pcs/pk)	F70RSB



ODI BILLET ALUMINUM END PLUG

Fits most sized bars, Triple-Core Design Holds Plugs Inside Bars, Sold in pairs

Description	Part No.
Black	L71APB
Red	L71APR
Silver	L71APS
Blue	L71APU

FOUR STROKE
INTAKE SYSTEMS
ENGINE/GASKETS
EXHAUST
DRIVE LINE HANDLING
ELECTRICAL
WATERLINE /BILGE
STEERING & CONTROLS
BODY
ACCESSORIES
SERVICE TOOLS /HARDWARE
CHEMICAL

FOUR STROKE
 INTAKE SYSTEMS
 ENGINE/GASKETS
 EXHAUST
 DRIVE LINE HANDLING
 ELECTRICAL
 WATERLINE /BILGE
 STEERING & CONTROLS
 BODY
 ACCESSORIES
 SERVICE TOOLS /HARDWARE
 CHEMICAL



BLOWSION LOCK RING CAP SET

Blowson integrated the outside lock ring and the end cap into one piece for that special look. Each package contains two lock rings and two lock ring end caps.

Description	Part No.
Black	03-05-341
Blue	03-05-342
Clear	03-05-343
Green	03-05-345
Orange	03-05-346
Purple	03-05-347
Red	03-05-348



All Grip Kits Include Plastic End Caps



Plastic End Caps



Hot Product Logo Rings



LOEDS100



LOEDS200

Medium Soft Slim

EXPERT MACHINE GRIPS

Grip Color	Ring Color	Part No.
Black	Black	LOEDS100
White	Black	LOEDS200

ECONOMY GLUE-ON SINGLE PLY ODI GRIP



ODI O-GRIP (120 MM)

Description	Part No.
O-Grip, Black	D010GB



ODI GRIP GLUE

Description	Part No.
Grip Glue, 5 ml	H70GG
Grip Glue, 12 pack of 5 ml	H70GG-12



3BOND GRIP LOCK

A high strength adhesive specially formulated to keep grips in place without damaging the rubber. Ideal for Snowmobile, Motorcycle, ATV and Personal Watercraft

Description	Part No.
ThreeBond Grip Lock 30gm (Dealer)	TB1501C

Hard Slim

LOGO GRIPS

Grip Color	Ring Color	Part No.
Black	Black	LOLDS100
Red	Black	LOLDS500
Green	Black	LOLDS700



LOLDS100



LOLDS500



LOLDS700



All Grip Kits Include Plastic End Caps

Made in the U.S.A.



LOPDS100



LOPDS200



LODDS100



LODDS200



LOPDS300



LOPDS400

Medium
Soft
Slim

PEATY GRIPS

White grips come with anodized red and blue rings, graphite grips come with anodized red rings and black grips come with anodized graphite rings. Small diameter, 130mm.

Grip Color	Ring Color	Part No.
Black	Graphite	LOPDS100
White	Blue/Red	LOPDS200
Graphite	Red	LOPDS300
Blue	Gold	LOPDS400



LOCD100



LOCD200



LOCD550



LOCD700

Medium
Soft
Slim

CHARGER GRIPS

Your favorite grip now available as a lock-on grip. Small diameter, 130mm.

Grip Color	Ring Color	Part No.
Black	Black	LOCD100
White	Black	LOCD200
Pink	Black	LOCD550
Neon Green	Black	LOCD700

Hard
Slim

BEARCLAW GRIPS

Grip Color	Ring Color	Part No.
Black	Red	LODDS100
White	Red	LODDS200



LONDS010



LONDS030

Medium
Soft

NORTHSHORE GRIPS

This grip is great for people with large hands.

Grip Color	Ring Color	Part No.
Black	Graphite	LONDS010
Graphite	Black	LONDS030



LOMDS010



LOMDS040

Medium
Soft
Slim

MOAB GRIPS

Grip Color	Ring Color	Part No.
Black	Black	LOMDS010
Black	Blue	LOMDS040

FOUR STROKE	INTAKE SYSTEMS	ENGINE/GASKETS	EXHAUST	DRIVE LINE HANDLING	ELECTRICAL	WATERLINE /BILGE	STEERING & CONTROLS	BODY	ACCESSORIES	SERVICE TOOLS /HARDWARE	CHEMICAL
-------------	----------------	----------------	---------	---------------------	------------	------------------	---------------------	------	-------------	-------------------------	----------



YOUR STYLE, YOUR COLOR, YOUR CHOICE
All custom, handmade. You may have only one of your own Jettrim covers.

JETTRIM CUSTOM ORDER SEAT COVERS

Three Easy Steps to Order a Custom Jettrim Seat Cover

1. Locate the seat cover template in the Hot Products website www.HotProductsUSA.com.*
2. Write the information of the colors & materials (see pg 272) you want on the seat cover template.
3. Fax or email the completed seat cover template.**

* If you are unable to find the seat cover template for your model, please contact us for assistance.

** It may take 7-10 working days to get your custom seat cover after we receive your completed custom seat cover template.

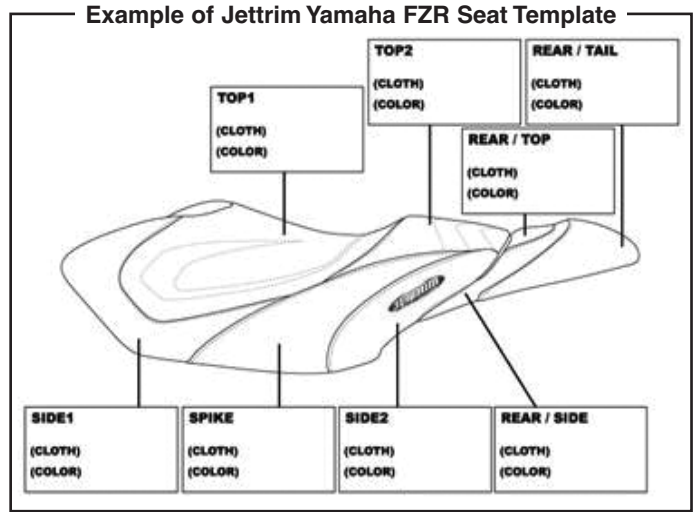

Pricing, manufacturing and shipping time varies. • Please call for details and pricing based on your customized design
 The color swatches presented here are for reference only, the exact color may vary.

SMOOTH GRAIN VINYL • FOR THE SIDE OR TAIL OF THE SEAT



DIAMOND PLATE & DOTS

• FOR THE TOP OR SIDE



DIAMOND • FOR THE SIDE OR TAIL



WAVE VINYL • FOR THE SIDE OR TAIL



BASKET

• FOR THE TOP OR SIDE



PIGSKIN

• FOR THE TOP OR SIDE

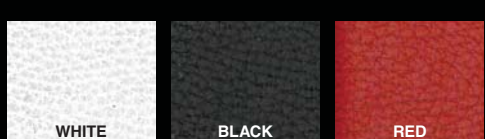

GEAR

• FOR THE SIDE OR TAIL

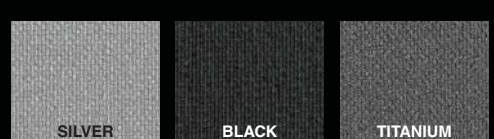

FOUR STROKE
INTAKE SYSTEMS
ENGINE/GASKETS
EXHAUST
DRIVE LINE HANDLING
ELECTRICAL
WATERLINE /BILGE
STEERING & CONTROLS
BODY
ACCESSORIES
SERVICE TOOLS /HARDWARE
CHEMICAL



FOR THE TOP OF THE SEAT





JETTRIM CUSTOM SEAT COVERS FOR SEA-DOO

FOUR STROKE
INTAKE SYSTEMS
ENGINE/GASKETS
EXHAUST
DRIVE LINE HANDLING
ELECTRICAL
WATERLINE /BILGE
STEERING & CONTROLS
BODY
ACCESSORIES
SERVICE TOOLS /HARDWARE
CHEMICAL

Sea-Doo	Part No.
HX SPIKE DESIGN 3-color	SDHX101
HX RETRO DESIGN 4-color	SDHX103
Spark (14) 2-Seater	SDS101-2
Spark (14) 3-Seater	SDS101-3
SPX (94-99) FLAT	SDSPX101
SPX (94-99) HUMP (not pictured)	SDSPX106
GX (97-01), GSX (96-99) (not pictured)	SDGSX101
XP (XPL) (97-04)	SDXP101
XP (XPL) (97-04) NEW DESIGN	SDXP103
GTX (96-99), GTI (97-00)	SDGTX101
GTX (03-06) RXT(X)215(07-09) Standard Design	SDRXT101
GTX/RXT/4TEC RETRO DESIGN (03-09) RXT(X)215 (07-09)	SDRXT104

Sea-Doo	Part No.
RXT 260 (10-13), RXT-X 260 (10-15), RXT-iS (09-12), RXT-X aS 260 (12-15), Wake 215	SDRXTXIS101-1
GTX Ltd iS (09-15), GTX 155/215 (12-15)	SDRXTXIS101-2
GTR 215 (12-16), GTI SE 130/155, GTI Ltd 155 (12-16)	SDRXTXIS101-3
GTS 130, GTI 130 (11-16), Wake 155 (12-16)	SDRXTXIS101-4
GTX (00-02)	SDGTX105
GTX (07-09), GTX Ltd (08) not iS	SDGTX107
RXP / 215 (04-08)	SDRXP101
RXP-X (08-11)	SDRXPX101
RXP-X (08-11) HUMP (not pictured)	SDRXPX101H
RXP-X (08-11) RETRO	SDRXPX102
RXP-X 260 (12-14) SPIKE	SDRXPX103
RXP-X 260 (12-14) RETRO	SDRXPX103R

**Call for all the most up-to-date 2016 models*



Sea-Doo **Part No.**
Spark 2-Seater **SDS101-2**



Sea-Doo **Part No.**
Spark 3-Seater **SDS101-3**



Sea-Doo **Part No.**
RXP-X 260 **SDRXPX103R**
2012+ Retro Design



Sea-Doo **Part No.**
RXP-X260 **SDRXPX103**
2012+ Spike Design



Sea-Doo **Part No.**
RXP-X **SDRXPX101**
(2008-11) Spike Design



Sea-Doo **Part No.**
RXP-X **SDRXPX102**
(2008-11) Retro Design



Sea-Doo **Part No.**
RXP 215 (04-08) **SDRXP101**



Sea-Doo **Part No.**
SDRXTXIS101-1/2/3/4
**See above for applications*



Sea-Doo **Part No.**
GTX/RXT **SDRXTX103**
4-Tec Retro Design (03-09)
RXT(X)215(07-09)



Sea-Doo **Part No.**
GTX (03-09) **SDRXT101**
RXT(X)215(07-09) Standard Design



Sea-Doo **Part No.**
GTI (2004) **SDGTI101**
Retro Design



Sea-Doo **Part No.**
GTX (2000-02) **SDGTX105**



Sea-Doo **Part No.**
GTX (1997-99) **SDGTX101**



Sea-Doo **Part No.**
RX/RXX **SDRX101**



Sea-Doo **Part No.**
XP/XPL (1997-2002) **SDXP101**
4-Color Design



Sea-Doo **Part No.**
XP/XPL (2003-05) **SDXP103**
4-Color Design



Sea-Doo **Part No.**
XP/XPL **SDXP105**
Spike Design



Sea-Doo **Part No.**
SPX/XP (93-99) **SDSPX101**
Flat Seat



Sea-Doo **Part No.**
HX **SDHX103**
Retro 4-Color Design



Sea-Doo **Part No.**
HX **SDHX101**
Spike 3-Color Design



JETTRIM CUSTOM SEAT COVERS FOR KAWASAKI

Kawasaki	Part No.
Ultra 250, LX (07-08), 260X (09-10), 300X (11-13), 310X (14-16) Spike Design	KU250X101
Ultra 250, LX (07-08), 260X (09-10), 300X (11-13), 310X (14-15) Retro Design	KU250X104
Ultra LX (10-12), 250/260/300/310LX (09-16) Cruiser	KU300LX101
310R & 310X SE (14-16)	KU310101
STX 1100 (00-02)	K15F101
STX-12F (06-11), STX-15F (06-14)	K15F102

Kawasaki	Part No.
1200STX-R/15F (02-05), STX (03-05), 900STX (06), STX (12)	KSTXR101
STX1100 (97-99), STX900 (99-00), STS900 (01-02)	KSTX101
Ultra 150	KU150101
ZXI	KZXI101
750SS, 750X1	KX101
650 X-2	KX2101

**Call for all the most up-to-date 2016 models*



Kawasaki **Part No.**
Ultra 250X **KU250X101**
260X/300X/310X Spike Design



Kawasaki **Part No.**
Ultra 250X **KU250X104**
260X/300X/310X Retro Design



Kawasaki **Part No.**
Ultra LX (2010-12) **KU300LX101**
250/260/300/310LX Cruiser



Kawasaki **Part No.**
Ultra 310R **KU310101**
310XSE (2014-16)



Kawasaki **Part No.**
STXR **KSTXR101**
15F (02-05), STX (03-05),
900 STX (06), STX (12)



Kawasaki **Part No.**
STX-15F (06-14) **K15F102**
STX-12F (06-11)



Kawasaki **Part No.**
Ultra 150 **KU150101**



Kawasaki **Part No.**
STX 1100 (00-02) **K15F101**



Kawasaki **Part No.**
STX 1100 (97-99), **KSTX101**
STS 900 (01-02),
STX 900 (99-00)



Kawasaki **Part No.**
ZXI **KZXI101**



Kawasaki **Part No.**
750SS, 750X1 **KX101**



Kawasaki **Part No.**
650 X-2 **KX2101**



ROSS WALLACH OF RPM RACING PRESENTS KELLY HART WITH A TROPHY HONORING JETTRIM'S FOUNDER GARY HART AT THE 2015 GARY HART MEMORIAL IJSBA LAKE HAVASU OPEN OF WATERCROSS RACING. THIS RACE WAS ROUNDS 1 & 2 OF THE JETTRIBE BEST OF THE WEST RACING SERIES.



GARY "SUPER G" HART AND KELLY HART – GARY'S LEGACY AND CONTRIBUTIONS TO THE PWC INDUSTRY WILL NEVER BE FORGOTTEN.

FOUR
STROKE
INTAKE
SYSTEMS
ENGINE/
GASKETS
EXHAUST
DRIVE LINE
HANDLING
ELECTRICAL
WATERLINE
/BILGE
STEERING
& CONTROLS
BODY
ACCESSORIES
SERVICE TOOLS
/HARDWARE
CHEMICAL



JETTRIM CUSTOM SEAT COVERS FOR YAMAHA

FOUR STROKE
INTAKE SYSTEMS
ENGINE/GASKETS
EXHAUST
DRIVE LINE HANDLING
ELECTRICAL
WATERLINE /BILGE
STEERING & CONTROLS
BODY
ACCESSORIES
SERVICE TOOLS /HARDWARE
CHEMICAL

Yamaha	Part No.
Wave Blaster 1	YBL101
Wave Blaster 800	YWB101
Wave Blaster II (not pictured)	YWB2101
GP (98-00) 2-Piece Seat Cover (not pictured)	YGP101
GP 800R (01-04), 1200R (00-02), GP 1300R (03-08) (not pictured)	YGPR101
GP 800R (01-04), 1200R (00-02), GP 1300R (03-08) Spike Design	YGPR101R
GP 800R (01-04), 1200R (00-02), GP 1300R (03-08) Retro Design	YGPR104
FX 140 (02-04), FX (05-08), FX HO (06-08) Spike Design	YFX140101
FX 140 (02-04), FX (05-08), FX HO (06-08) Retro Design	YFX140102
FX SHO (08-11) Seat Cover	YSHO101

Yamaha	Part No.
FX SHO/FX HO (12-13), SVHO (14-15)	YFXSHO101
FX Cruiser HO/SHO (12-13) / SVHO (14)	YFXC101
FZR (09-11) Spike Design	YFZR101
FZR (09-11) Retro Design	YFZR102
FZR (12-14) Retro Design	YFZR105
FZS (09-14) Retro Design	YFZS101
FZS (09-14) Spike Design	YFZS102
VXR (11-14)	YVXR101
VXR (15-16)	YVXR103
VX Deluxe (10-12), VX Sport (11-14), V1 & V1 Sport (15) (not pictured)	YVX110101
VX Deluxe (10-12), VX Sport (11-14), V1 & V1 Sport (15) New Design (not pictured)	YVX110102

**Call for all the most up-to-date 2016 models*



Yamaha Part No.
FZR (12-16) **YFZR105**



Yamaha Part No.
FZR (09-11) Spike Design **YFZR101**



Yamaha Part No.
FZR (09-11) Retro Design **YFZR102**



Yamaha Part No.
FZS (09-16) Retro Design **YFZS101**



Yamaha Part No.
FZS (09-16) Spike Design **YFZS102**



Yamaha Part No.
VXR (11-14) **YVXR101**



Yamaha Part No.
VXR (15-16) **YVXR103**



Yamaha Part No.
SVHO (14-16), FX SHO/FX HO (12-13) **YFXSHO101**



Yamaha Part No.
FX SHO (08-11) **YSHO101**



Yamaha Part No.
FX Cruiser HO/SHO (12-13), SVHO (14) **YFXC101**



Yamaha Part No.
FX Cruiser HO/FX (14-16), FX Cruiser SVHO (15-16) **YFXC103**



Yamaha Part No.
FX 140 (02-04), FX HO (06-08) Spike Design **YFX140101**



Yamaha Part No.
FX 140 (02-04), FX HO (06-08) Retro Design **YFX140102**



Yamaha Part No.
GP 800R (01-04), GP 1200R (00-02), GP 1300R (03-08), 4-Color Spike Design **YGPR104**



Yamaha Part No.
Wave Blaster 800 **YWB101**



Yamaha Part No.
Wave Blaster **YBL101**



JETTRIM MATS & CHIN PAD COVERS FOR YAMAHA SUPER-JET

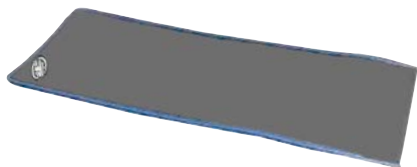

Yamaha	Part No.
SJ 96+ Bottom Mat Bump Stitch	YSJ103-B
SJ 96+ Bottom Mat Cross Stitch	YSJ103-C



YSJ126

Yamaha	Part No.
SJ 96+ Bottom & Side Mat with Lifter 3-Piece Kit (Over the Top)	YSJ126
SJ 96+ Bottom & Side Mat with Lifter 3-Piece Kit (Stock)	YSJ102



A.



B.

Yamaha	Part No.
A. SJ 96+ Chin Pad Cover 4-Color Design	YSJ124
B. SJ 96+ Chin Pad Cover 3-Color Design	YSJ123



Hydrospace	Part No.
Hydrospace S4 8-Piece Mat Set	HS101

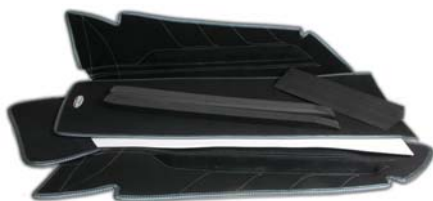

RRP Handlepole	Part No.
Custom Chin Pad for RRP Handlepole	JTRRP101



Yamaha	Part No.
SJ96+ Dash Pad	YSJ121



JETTRIM MATS FOR RUNABOUT

**Call for all the most up-to-date 2016 models*



Kawasaki	Part No.
Bottom Mat Kit 250X/260X/300X	KU250X102



Kawasaki	Part No.
Side Mats 250X/260X/300X	KU250X107



Yamaha	Part No.
FZR/FZS Side Mat	YFZR106



Yamaha	Part No.
FZS 3 Piece Bottom Mat	YFZS103

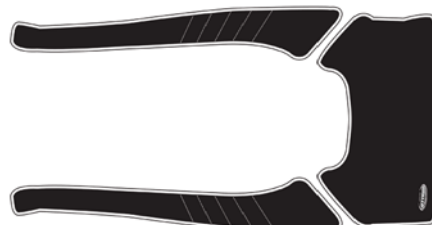

Yamaha	Part No.
SHO/HO 2012+ 3 Piece Mat Set	YSHO/HO101



Yamaha	Part No.
VXR/VXS Bottom Mat Kit	YVXR102

FOUR STROKE	INTAKE SYSTEMS	ENGINE/ GASKETS	EXHAUST	DRIVE LINE HANDLING	ELECTRICAL	WATERLINE /BILGE	STEERING & CONTROLS	BODY	ACCESSORIES	SERVICE TOOLS /HARDWARE	CHEMICAL
----------------	-------------------	--------------------	---------	------------------------	------------	---------------------	------------------------	------	-------------	----------------------------	----------

FOUR STROKE
 INTAKE SYSTEMS
 ENGINE/GASKETS
 EXHAUST
 DRIVE LINE HANDLING
 ELECTRICAL
 WATERLINE /BILGE
 STEERING & CONTROLS
 BODY
 SERVICE TOOLS ACCESSORIES
 SERVICE TOOLS /HARDWARE
 CHEMICAL

JETTRIM MATS FOR KAWASAKI

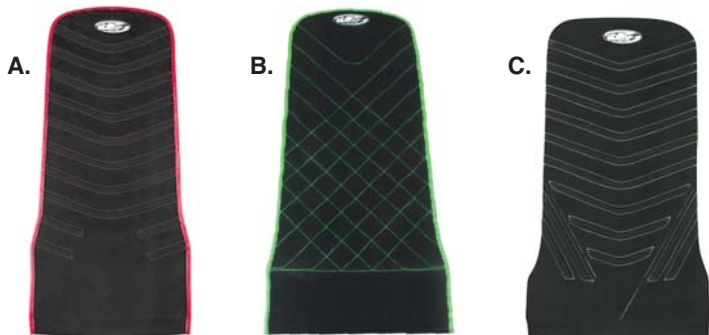

Bump Stitch Cross Stitch

Kawasaki	Part No.
A. 800 SXR Bottom Mat Bump Stitch	KSXR101-A
B. 800 SXR Bottom Mat Cross Stitch	KSXR101-C
C. 800 SXR Bottom Mat Bump Stitch for ERGO kick	KSXR101-EB
800 SXR Bottom Mat Euro Stitch (not pictured)	KSXR101-E

* Longer mat for kick tail is available as an option. Please specify when ordering.



For Aftermarket Rail

Kawasaki	Part No.
800 SXR Side Mat with Lifter	KSXR106-A
800 SXR Side Mat without Lifter	KSXR106-B
800 SXR Side Mat with Split Lifter	KSXR106-C
800 SXR Side Mat with Kick Tail Lifter	KSXR106-K

*Side mat is sold in pairs. Photos show one side only.



For OEM Rail

Kawasaki	Part No.
800 SXR Side Mat with Lifter	KSXR102-A
800 SXR Side Mat without Lifter	KSXR102-B



Full Mat Kit for Aftermarket Rail

Kawasaki	Part No.
800 SXR 7 Pcs Mat Kit	KSXR1111
Kit Includes: Dash, Side Mats (2), Bottom Mat, Rail Caps (2) and Kicker.	
800 SXR 5 Pcs Mat Kit	KSXR1113
Kit Includes: Dash, Side Mats (2), Bottom Mat, and Kicker. (No Rail Caps)	



Full Mat Kit for OEM Rail

Kawasaki	Part No.
800 SXR 4 Pcs Mat Kit	KSXR1112
Kit Includes: Dash, Side Mats (2) & Bottom Mat	

*Side lifters available, additional fee will apply.



Kawasaki	Part No.
800 SXR 4 Color Chin Pad Cover	KSXR108-4
800 SXR 3 Color Chin Pad Cover	KSXR108-3
800 SXR Dash Mat	KSXR109
800 SXR Pocket Dash Mat	KSXR1114

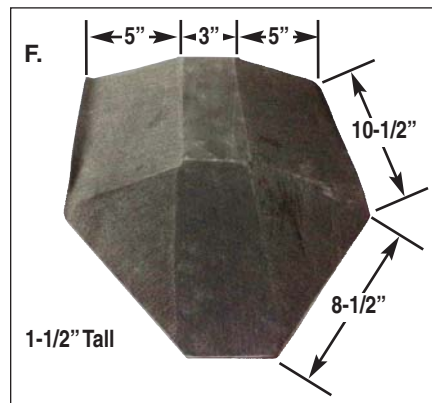
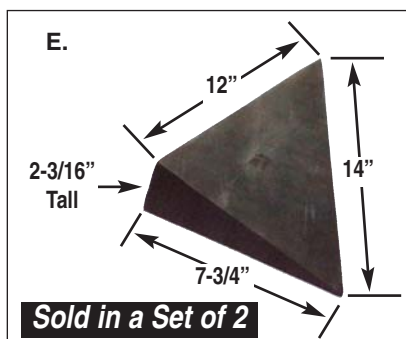
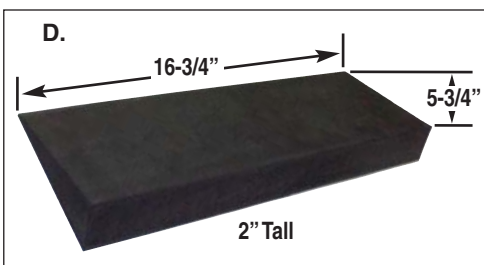

Kawasaki	Part No.
D. Kicker	MISC-KICKER
Cut Kicker (For use of boweye)	MISC-KICKER1
Straight Front Kicker	MISC-KICKER2
E. Ergo Kicker (Set of 2)	MISC-JT500
F. Large Front Hump	MISC-JT600
Small Front Hump	MISC-JT601
Under Mat	MISC-UNDERMAT

HYDRO-TURF PRE-COLORED SEAT COVERS

New for 2016, Hydro-Turf now has 2 pre-selected seat cover color options for simple and fast ordering.

Option A: The basic cover utilizing black vinyl and black carbon fabrics, to order a basic cover change the part number designation to "-A" (example: SEW74-A)

Option B: Color upgraded cover features pre-selected colors that compliment the PWC as you will see in the images listed below, these colored seat covers have the part designation that ends with "-B" (example: SEW74-B)

Option C: This is a total custom seat cover that your customer will select, colors and fabrics per the Hydro-Turf seat templates, for this option the part number will not have the ending part number designation (example: SEW74)

Yamaha	Part No.
WaveRunner 500 & 650 (not pictured)	SEW70
SUV (not pictured)	SEW72
WaveRunner III (not pictured)	SEW73
WaveBlaster	SEW74
WaveBlaster II	SEW741
WaveBlaster 800	SEW742
WaveRaider	SEW76
VXR (Pre 2011) (not pictured)	SEW77
WaveVenture (1994-96)	SEW78
WaveVenture (1997-98)	SEW781
XL1200 (1998) / XL700 & 760 (1998-2004)	SEW782
XL1200 Limited (1999-2000) / XL800 (2000-01)	SEW784
XL1200 (2001-05) / XLT800 (2002-04)	SEW785
GP Family (Pre 1999) / GP1200R (1999)	SEW79
GP800R (2001-02) / GP1200R (2000-02)	SEW791
GP1300R (2003-08) / GP800R (2003-04)	SEW792
FX (2002-04) / FX HO (2005-11)	SEWFX
FX SHO (2008-11)	SEWFX1
FX HO & FX SHO (2012-16) /	SEWFX11
FX SVHO (2014-16) (not pictured)	
FX Cruiser SHO (2008-09)	SEWFX1C

Yamaha	Part No.
FX Cruiser SHO (2010-11)	SEWFX1C-T
FX Cruiser (2003-04)	SEWFXC
FX Cruiser HO (2005-08)	SEWFX2
FX Cruiser HO (2009-11)	SEWFX2-V
FX Cruiser HO & FX Cruiser SHO (2012-13)	SEWFX21
FX Cruiser Ho & FX Cruiser SHO (2014-16)	SEWFX22
FX Cruiser SVHO (2015-16) (not pictured)	
FZR (2009-11)	SEWFZR
FZR (2012-16)	SEWFZR1
FZS (2009-16)	SEWFZS
VX (2005-09) / VXS,DLX & SPT (2010)	SEWVX
VXS, VX Deluxe & VX Sport (2011-14)	SEWVX1
V1 & V1 Sport (2015-16)	
VX, VXS, VX Deluxe (2015-16)	SEWVX2
VX Cruiser (2006-09)	SEWVXC
VX Cruiser (2010-14) (not pictured)	SEWVXC1
VX Cruiser (2015-16) / VX Cruiser HO /	SEWVXC2
VX Limited (2016) (not pictured)	
VXR (2011-14)	SEWVXR
VXR (2015-16)	SEWVXR1

*CF indicates Carbon Fiber-look material



Black/White

Yamaha Part No.
Waveblaster SEW74-B



Black/Black CF*/White

Yamaha Part No.
Waveblaster II SEW741-B



Royal Blue/Yellow

Yamaha Part No.
WaveRaider SEW76-B



Purple/White

Yamaha Part No.
WaveVenture (94-96) SEW78-B



Purple/White

Yamaha Part No.
WaveVenture SEW781-B
(97-98)



Black/White

Yamaha Part No.
XL 1200 (98) SEW782-B
XL700 & 760 (98-04)



Black/White

Yamaha Part No.
XL 1200 Limited (99-00), XL800 (00-01) SEW784-B



Black/Silver CF*

Yamaha Part No.
XLT 1200 (01-05) SEW785-B
XLT800 (02-04)



Black/Silver CF*

Yamaha Part No.
GPFamily (pre 99) SEW79-B
GP1200R(99)



Black/White/Deep Blue

Yamaha Part No.
GP800R (01-02) SEW791-B
GP1200R(00-02)



Black/Silver CF*

Yamaha Part No.
GP1300R (03-08) SEW792-B
GP800R (03-04)



Black/Silver CF*

Yamaha Part No.
FX (02-04) SEWFX-B
FX HO (05-11)



Black/Dark Grey CF*

Yamaha Part No.
FX SHO (08-11) SEWFX1-B



Black/Silver CF*

Yamaha Part No.
FX Cruiser SHO SEWFX1C-B
(08-09)



Black/Silver CF*

Yamaha Part No.
FX Cruiser SHO SEWFX1C-TB
(10-11)



White/Black

Yamaha Part No.
FX Cruiser SEWFXC
(03-04)

*CF indicates Carbon Fiber-look material

FOUR STROKE
INTAKE SYSTEMS
ENGINE/GASKETS
EXHAUST
DRIVE LINE HANDLING
ELECTRICAL
WATERLINE /BILGE
STEERING & CONTROLS
BODY
ACCESSORIES
SERVICE TOOLS /HARDWARE
CHEMICAL

HYDRO-TURF PRE-COLORED SEAT COVERS • YAMAHA (continued)

FOUR
STROKE



Black/Silver CF*

Yamaha Part No.
FX Cruiser HO SEWFX2-B
(05-08)



Black/Dark Grey CF*

Yamaha Part No.
FX Cruiser HO SEWFX21-B
& FX Cruiser SHO (12-13)



Black/Dark Grey CF*

Yamaha Part No.
FZR (12-16) SEWFZR1-B



Black/Dark Grey CF*

Yamaha Part No.
FZR (09-11) SEWFZR-B

INTAKE
SYSTEMS



Black/Silver CF*

Yamaha Part No.
VX (05-09) SEWVX-B
VXS, DLX & SPT (10)
(Not VXR)



Black/Silver CF*

Yamaha Part No.
VX Cruiser (06-09) SEWVXC-B



Black/Dark Grey CF*

Yamaha Part No.
FZS (09-16) SEWFZS-B



Black/Silver CF*

Yamaha Part No.
VX, VXS,
VX Deluxe (15-16) SEWVX2-B

ENGINE/
GASKETS

EXHAUST



Black/Silver CF*

Yamaha Part No.
VXS, VX Deluxe SEWVX1-B
VX Sport (11-14)
V1 & V1 Sport (15-16)



Black/Black CF*/Silver CF*

Yamaha Part No.
VXR (15-16) SEWVXR1-B



Black/Orange

Yamaha Part No.
VXR (11-14) SEWVXR-B

DRIVE LINE
HANDLING

ELECTRICAL

WATERLINE
/BILGE

STEERING
& CONTROLS

BODY

SERVICE TOOLS
ACCESSORIES

/HARDWARE

CHEMICAL

HYDRO-TURF PRE-COLORED SEAT COVERS • KAWASAKI

Kawasaki	Part No.
TS	SEW21
X2	SEW40
X2 (06-08)	SEW41
ZXi (95-97)	SEW60
ZXi 1100 (98-03) Seat + Cowling	SEW601
Ultra 150 / 130 DI Seat + Handlebar Pad	SEW61
Ultra 250 / LX (07-08) / 260X (09-13) / 300X (11-14) / 310X (14-16)	SEW62
Ultra 260 LX (10-12) / Ultra LX, 250 LX, 300 & 310 LX (11-16)	SEW62C
310 R & 310X SE (14-16)	SEW621

Kawasaki	Part No.
ST /STS / 750STX & 900STX (Pre 99)	SEW63
1100STX (97) / 900STX (99-00) / 900STS (01-02) Seat + Cowling	SEW631
1100STX (98-99)	SEW632
1100STX DI (00-02) / 900STX (01-02)	SEW64
STX-12F (06-11) / STX-15F (06-16)	SEW641
1200STX-R (02-05) / STX (03-05) / 900STX (06) / STX (12-13)	SEW64R
650SX Kit (2 sides, dash, 2 corners)	SEW65K
750SS / Xi	SEW66

*CF indicates Carbon Fiber-look material



Black Vinyl/Black CF*/Silver CF*

Kawasaki Part No.
Ultra 260 LX (10-12) SEW62C-B
Ultra LX, 250 LX, 300
& 310 LX (11-16) Cruiser



Black/Silver CF*

Kawasaki Part No.
Ultra 250 / LX (07-08) SEW62-B
260X (09-13) / 300X (11-14)
310X (14-16)



Black/Lime Green

Kawasaki Part No.
Ultra 310R SEW621-B
Ultra 310XSE (14-16)



Black/White/Dark Grey

Kawasaki Part No.
1100STX DI (00-02) SEW64-B
900 STX (01-02)



Black/White/Grey

Kawasaki Part No.
1100STX (98-99) SEW632-B



Black CF*/White

Kawasaki Part No.
X2 SEW40-B



Black CF*/Lime Green

Kawasaki Part No.
1200STX-R (02-05) SEW64R-B
STX(03-05)/900STX(06)/STX(12-13)



Red/Black/Silver CF*

Kawasaki Part No.
STX-12F (06-11) SEW641-B
STX-15F (06-15)

*CF indicates Carbon Fiber-look material

HYDRO-TURF PRE-COLORED SEAT COVERS • SEA-DOO

Sea-Doo	Part No.
XP (Pre 93) / SP (Pre 94)	SEW80
SPARK (14-16) 2 Seater (not pictured)	SEW81
SPARK (14-16) 3 Seater (not pictured)	SEW811
GT Family (90-95) / GTS (96-00) / GTI (96)	SEW82
GTX (96-99) / GTI (97-00)	SEW821
GTX (00-02)	SEW822
GTI (01-05) / GTS (01)	SEW823
GTI 4-Tec (06-08), GTI 130 (10)	SEW824
XP (93-96) / SP Family (94-99)	SEW83
GS/GSX	SEW831
XP (97-04)	SEW84
LRV (not pictured)	SEW85
RX / RXX (not pictured)	SEW86
HX	SEW87
GTX Di (02-03) / GTX 4-Tec (02-06) / RXT (05-06)	SEW88
GTX Ltd / GTX Wake (06-08) / Wake Pro 215 (09)	

Sea-Doo	Part No.
GTX (07-09) GTX Limited (08) Non IS	SEW881
Wake Pro 215 (10-15) / RXT-X aS 260 (12-15)	SEW882
GTX Ltd iS (09-15) / GTX 155 / GTX 215 (10-15)	SEW883
GTS 130 / GTI 130 (11-16) / Wake 155 (12-16)	SEW884
GTR 215 / GTI SE 130 / GTI SE 155 / GTI Ltd 155 (12-16)	SEW885
RXT-X 300, RXT-X aS 260, RXT 260, Wake Pro 215 (16) (not pictured)	SEW886
GTX Ltd 215, GTX Ltd 300, GTS Ltd iS 260, GTX 155, GTX s 155 (16) (not pictured)	SEW887
RXP / 215 (04-08)	SEW89
RXP-X (04-11)	SEW891
RXP-X 260 (12-15), RXP-X300 (16)	SEW892

*CF indicates Carbon Fiber-look material



Purple/Silver CF*

Sea-Doo	Part No.
XP (Pre 93)	SEW80-B
SP (Pre 94)	



Purple/White

Sea-Doo	Part No.
GT Family (90-95)	SEW82-B
GTS (96-00) / GTI (96)	



White/Dark Grey CF*

Sea-Doo	Part No.
GTX (96-99)	SEW821-B
GTI (97-00)	



Black/White

Sea-Doo	Part No.
GTX (00-02)	SEW822-B



Black/White

Sea-Doo	Part No.
GTI (01-05) / GTS (01)	SEW823-B



Black/Black CF*/Yellow/White

Sea-Doo	Part No.
GTI 4-Tech (06-08)	SEW824-B



Black/Black CF*/Grey/White

Sea-Doo	Part No.
XP (93-96)	SEW83-B
SP Family (94-99)	



Black/Red CF*

Sea-Doo	Part No.
GS / GSX	SEW831-B



Black CF*/Dark Grey CF*/Yellow

Sea-Doo	Part No.
XP (97-04)	SEW84-B



Black/Yellow/White

Sea-Doo	Part No.
HX	SEW87-B



Silver CF*/Black

Sea-Doo	Part No.
GTX Di (02-03) / GTX 4-Tec (02-06) / RXT (05-06) / GTX Ltd / GTX Wake (06-08) / Wake Pro 215 (09)	SEW88-B



Royal Blue/Silver CF*

Sea-Doo	Part No.
GTX (07-09)	SEW881-B
GTX Limited (08) Non IS	



Black Vinyl/Black CF*/Yellow Vinyl

Sea-Doo	Part No.
RXT iS (09-12)	SEW882-B
RXT 260 & RXT-X 260 (10-15)	
Wake Pro 215 (10-15) / RXT-X aS 260 (12-15)	



Black/Black CF*

Sea-Doo	Part No.
GTX Limited iS (09-15)	SEW883-A
GTX 155/215 (10-15)	
GTX Ltd iS (09-15) / GTX 155	
GTX 215 (10-15)	



Black/Black CF*/Silver CF*

Sea-Doo	Part No.
GTS 130 / GTI 130 (11-16) / Wake 155 (12-16)	SEW884-B



Black/Silver CF*

Sea-Doo	Part No.
GTR 215	SEW885-B
GTI SE 130 / GTI SE 155	
GTI Ltd 155 (12-16)	



Black/Silver CF*

Sea-Doo	Part No.
RXP / 215 (04-08)	SEW89-B



Silver CF*/Black

Sea-Doo	Part No.
RXP-X (04-11)	SEW891-B



Black/Silver CF*

Sea-Doo	Part No.
RXP-X 260 (12-15)	SEW892-B
RXP-X 300 (16)	

*CF indicates Carbon Fiber-look material

FOUR STROKE
INTAKE SYSTEMS
ENGINE/GASKETS
EXHAUST
DRIVE LINE HANDLING
ELECTRICAL
WATERLINE /BILGE
STEERING & CONTROLS
BODY
ACCESSORIES
SERVICE TOOLS /HARDWARE
CHEMICAL

HYDRO-TURF CHIN PAD COVERS

See page 273 for Hydro-Turf chin pad cover color option information.



Kawasaki Part No.
Superjet (90-95) **SEW75P-A**



Yamaha Part No.
Superjet (96-16) / FX1 **SEW751P-A**



Kawasaki Part No.
750SX **SEW67P-A**



Kawasaki Part No.
800SX-R **SEW68P-A**



Kawasaki Part No.
JS300/440/550 **SEW20P-A**



Kawasaki Part No.
JS650SX **SEW65P-A**



HYDRO-TURF PREMIER CUSTOM ORDER CHIN PAD COVERS AND SEAT COVERS

HT PREMIER CHIN PAD COVERS



Kawasaki Part No.
800 SXR **AZ-SEW68P-B**
750 SX/SXI



Yamaha Part No.
Superjet (96-16) / FX1 **AZ-SEW751P-B**



A.



C.

HYDRO-TURF HANDLE POLE SHOCK PADS

Protects engine hood from damage when handlepole is dropped.
Color: Black only



B.

Description	Part No.
A. Kawasaki 750SX/SXI/800SXR (1)	TS401
B. Kawasaki JS300/440/550 (2)	TS411
C. Yamaha Super Jet (1)	TS421



TS43



TS44

SIDE LIFTER WEDGE

For a quick and semi-permanent advantage. Great when used for racers & beginner freestylers. Provides the "wedge" you need. Color: Black only

Description	Part No.
2" x 13" Black x 2 pieces	TS43
2.5" x 24" Black x 2 pieces	TS44



KICK02

KICK01

Extended



HT68K

HYDRO-TURF KICK TAIL

Add a kick tail to your watercraft 1" or 2" wedge. If installed under the traction mats, some models of watercraft may require an extended mat.

Description	Part No.
Kick Tail 5.5" x 17" x 1" Tall	KICK01
Kawasaki 800 SX-R Mat with 1" Kick Tail	HT68K-BLK
Kick Tail 5.5" x 17" x 2" Tall	KICK02

HT PREMIER CHIN PAD COVERS



Kawasaki Part No.
800 SXR **AZ-SEW68P-B**
750 SX/SXI



Yamaha Part No.
Superjet (96-16) / FX1 **AZ-SEW751P-B**



1. Ultra 250/260/300
AZ-SEW62-B

KAWASAKI	Part No.
1. Ultra 250 / Ultra LX (07-08), 260X (09-13), 300X (11-14), 310X (14-16)	AZ-SEW62
1200 STX-R (02-05), STX (03-05), 900 STX (06), STX (12-13)	AZ-SEW64R
STX-12F (06-11), STX-15F (06-16)	AZ-SEW641
Ultra 260 LX (10-12) / Ultra LX, 250 LX, 300 & 310 LX (11-16)	AZ-SEW62C
310 R & 310X SE (14-16)	AZ-SEW621



Wave Blaster
AZ-SEW74-B



Wave Blaster 2
AZ-SEW741-B



XL 800/1200 LMT
AZ-SEW784-B



GP 800R/1300R
AZ-SEW792-B

YAMAHA	Part No.
Wave Blaster 1	AZ-SEW74
Wave Blaster 2	AZ-SEW741
Wave Blaster 800	AZ-SEW742
XL 1200 (98), XL 700 & 760 (98-04)	AZ-SEW782
XL 1200 Ltd (99-00), XL 800 (00-01)	AZ-SEW784
GP/GP 1200R (99 & Pre 99)	AZ-SEW79
GP 800R (01-02), 1200R (00-02)	AZ-SEW791
GP 800R (03-04), 1300R (03-08)	AZ-SEW792

HYDRO-TURF PREMIER CUSTOM ORDER SEAT COVERS



FX Cruiser HO & FX Cruiser SHO (12-13)
AZ-SEWFX21-B



FZS (09-16)
AZ-SEWFZS-B



FX SHO (08-11)
AZ-SEWFX1-B



FX SHO & FX HO (12-15)
AZ-SEWFX11-B



FZR (12-16)
AZ-SEWFZR1-B



FZR (09-11)
AZ-SEWFZR-B



VXR (15-16)
AZ-SEWVXR1-B



VXS/VX Deluxe/VX Sport (11-14) V1/V1 Sport (15-16)
AZ-SEWVX1-B

YAMAHA

	Part No.
FX SHO (2008-11)	AZ-SEWFX1
FX SHO & FX HO (12-15)	AZ-SEWFX11
FX Cruiser HO & FX Cruiser SHO (12-13)	AZ-SEWFX21
FX Cruiser HO & FX Cruiser SHO (14-16)	AZ-SEWFX22
FX Cruiser SVHO (14-16)	
FZR (09-11)	AZ-SEWFZR
FZR (12-16)	AZ-SEWFZR1
FZS (09-16)	AZ-SEWFZS
VX (05-09) / VXS, DLX & SPT (10)	AZ-SEWVX
VXS/VX Deluxe/VX Sport (11-14)/V1/V1 Sport (15-16)	AZ-SEWVX1
VX, VXS, VX Deluxe (15-16)	AZ-SEWVX2
VX Cruiser (10-14)	AZ-SEWVXC1
VX Cruiser (15-16) / VX Cruiser HO / VX Limited (16)	AZ-SEWVXC2
VXR (11-14)	AZ-SEWVXR
VXR (15-16)	AZ-SEWVXR1

FOUR STROKE
INTAKE SYSTEMS
ENGINE/GASKETS
EXHAUST
DRIVE LINE HANDLING
ELECTRICAL
WATERLINE /BILGE
STEERING & CONTROLS
BODY
ACCESSORIES
SERVICE TOOLS /HARDWARE
CHEMICAL



SPARK 2-SEATER
AZ-SEW81-B



SPARK 3-SEATER
AZ-SEW811-B



GTI 4-Tec (06-08) / GTI 130 (10)
AZ-SEW824-B



XPL (97-04)
AZ-SEW84-B



RXT-X
AZ-SEW88-B



GTX (07-09)
AZ-SEW881-B



RXT-X 260
AZ-SEW882-B



GTS 130
AZ-SEW884-B



GTR 215
AZ-SEW885-A



RXP 215
AZ-SEW89-B

SEA-DOO

	Part No.
Spark (14-16) 2-Seater	AZ-SEW81
Spark (14-16) 3-Seater	AZ-SEW811
GTI 4-Tec (06-08) / GTI 130 (10)	AZ-SEW824
XP (93-96), SP Family (94-99)	AZ-SEW83
GX, GSX	AZ-SEW831
XP (XPL) (97-04)	AZ-SEW84
RX / RXX	AZ-SEW86
GTX Di (02-03) / GTX 4-Tec (02-06) / RXT (05-06)	AZ-SEW88
GTX Ltd / GTX Wake (06-08) / Wake Pro 215 (09)	
GTX (07-09), GTX Limited (08) (Non iS)	AZ-SEW881
RXT-iS (09-12) / RXT 260 / RXT-X 260	AZ-SEW882
Wake Pro 215 (10-15) / RXT-X aS 260 (12-15)	
GTX Ltd iS (09-15), GTX 155/ GTX 215 (10-15), GTX 130 / GTI 130 (11-16) / Wake 155 (12-16)	AZ-SEW883
GTR 215 / GTI SE130 / GTI SE155 / GTI Ltd 155 (12-16)	AZ-SEW885
RXT-X 300, RXT-X aS 260, RXT 260, Wake Pro 215 (16)	AZ-SEW886
GTX Ltd 215, GTX Ltd 300, GTX Ltd iS 260, GTX 155, GTX S 155 (16)	AZ-SEW887
RXP 215 (04-08)	AZ-SEW89
RXP-X (04-11)	AZ-SEW891
RXP-X 260 (12-15), RXP-X 300 (16)	AZ-SEW892



RXP-X (04-11)
AZ-SEW891-B



RXP-X 260 (12-15) RXP-X300 (16)
AZ-SEW892-B

HOW TO ORDER HYDRO-TURF MAT KITS

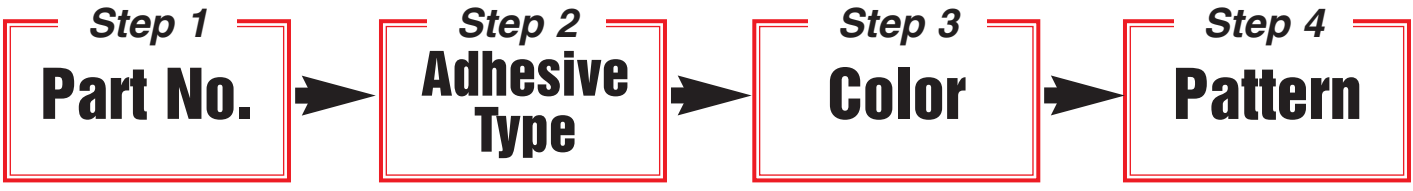

GLUE DOWN EXAMPLE: HT70-ONG-CD

PSA EXAMPLE: HT70-PSA-ONG-CD

Step 1 - Find Model and Part No.

HYDRO-TURF MATS

Hydro-Turf® is a leading manufacturer of performance traction mats and seat covers. Hydro-turf offers some of the best looking, best gripping ride mats on the market. Superior traction grooves and excellent durability are the choice for amateur and professional riders looking to upgrade or replace their existing traction mats.

**All mat kits listed on page 278 of the 2016 Hot Products Catalog that are Glue Down Black Cut Groove qualify for the Hot Products Quantity Discount Program. All other colors, patterns and PSA Adhesive kits do not qualify for any discounts.*



Yamaha	Part No.	Stocked Color	PSA Available
Wave Runner	HT70	BLK	YES
FX1	HT71	BLK	YES
SUV	HT72	BLK	YES
Wave Runner III	HT73	BLK	YES
Wave Blaster	HT74	BLK	YES
Wave Blaster II	HT741	BLK	YES
Wave Blaster 800	HT742	BLK	YES
Super Jet (90-95)	HT75	BLK	NO
Super Jet (96-16)	HT751	BLK	NO
Wave Raider	HT76	BLK	YES
VXR, VXR-Pro (pre 2010)	HT77	BLK	YES
Wave Venture/XL1200(98)/XL700 & 760 (98-04)	HT78	BLK	YES
XL1200 LTD (99-04), XL800/XLT1200/XLT800	HT784	BLK	YES
GP/GP1200R (99)	HT79	BLK	YES
GP1300R/GP1200R(00-02), GP800R (01-05)	HT791	BLK	YES
FX, FX HO (02-09)	HTFX	BLK	YES
FX SHO (08-11), FZR & FZS (09-16), FX HO (10-11)	HTFX1	BLK	YES
FX SHO & Cruiser (12-15), FX HO & Cruiser SVHO (12-16)	HTFX2	BLK	YES
VX (05-09)	HTVX	BLK	YES
VXS/VXR/VX SPT/VX CR/VX DLX (10-14), V1/V1 Sport (15-16)	HTVX1	BLK	YES
VXS/VXR/VX SPT/VX CR/VX DLX/VX (15-16)	HTVX2	BLK	YES

Hydrospace	Part No.	Stocked Color	PSA Available
Hydrospace S4 with 2" Kick Tail	HT100	BLK	YES

Polaris	Part No.	Stocked Color	PSA Available
SL/SLX (-99), 785Pro (99-01)	HT90	BLK	YES
Hurricane	HT91	BLK	YES
SLXH(98), SLH & SLX(99)	HT92	BLK	YES
SLH/SLX/Pro 1200 (00-01)	HT921	BLK	YES
SLT, SLTX, X-45	HT93	BLK	YES
Virage, Freedom	HT94	BLK	YES
Genesis	HT95	BLK	YES
Octane (Rail cap mat pieces not included)	HT96	BLK	YES
MSX	HT97	BLK	YES

Sea-Doo	Part No.	Stocked Color	PSA Available
XP (Pre 93), SP Family (Pre 94)	HT80	BLK	YES
Spark (2 Seat Model) (14-16)	HT81-PSA	BLK	PSA Only
Spark (3 Seat Model) (14-16)	HT811-PSA	BLK	PSA Only
GT Family (90-95), GTI (96), GTS (96-00)	HT82	BLK	YES
GTX (96-02), GTI (97-00)	HT821	BLK	YES
GTS (01), GTI (01-05)	HT823	BLK	YES
GTI 4-Tec (06-08)	HT824	BLK	YES
XP (93-96), SP Family (94-99)	HT83	BLK	YES
GS Family	HT831	BLK	YES
XP (97-04)	HT84	BLK	YES
LRV	HT85	BLK	YES
RX / RXX	HT86	BLK	YES
HX	HT87	BLK	YES
GTX DI (02) & GTX 4-TEC (02-05), GTX (03-08), RXT & RXT-X (Pre 2009)	HT88	BLK	YES
RXT iS, iS 260 & aS 260 (09-16)	HT882-PSA	BLK	PSA Only
GTX S 155 (12-16), GTX Ltd iS (09-16)			

<i>*All HT882 are supplied with 300 LSE PSA 3M adhesive pre applied for a Peel & Stick installation.</i>			
GTI 130, GTI SE 130 (11-16) /	HT884	BLK	YES
GTI Ltd 155, GTI SE 155 / GTS 130 / Wake 155 / GTR 215 (12-16)			
RXT-X 260 & RXT 260 (12-16),	HT885-PSA	BLK	PSA Only
RXT-X (10-11), Wake Pro 215 (12-16), GTX 155/215 (12-16)			
<i>*All HT885 are supplied with 300 LSE PSA 3M adhesive pre applied for a Peel & Stick installation.</i>			
RXP (Pre 06)	HT89	BLK	YES
RXP-X (06-11), RXP-X (08-11)	HT891	BLK	YES
3D	HT3D	BLK	YES
RXP-X 260 (12+)	HT892	BLK	YES

Kawasaki	Part No.	Stocked Color	PSA Available
JS300/440/550	HT20	BLK	YES
JF650X2	HT40	BLK	YES
X2 European Model	HT41	BLK	YES
JS550SX	HT55	BLK	YES
ZXI	HT60	BLK	YES
Ultra 150, Ultra 130	HT61	BLK	YES
Ultra 250 / LX (07-08) / 260X (09-13) / 300X (11-14) / 310X (14-16)	HT62	BLK	YES
ST/STS/750STX&900STX (pre 99)	HT63	BLK	YES
STX1100 (97-99)	HT631	BLK	YES
STX900 (99-00), 900STS (01-02)			
STX1100DI (00-02), All STX (01-16), 12F, 15F, STXR	HT64	BLK	YES
JS650SX	HT65	BLK	YES
750SS/XI/XIR	HT66	BLK	YES
JS750SX/SXI	HT67	BLK	YES
800 SX-R	HT68	BLK	YES
800 SX-R with Kick Tail (1")	HT68K	BLK	YES

Honda	Part No.	Stocked Color	PSA Available
F-12/F-12X	HT05	BLK	YES
R-12/R-12X	HT06	BLK	YES
F-15X	HT07	BLK	YES

All Hydro-Turf Mat Kits (except SuperJet mat kits) are now available with "PSA" (3M 486 MP Pressure Sensitive Adhesive). PSA Mat Kits are special order only and additional fees will apply.

All Mat Kits with black cut groove qualify for Hot Products' Quantity Discount. All other colors and patterns are not qualified for the discount.

Step 2 - Select Glue Down or "PSA" Pressure Sensitive Adhesive

Glue Down Type

Glue Down comes standard and no code is necessary.



All Hydro-Turf mat kits now have the Hydro-Turf oval logo.

PSA Type

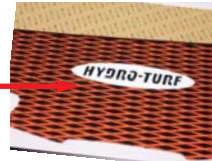

PSA type mats use 3M 486MP Pressure Sensitive Adhesive

Step 3 - Select the Hydro-Turf Color

HYDRO-TURF STANDARD COLORS



Color: Black
Code: BLK



Color: Deep Blue
Code: DB



Color: Royal Blue
Code: ROY



Color: Light Gray
Code: LGY



Color: Dark Gray
Code: DGY



Color: Pink
Code: PK



Color: Purple
Code: PUR



Color: Lime Green
Code: LGN



Color: Orange
Code: ONG



Color: Red
Code: RED

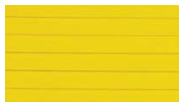

Color: Yellow
Code: YLW



Color: White
Code: WHT

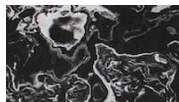

Color: Black Marble
Code: BM



Color: Royal Marble
Code: RM

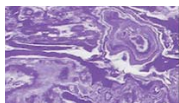

Color: Purple Marble
Code: PM



Color: Snow Camo
Code: SNCAM



Color: Blue Camo
Code: BLCAM



Color: Yellow Camo
Code: YWCAM



Color: Green Camo
Code: GNCAM



Color: Lime Green Camo
Code: LGNCAM



Color: Red Camo
Code: REDCAM



Hydro-Turf Swatches Color Rings are provided to you at NO COST. We feel they are powerful sales tools and want every dealer to have one.

Part # HT-SWATCH



HYDRO-TURF 2-TONE COLORS

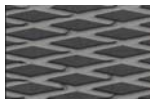

Top Color: Black
Grooves: Dark Gray
Code: 2TBLK/DGY



Top Color: Black
Grooves: Light Gray
Code: 2TBLK/LGY



Top Color: Black
Grooves: Lime Green
Code: 2TBLK/LGN



Top Color: Black
Grooves: Red
Code: 2TBLK/RED



Top Color: Black
Grooves: Royal Blue
Code: 2TBLK/ROY

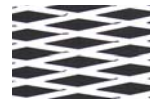

Top Color: Black
Grooves: White
Code: 2TBLK/WHT



Top Color: Black
Grooves: Pink
Code: 2TBLK/PK



Top Color: Black
Grooves: Yellow
Code: 2TBLK/YLW



Top Color: Dark Gray
Grooves: Black
Code: 2TDGY/BLK



Top Color: Light Gray
Grooves: Black
Code: 2TLGY/BLK



Top Color: Lime Green
Grooves: Black
Code: 2TLGN/BLK



Top Color: Red
Grooves: Black
Code: 2TRED/BLK

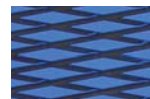

Top Color: Royal Blue
Grooves: Black
Code: 2TROY/BLK



Top Color: Black
Grooves: Orange
Code: 2TBLK/ONG



Top Color: Royal Blue
Grooves: White
Code: 2TROY/WHT



Top Color: Lime Green
Grooves: Black
Code: 2TLGN/WHT

Step 4 - Select the Pattern

PATTERNS



CUT GROOVE
Available in all colors
Code: CG



CUT DIAMOND
Available in all colors
Code: CD



MOLDED DIAMOND
Available in Black, Dark Gray, Light Gray, Royal Blue, White, Lime Green & Red • Code: MD

*Waffle Cut is not available for mat kit. It is available for sheet only. See page 280.

Hydro-Turf products are large and bulky items, and in some cases do not qualify for the Hot Products Free Shipping policy.

HotProductsUSA.com • Orders & Info: 858-453-4454

©2016 Hot Products. All rights reserved.

FOUR STRIKE
INTAKE SYSTEMS
ENGINE/GASKETS
EXHAUST
DRIVE LINE HANDLING
ELECTRICAL
WATERLINE /BILGE
STEERING & CONTROLS
BODY
ACCESSORIES
SERVICE TOOLS /HARDWARE
CHEMICAL

HOW TO ORDER HYDRO-TURF SHEETS

Step 1
Code

Step 2
Adhesive Type

Step 3
Pattern

Step 4
Color

GLUE DOWN EXAMPLE: **SHT37-WC-2TBLK/WHT**

PSA EXAMPLE: **SHT37-PSA-WC-2TBLK/WHT**

Step 1 - Select Code SHT 40 or SHT 37
SHT40 = Standard Color. Size of sheet 40" x 62"*
SHT37 = 2-Tone Color. Size of sheet 41" x 62"*

**The usable area on Hydro-Turf sheets is slightly smaller than the overall sheet size listed above, the outer edges are meant to be cut away to the usable size. See Step 3 below for each pattern's exact usable area size.*

Step 2 - Select Glue Down or Pressure Sensitive Adhesive

Glue Down Type

PSA Type

Glue Down comes standard and no code is necessary.

Step 3 - Select the Pattern



CUT GROOVE
Available in all colors
Code: CG

USABLE AREA:
Standard Color: 38" x 60"
2-Tone: 37" x 58"



CUT DIAMOND
Available in all colors
Code: CD

USABLE AREA:
Standard Color: 38" x 60"
2-Tone: 37" x 58"



MOLDED DIAMOND
Available in Black, Dark Gray, Light Gray, Royal Blue, White, Lime Green & Red
Code: MD

USABLE AREA:
37" x 58"



FLAT - NO GROOVE
Available in Standard colors
Code: F

USABLE AREA:
Standard Color: 38" x 60"



WAFFLE CUT
Available in all colors
Code: WC

USABLE AREA:
Standard Color: 40" x 50"
2-Tone: 37" x 48"

Step 4 - Select the Hydro-Turf Color

HYDRO-TURF STANDARD COLORS



Color: Black
Code: BLK



Color: Deep Blue
Code: DB



Color: Royal Blue
Code: ROY



Color: Light Gray
Code: LGY



Color: Dark Gray
Code: DGY



Color: Pink
Code: PK



Color: Purple
Code: PUR



Color: Lime Green
Code: LGN

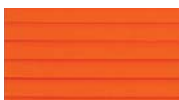

Color: Orange
Code: ONG



Color: Red
Code: RED



Color: Yellow
Code: YLW



Color: White
Code: WHT

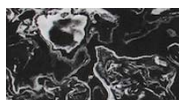

Color: Black Marble
Code: BM



Color: Royal Marble
Code: RM

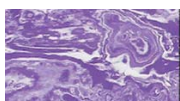

Color: Purple Marble
Code: PM



Color: Snow Camo
Code: SNCAM



Color: Blue Camo
Code: BLCAM



Color: Yellow Camo
Code: YWCAM



Color: Green Camo
Code: GNCAM



Color: Lime Green Camo
Code: LGNCAM



Color: Red Camo
Code: REDCAM

**All Hydro-Turf Standard colors sheets in Cut Groove, Cut Diamond, Waffle Cut and Molded Diamond qualify for the Hot Products Quantity Discount Program. All 2-Tone colors and PSA Adhesive sheets do not qualify for any discounts.*

HYDRO-TURF 2-TONE COLORS

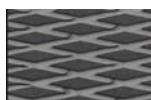

Top Color: Black
Grooves: Dark Gray
Code: 2TBLK/DGY

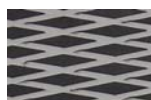

Top Color: Black
Grooves: Light Gray
Code: 2TBLK/LGY



Top Color: Black
Grooves: Lime Green
Code: 2TBLK/LGN

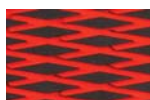

Top Color: Black
Grooves: Red
Code: 2TBLK/RED



Top Color: Black
Grooves: Royal Blue
Code: 2TBLK/ROY



Top Color: Black
Grooves: White
Code: 2TBLK/WHT



Top Color: Black
Grooves: Pink
Code: 2TBLK/PK



Top Color: Black
Grooves: Yellow
Code: 2TBLK/YLW



Top Color: Dark Gray
Grooves: Black
Code: 2TDGY/BLK



Top Color: Light Gray
Grooves: Black
Code: 2TLGY/BLK



Top Color: Lime Green
Grooves: Black
Code: 2TLGN/BLK



Top Color: Red
Grooves: Black
Code: 2TRED/BLK

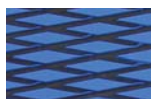

Top Color: Royal Blue
Grooves: Black
Code: 2TROY/BLK



Top Color: Black
Grooves: Orange
Code: 2TBLK/ONG



Top Color: Royal Blue
Grooves: White
Code: 2TROY/WHT



Top Color: Lime Green
Grooves: Black
Code: 2TLGN/WHT



Hydro-Turf products are large and bulky items, and in some cases do not qualify for the Hot Products Free Shipping policy.

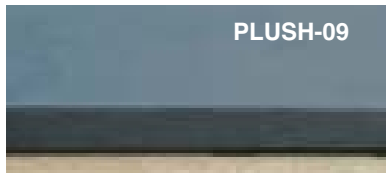

HYDRO-TURF PLUSH (BLACK)

Description	Size	Color	Part Number	Description	Size	Color	Part Number
9mm Plush	19" x 40"	Black	PLUSH-09	18mm Plush	40" x 59"	Black	PLUSH-18B
9mm Plush	17.5" x 48"	Black	PLUSH-09A	18mm Plush	48" x 88"	Black	PLUSH-18C
9mm Plush	40" x 59"	Black	PLUSH-09B	26mm Plush	19" x 40"	Black	PLUSH-26
9mm Plush	48" x 88"	Black	PLUSH-09C	26mm Plush	17.5" x 48"	Black	PLUSH-26A
18mm Plush	19" x 40"	Black	PLUSH-18	26mm Plush	40" x 59"	Black	PLUSH-26B
18mm Plush	17.5" x 48"	Black	PLUSH-18A	26mm Plush	48" x 88"	Black	PLUSH-26C

Hydro-Turf Plush underpad sheets (40" x 59" and 48" x 88") are large and oversize will incur an additional shipping fee.

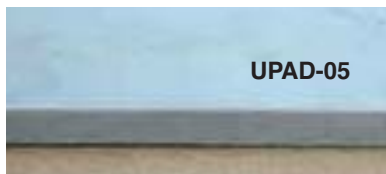

HYDRO-TURF UNDERPAD (GRAY)

Description	Size	Color	Part Number	Description	Size	Color	Part Number
Underpad 5mm	19" x 39"	Gray	UPAD-05	Underpad 8mm Large Sheet	39" x 78"	Gray	UPAD-08A
Underpad 5mm Large Sheet	39" x 78"	Gray	UPAD-05A	Underpad 25mm	19" x 39"	Gray	UPAD-25
Underpad 8mm	19" x 39"	Gray	UPAD-08				

HOW TO ORDER HYDRO-TURF JET BOAT MAT KITS



EXAMPLE: SD01-BLK-CD

HYDRO-TURF JET BOAT INTERIOR & REAR MATS

Sea-Doo	Full Mat	Rear Only	Sea-Doo (continued)	Full Mat	Rear Only
Speedster (1994-95)	SD01	SD01R	Challenger 180 (2007-11)	SD171	SD17R
Speedster (1996) / Sportster (1996-99)	SD02	SD02R	Challenger 180 (2012)	SD172	SD17R
Sportster (1994-95)	SD03	SD03R	Challenger 230/SE (2007-09)	SD18	SD18R
Challenger (1996-2000) / Speedster (1997)	SD04	SD04R	Sugar Sand	Full Mat	Rear Only
Challenger 1800 (1997-2004)	SD05	SD05R	Tango 4+2 / Super Sport (1998-06)	SS01	SS01R
Sportster 1800 (1998-2000)	SD06	SD06R	Yamaha	Full Mat	Rear Only
Speedster SK (1999)	SD07	SD07R	Exciter (all years)	Y01	Y01R
Speedster (1998-99)	SD08	SD08R	LS2000 / LX2000 (1999)	Y02A	Y02AR
Challenger 2000 (2000-04) / X (2002)	SD09	SD09R	LS2000 / LX2000 (2000+)	Y02	Y02R
Challenger X (2003-05)	SD091	SD091R	LS210 / LX210 / AR210 (-2005)	Y021	Y021R
Islandia (2000-10) Available in Flat only	SD10	SD10R	XR1800	Y03	Y03R
Utopia 185 (2001-05)	SD11	SD11R	SR230 / SX230 / AR230 (2005-06)	-	Y04R
Speedster (2000-03) / Speedster 160 (2004)	SD12	SD12R	SR 210 / SX 210 / AR 210 / 212 SS (06-11)	-	Y05R
Challenger (2001) / Sportster DI (2001-05)	SD13	SD13R	SR 230 / SX 230 / AR 230 / AR 232 (06-09)	-	Y06R
Utopia 205 (2002-05)	SD14	SD14R	242 Limited / Limited S (10-14)	-	Y07R
Utopia 205 SE (2007)	-	SD14R	AR 240 HO / SX 240 HO (10-14)	-	Y071R
Utopia 205 SE (2008)	-	SD141R	AR 240 HO / SX 240 HO (15-16)	-	Y072R
Sportster 4-Tec (2003-05) / SCIC (2005-06)	SD15	SD15R	242 Limited & 242 Limited S (15-16)	-	Y073R
Speedster 150 (2007-12)			212 X / 212 SS / AR 210 / SX 210 (12-16)	-	Y08R
Speedster 200 (2004-12) / Wake (2006-09)	SD16	SD16R	AR 190 / SX 190 (12-16) / AR 192 / SX 192 (13-16)	-	Y09R
Challenger 180 (2005-06)	SD17	SD17R			

All Jet Boat mats now come with 3M self-adhesive.

FOUR
STROKE
INTAKE
SYSTEMS
ENGINE/
GASKETS
EXHAUST
DRIVE LINE
HANDLING
ELECTRICAL
WATERLINE
/BILGE
STEERING
& CONTROLS
BODY
ACCESSORIES
SERVICE TOOLS
/HARDWARE
CHEMICAL

HYDRO-TURF SPECIAL MATS FOR KAWASAKI 750 & 800



HYDRO-TURF SPECIAL MATS FOR YAMAHA SUPER JET

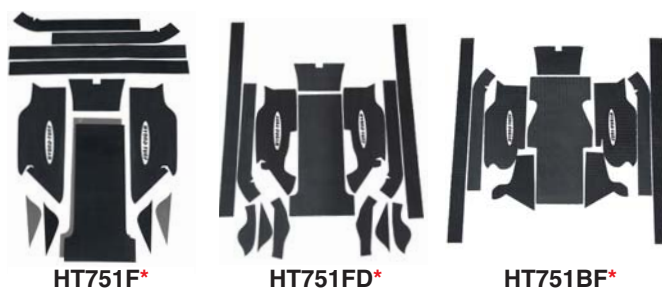

*Cut Groove kits are supplied with smooth side wall pieces.
Cut Diamond and Molded Diamond kits are supplied with the matching pattern on the side wall pieces.*

Kawasaki	Part No.	Yamaha	Part No.
750SX/750SXI Mats for use with "Digger" Footholds	HT67F*	Super Jet (96-16) Mats for use with Wamilton Footholds	HT751F*
750SX/750SXI Freestyle Mat Kit "No Cutouts"	HT67FS*	Super Jet (96-16) Mats for use with Blowsion "Digger" Footholds	HT751FD*
800 SXR Mats for use with "Kicker" Footholds and Blowsion Rail Caps	HT68BF*	Super Jet (96-16) Mats for use with Blowsion "Kicker" Footholds	HT751BF*
800 SXR Mats for use with "Klowners" Footwells and Blowsion Rail Caps	04-02-023*	Super Jet (96-16) Mats for use with Blowsion "Klowners" Footwells	04-02-077*
800 SXR Mats with 1" kick tail for use with Blowsion Rail Caps	HT68RC*	Bumper Rail Strips/Mats for (all stand up models)	TS50-BLK
Blowsion Composite Rail Caps	KASRUP402		

**These mats are not available with "PSA" 3M adhesive.*

**All mat kits listed on page 262 of the 2014 Hot Products Catalog that are Glue Down Black Cut Groove qualify for the Hot Products Quantity Discount Program. All other colors and patterns kits do not qualify for any discounts.*



BLOWSION DIGGER FOOTWELLS

Considered a must have modification for any surf or freerider. The Digger features a recessed "notch" at the back of each footwell to allow rider to wedge foot during tail stands & surf recoveries.
For **HT67F** & **HT751FD**.

Description	Part No.
Dawson Diggers	05-03-004
Superjet (96-16) Mats for use with Blowsion "Digger" Footholds	HT751FD
750SXI Mats for use with Blowsion "Digger" Footholds	HT67F



BLOWSION LUSTIC KICKER FOOTWELLS

Designed especially for all years Super Jet and the 800 SXR, these beauties have been used exclusively by Josh Lusic on his Blowsion prepared Factory Pro Kawi SXR 800. These custom molded fiberglass insets provide the room in the tray of your ski for lock down aerials.
For **HT68BT** & **HT751BF**.

Description	Part No.
Lusic Footwell	05-03-005
800 SXR Mats for use with "Kicker" Footholds & Blowsion Rail Caps	HT68BF
Superjet (96-16) Mats for use with Blowsion "Kicker" Footholds	HT751BF



BLOWSION FOOTWELLS KLOWNERS

Designed especially for the rider who needs MAX room in the tray. These hand-laid, molded fiberglass insets provide extended room in the tray of your ski to position your feet. Comfortably sized for large to very large feet, the Klowner footwells contour to your ankle and also feature a gentle protrusion over the top of your foot for better locking power. Built with safety and performance in mind, the Klowner footwells will keep you in your ski while inverted, and also easily let you go when you feel like you're going to need a hurried dismount to avoid facial impact on fiberglass.

Description	Part No.
Klowners Footwell	05-03-007
Super Jet (96-16) Mats for use with Blowsion "Klowners" Footwells	04-02-077
800 SXR Mats for use with "Klowners" Footwells & Blowsion Rail Caps	04-02-023



WAMILTON "RICKTER" FOOTWELLS

A must have for surf riding. These Wamilton fiberglass footwells work with Hydro Turf SuperJet freestyle mats. For **HT751F**.

Description	Part No.
Superjet Rickter Footwells	FHWAM
Superjet (96-16) Mats for use with Wamilton "Rickter" Footwells	HT751F



SX-R RAIL CAPS

Newly re-tooled and now an even better fit! The composite crew at Blowsion has made new mold sets off of Blowsion's SXR Carbon Hull making these new generation SXR Rail Caps a PERFECT fit! A complex fitting piece now made with the best fit and features available. Get rid of those extremely slippery factory rubber black rails and go composite.

Description	Part No.
Blowsion SX-R Rail Cap	05-04-001
800 SXR Mats for use with "Kicker" Footholds & Blowsion Rail Caps	HT68BF
800 SXR Mats with 1" kick tail for use with Blowsion Rail Caps	HT68RC



HOT PRODUCTS YAMAHA ALUMINUM NOSE BUSHING

Yamaha	Part No.
Silver	57-6310
Black	57-6312
Blue	57-6314
Red	57-6316



HOT PRODUCTS KAWASAKI (89+) ALUMINUM NOSE BUSHING

Kawasaki	Part No.
Silver	57-6270
Black	57-6272
Blue	57-6274
Red	57-6276



BLOWSION EXTENDED ALUMINUM NOSE BUSHING

Description	Part No.
Clear	04-03-058
Black	04-03-051



BILLET BOW EYE

Description	Part No.
Black	TI-BOW-EYE-BIL-BLK
Silver	TI-BOW-EYE-BIL-SIL
Red	TI-BOW-EYE-BIL-RED
Blue	TI-BOW-EYE-BIL-BLU
Orange	TI-BOW-EYE-BIL-ORG
Green	TI-BOW-EYE-BIL-GRN



RICK ROY PRODUCTS FOOT HOLD INSERT

Description	Part No.
Rick Roy Rickter Foot Hold Insert	RICKTER-FT-HOLD



HOT PRODUCTS 1" EXTENDED LENGTH YAMAHA NOSE BUSHING

Yamaha	Part No.
Silver	57-6510
Black	57-6512
Blue	57-6514
Red	57-6516



AWD PRODUCTS QUICK LOOP

A flexible tow loop is required for all watercraft of IJSBA Race. Specially designed to meet IJSBA regulations. The New "Yellow" loop is for all dark bottom hulls, the "Yellow" loop will make it easier for the water safety team to see the loop and hook on to a race ski faster.

Description	Color	Part No.
"Tow Hook"	Black	QL01-B
"Tow Hook"	Yellow	QL01-Y
"Bow Eye"	Black	QL-02



Yamaha
57-6285



Kawasaki
57-6275

HOT PRODUCTS STAINLESS STEEL NOSE BUSHINGS

These stainless Steel nose bushings have been developed to prevent corrosion from salt water and the extra strength and durability will allow the bushings to last years longer than the aluminum bushings. Even the nose bushing nut is stainless steel.

Description	Part No.
Yamaha All	57-6285
Kawasaki 89+	57-6275



FOUR
STROKE
INTAKE
SYSTEMS
ENGINE/
GASKETS
EXHAUST
DRIVE LINE
HANDLING
ELECTRICAL
WATERLINE
/BILGE
STEERING
& CONTROLS
BODY
ACCESSORIES
SERVICE TOOLS
/HARDWARE
CHEMICAL



FRONT HOOD HOOKS

Description	Part No.
A. SX-R Hood Hooks, Black	04-04-101
B. Superjet Hood Hooks, Black	04-04-105



ADJUSTABLE HOOD LATCH FOR YAMAHA & KAWASAKI

Description	Part No.
Black	TI-HL-BIL-ADJ-BLK
Red	TI-HL-BIL-ADJ-RED
Blue	TI-HL-BIL-ADJ-BLU
Orange	TI-HL-BIL-ADJ-ORG
Green	TI-HL-BIL-ADJ-GRN

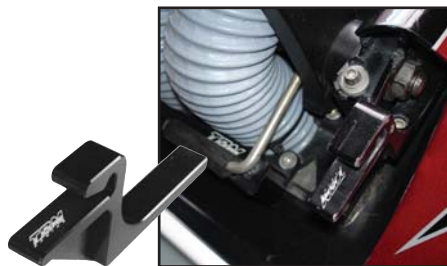

SX-R BILLET HOOD HOOKS

A direct replacement for the weak OEM SX-R 800 hood latches that bend and commonly fail, these hood latches are manufactured from 6061 billet aluminum. TBM eliminated all stress risers to ensure latches will stand up to the most extreme riding conditions eliminating the chance of a failure that can lead to the hood coming loose.

Description	Part No.
Billet Hood Hooks, Black	TBM109



BILLET HOOD LATCH

Recently updated and re-machined to also fit the Kawasaki SXR800, SXI Pro all Yamaha Superjet and FX1.

Description	Part No.
Hood Latch Black	04-04-001
Hood Latch Green	04-04-004
Hood Latch Red	04-04-007
Hood Latch Clear	04-04-008



ADA RACING HOOD HOOKS FOR YAMAHA SUPERJET

Billet hood hooks for the Yamaha Super Jet designed by freestyle guru Jeremy Parr. Instead of the hood sliding forward into the hooks, these face forward so the hood comes back into them holding the hood from coming backward.

Description	Color	Part No.
Hood Hook	Silver	34-660190
Hood Hook	Black	34-660100
Hood Hook	Blue	34-660110
Hood Hook	Red	34-660120



BLOWSION STAINLESS HOOD LATCH ASSEMBLY

Fits all 650/750/800/X2 Kawasaki. May also be used to retro-fit all years Yamaha Superjet and FX1. Comes complete with latch assembly and hood clip. 100% polished stainless. Trick and functional. Why incur the factory OEM replacement expense?

Description	Part No.
Blowsion Stainless Hood Latch	04-04-030



04-02-335



04-02-336



04-02-337



04-02-339

DAKINE FOOT STRAPS

*Strap is sold separately

Description	Part No.
Dakine Supremo Footstrap	04-02-335
Dakine Proforma Footstrap	04-02-336
Dakine X-Lace Footstrap	04-02-337
Dakine Hrdwr kit - less glue	04-02-338
Dakine Hrdwr kit - with glue	04-02-339



BRAP STRAP

Strap and secure your hood to avoid accidental dislodging during freestyle

and freeride maneuvers. Replaces stock latch assembly. All mounting hardware included. A must for extreme ocean and big wave riders. "Cinchable" strap tension means you pre-load strap holding power. Fits all SJ, SXR800, FX1,750sxi and Octane. EJ-Pam 2008 approved!

Description	Part No.
Blowsion Brap Strap	04-04-310



HOOD STRAP KIT

Secure your stand-up's hood to avoid accidental dislodging during freestyle and freeride maneuvers. All stainless mounting hardware and instructions included.

Description	Part No.
Blowsion Hood Strap Kit	04-04-301



HYDRO-TURF UNIVERSAL HOOD SEAL

Hydro-Turf developed this quality hood seal utilizing their new plush foam. 3/4" wide x 1" tall x 100" long Works great on:
Kawasaki JS300, JS440, JS550 & 550SX
Yamaha SJ650 & SJ700 (1994-95)

Description	Part. No.
Hydro-Turf Universal Hood Seal	TS56



WATCON HOOD SEAL

Replace your hood seal with our updated version. The self adhesive seal is much thicker and wider, which keeps the hood intact during the wide-open surf rides and big wave action. We supply approx. 110" of material. Fits: 1994-2016 SuperJet, 2002-04 Polaris Octane, 1993-96 Yamaha Wave Blaster and aftermarket hulls.

Description	Part. No.
Superjet Octane Hood Seal	OCT-HS



A.



B.

Description	Part. No.
A. Super Jet 96+ Mid mount drop-in hand holds for stock hoods.	05-04-271
B. Universal mount drop-in hand holds are easily located on any flat surface.	05-04-203



HOOD Baffle INSERT FOR FACTORY PIPE 800 SX-R

Use this composite drop in baffle insert to cover the area removed during installation of the factory pipe dry pipe for Kawasaki 800SXR.

Description	Part. No.
Hood Insert 800 SX-R	05-02-108



EXTREME THROTTLE YAMAHA WAVE BLASTER HOOD SEAL

Description	Part. No.
Wave Blaster Hood Seal	EXB1SEAL



UFO MOUNTING DISK & HULL HOOK

C. With this tough stainless steel disk you can mount battery boxes, clips to secure straps to mount gas tanks, exhaust system components, and many other parts with ease in custom hulls. Installation is easy simply scuff both mounting surfaces, epoxy and let cure.

Each disk is sold separately and includes mounting socket. Note OEM clips shown are sold separately.

D. Thrust innovation hull hooks are made from billet aluminum and anodized black for light weight and a clean finished look. They will work with Yamaha hull straps and you can either glue or glass in place anywhere on your hull

Description	Part. No.
C. UFO Mounting Disk	TI-MTN-DSK
D. Hull Hook	TI-HL-HK-BLK



011-800



011-805



011-810

STORAGE COMPARTMENT & SEAT LATCH ASSEMBLY

Sea-Doo	Part. No.
Seat Latch Assembly (OEM # 269-00-016)	011-800
Front Compartment Latch RX, RXDI, GTI LE, GTI XP 03-04 (OEM # 269-501-125)	011-805

Yamaha	Part. No.
Seat Latch Assembly (OEM # FOD-63850-01-00)	011-810

FOUR STROKE
INTAKE SYSTEMS
ENGINE/GASKETS
EXHAUST
DRIVE LINE HANDLING
ELECTRICAL
WATERLINE /BILGE
STEERING & CONTROLS
BODY
ACCESSORIES
SERVICE TOOLS /HARDWARE
CHEMICAL

FOUR STROKE
INTAKE SYSTEMS
ENGINE/GASKETS
EXHAUST
DRIVE LINE HANDLING
ELECTRICAL
WATERLINE /BILGE
STEERING & CONTROLS
BODY
SERVICE TOOLS ACCESSORIES
/HARDWARE
CHEMICAL



BLOWSION LOW PROFILE BILLET YAMAHA FUEL CAPS



BLOWSION BILLET KAWASAKI FUEL CAPS

Yamaha	Part No.
Low Profile Black	04-03-151
Low Profile Blue	04-03-152
Low Profile Green	04-03-154
Low Profile Orange	04-03-155
Low Profile Red	04-03-157
Low Profile Clear	04-03-158

Kawasaki	Part No.
Black	04-03-101
Blue	04-03-102
Green	04-03-104
Orange	04-03-105
Red	04-03-107
Clear	04-03-108

BlowSION fuel caps do not include a fuel cap seal. Seal sold separately.

BlowSION fuel caps do not include a fuel cap seal. Seal sold separately.



HOT PRODUCTS RACING BILLET YAMAHA GAS CAP

Yamaha	Part No.
Silver	50-9511
Black	50-9512
Blue	50-9513
Red	50-9514

Hot Products gas caps include a gas cap seal.



New for 2016

The new Hot Products gas cap for Kawasaki PWCs, this new cap is available in 5 colors of anodizing and then feature a final CNC machining process to create the silver aluminum highlights.

The image supplied is of the prototype gas cap and the final gas cap might vary during the final product.

HOT PRODUCTS RACING BILLET KAWASAKI GAS CAP

Kawasaki	Part No.
Silver	50-9521
Black	50-9522
Blue	50-9523
Red	50-9524
Green	50-9525

Hot Products gas caps include a gas cap seal.

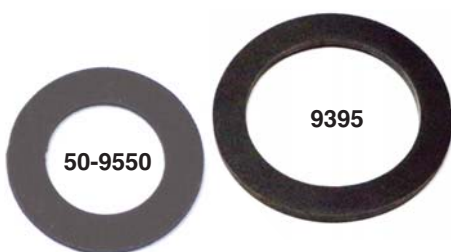

HOT PRODUCTS GAS CAP GASKETS

Made of Viton for better sealing and to prevent damage from ethanol or race fuels.

Description	Part No.
Gas Cap Gasket for Kawasaki OEM #11009-3020	50-9550
Gas Cap Gasket for Yamaha	9395



TBM RACING BILLET YAMAHA GAS CAP

Yamaha	Part No.
Black	TBM105-Y-BLK
Blue	TBM105-Y-BLU

TBM Racing gas caps do not include a gas cap seal. Seal sold separately.

TBM RACING BILLET KAWASAKI GAS CAP

Kawasaki	Part No.
Black	TBM105-B
Green	TBM105-G
Red	TBM105-R

TBM Racing gas caps do not include a gas cap seal. Seal sold separately.



ADA RACING BILLET FUEL CAP SOCKET

Billet aluminum fuel cap socket for the Yamaha Super Jet, WaveBlaster, & Wave Raider or Kawasaki 800 SX-R, 12/15F, STX-R, 1100ZXI & 900 STX. Works with the stock plastic or aftermarket billet gas caps. Includes attached chain.



Description	Color	Part No.
Yamaha Fuel Socket	Black	34-450100
Yamaha Fuel Socket	Silver	34-450190
Kawasaki Fuel Socket	Black	31-450100
Kawasaki Fuel Socket	Silver	31-450190

Hot Products recommends you purchase a ADA Racing Fuel Cap to insure the threads are a match and the fuel cap will properly seal.



TBM RACING BILLET FUEL FILLER NECK

Description	Part No.
A. Yamaha Fuel Filler Neck	TBM105-YFN
B. Kawasaki Fuel Filler Neck	TBM105-KFN

Hot Products recommends you purchase a TBM Racing Fuel Cap to insure the threads are a match and the fuel cap will properly seal.



TBM RACING BILLET SX-R EXHAUST FLANGE

Kawasaki	Part No.
SX-R 800 Billet Exhaust Flange Black	TBM110
SX-R 800 Billet Exhaust Flange Silver	TBM110-P



RIVA BILLET CHOKE KNOB FOR YAMAHA

Yamaha	Part No.
RIVA Racing Billet Choke Knob Silver	RY843P



BILLET EXHAUST NOZZLE FOR YAMAHA SJ96+

Yamaha SJ96+	Part No.	Yamaha SJ96+	Part No.
Black	04-03-251	Orange	04-03-255
Blue	04-03-252	Red	04-03-257
Green	04-03-254	Clear	04-03-258



BLOWSION BILLET EXHAUST NOZZLE FOR 800 SXR

Kawasaki 800 SXR	Part No.
Black	04-03-201
Blue	04-03-202
Green	04-03-204
Orange	04-03-205
Red	04-03-207
Clear	04-03-208



SE-098062 SE-098066 SE-098069 SE-098070S

SE "SPEED MAGIC"

ULTRA 250/260/300/310 EXHAUST FLANGE

Description	Part No.
Trumpet Flange - Silver	SE-098062
Cyclone Flange - Silver	SE-098066
Megaton 4 Flange - Silver	SE-098069
Type 5 Flange - Silver	SE-098070S

FOUR STROKE
INTAKE SYSTEMS
ENGINE/GASKETS
EXHAUST
DRIVE LINE HANDLING
ELECTRICAL
WATERLINE /BILGE
STEERING & CONTROLS
BODY
ACCESSORIES
SERVICE TOOLS /HARDWARE
CHEMICAL

FOUR
STROKEINTAKE
SYSTEMSENGINE/
GASKETS

EXHAUST

DRIVE LINE
HANDLING

ELECTRICAL

WATERLINE
/BILGESTEERING
& CONTROLS

BODY

ACCESSORIES

SERVICE TOOLS
/HARDWARE

CHEMICAL



HYDRO-TURF SPLASH GUARDS

Description	Part No.
Hydro-Turf Splash Guard (5.5" x 40") Rivets Included	TS01



JETTRIM SPLASH GUARDS

Description	Part No.
Small • 52" Length For two seat PWC	57-7029
Large • 60" Length For three seat PWC	57-7030
Large • 58" Length <i>FLAME DESIGN</i> For three seat PWC	57-7032



57-7032
Flame Design



HYDRO-TURF MOLDED SPLASH GUARDS

Description	Part No.
Hydro-Turf Splash Guard 60" (Molded)	TS03



TBM RACE BUMPERS

Introducing the easiest way to enhance the handling of your SX-R simply by replacing your stock bumper with our adhesive backed bumpers. These eliminate the need for rivets and narrows the bond flange increasing the lean angle of your ski. They also enhance the general appearance significantly.

Description	Part No.
800SXR (2 pieces, 8' each)	TBM117
STXR, 12F, 15F, ULTRA 250X/LX (1 pieces, 25' each)	TBM117-STXR/ULTRA
Hydrospace (1 piece, 193" & 1 piece 22")	TBM117-HS
Zapata FZ950	TBM117-F8950

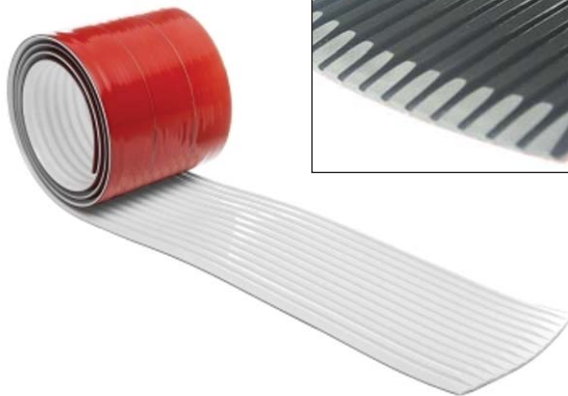

KEEL PROTECTION FOR YOUR PWC

- Easy, do-it-yourself installation
- Uses 3m Adhesive System
- Prevents costly repairs
- Maintains the value of your PWC
- 100% made in the U.S.A.

Length	Color	Part No.
4'	White	KS-4-W
5'	White	KS-5-W
6'	White	KS-6-W



OVERALL STAND-UP CHAMPION OF THE 2015 HOT PRODUCTS
IJSBA MARK HAHN MEMORIAL HAVASU 300 ENDURANCE RACE
BIBI CARMOUCHE & KODY COPENHAVER WITH RACE TEAM CREW.



SRP Enterprises, Inc.

Factory Matched Number Kits that resist fuel, fading and scratches. UV coated for shine and protection from the sun. Includes 4 sets of A-Z, 0-9. Total of 146 decals. Size 3" letters.

Series 200	BLUE & BLACK 123ABC BLBKG200	SILVER & BLACK 123ABC SIBKG200	BURGUNDY & BLACK 123ABC RUBKG200
	SOLID BLACK 123ABC BLK200EC	SOLID WHITE 123ABC WHI200EC	
Series 300	BLUE & BLACK ABC123 BLBKG300	REAL CHROME & BLACK ABC123 CHBKG300	FOREST GREEN & BLACK ABC123 TEBKG300
	RED & BLACK ABC123 REBKG300	WHITE & BLACK ABC123 WHBKG300	SILVER & BLACK ABC123 SIBKG300
	YELLOW & BLACK ABC123 YEBKG300		
	SOLID BLACK ABC123 BLK350EC	SOLID RED ABC123 RED350EC	SOLID WHITE ABC123 WHI350EC
Series 305 EC			
Series 320	BROWN & BLACK ABC123 BRBLK320	GREEN & BLACK ABC123 TEBLK320	REAL GOLD GLITTER & BLACK ABC123 GOSPK320
	ORANGE RED & BLACK ABC123 ROBLK320	SILVER & BLACK ABC123 SIBLK320	

FOUR STROKE
INTAKE SYSTEMS
ENGINE/GASKETS
EXHAUST
DRIVE LINE HANDLING
ELECTRICAL
WATERLINE /BILGE
STEERING & CONTROLS
BODY
ACCESSORIES
SERVICE TOOLS /HARDWARE
CHEMICAL

IPD UNIVERSAL RACE NUMBER SET

These universal full-size race numbers use high quality vinyl for good durability, are designed with a strong width and are skewed for an aggressive look that looks fast sitting still. Each number comes as a left and right set, and each number is skewed the opposite direction, so appearance will be the same on both sides.

- Approximately 6 inches Tall
- Comes with Left & Right

White #	Part No.	Black #	Part No.
#0	RN-FS-UNI-WH-0	#0	RN-FS-UNI-BLK-0
#1	RN-FS-UNI-WH-1	#1	RN-FS-UNI-BLK-1
#2	RN-FS-UNI-WH-2	#2	RN-FS-UNI-BLK-2
#3	RN-FS-UNI-WH-3	#3	RN-FS-UNI-BLK-3
#4	RN-FS-UNI-WH-4	#4	RN-FS-UNI-BLK-4
#5	RN-FS-UNI-WH-5	#5	RN-FS-UNI-BLK-5
#6	RN-FS-UNI-WH-6	#6	RN-FS-UNI-BLK-6
#7	RN-FS-UNI-WH-7	#7	RN-FS-UNI-BLK-7
#8	RN-FS-UNI-WH-8	#8	RN-FS-UNI-BLK-8
#9	RN-FS-UNI-WH-9	#9	RN-FS-UNI-BLK-9



RACING NUMBERS

3 per package. 8" Tall. Black color only.

#	Part	#	Part
#0	H1310	#5	H1315
#1	H1311	#6	H1316
#2	—	#7	H1317
#3	H1313	#8	H1318
#4	H1314	#9	—

CARBON FIBER NUMBER PLATE BACKGROUNDS

Add style to your number plate background and still be race legal. 3 backgrounds per package.



Style	Yellow	White	Orange
Precut	7248	7249	—
Slanted	8248	—	8251
Universal	9248	—	9251



STICKER-ON! DECAL APPLICATION FLUID

No more bubbled on or wrinkled decals.

Description	Part No.
Sticker-On! 2 oz.	964



IPD DIGITALLY PRINTED GRAPHICS

IPD Digitally Printed Graphics offer full digital colors printed on premium materials, then coated with a thick crystal-clear protective laminate for superior color depth and optimum durability. Printed graphics can be a better option if you have never installed graphics before, since the multiple colors are printed in sections, resulting in fewer pieces and much easier installation.

HOW TO ORDER IPD GRAPHICS:

**GK
Graphic
Kit**

**Step 1
Design**

**Step 2
Model**

**Step 3
Accent
Color**

Hot Products IPD Graphics Kit includes: **Race Numbers** and **Racer Name**, which must be submitted with your order.

Step 1 - Design



GK-NS-SXR-SB

NS



GK-PW-SJ-RD

PW



GK-GH-FXSHOZ-YL

GH



GK-STB-FZR-RD

STB (Yamaha Only)



GK-BK-SXR-GN

BK



GK-KC-4550-RD

KC

Step 2 - Model

- SJ (Yamaha SuperJet)
- SNSJ (Yamaha Squarenose SuperJet)
- FXSHO2 (FX Series Yamaha Runabouts)
- FZR (FX Series Yamaha Runabouts)
- WB (Yamaha Waveblaster B1)
- SXR (Kawasaki SXR)
- ULT300 (Kawasaki Ultra 300-310)
- 4550 (Kawasaki 400/440/550)
- RXPX2 (Sea-Doo RXP-X 260)
- RXT (Sea-Doo Gen-1 RXT & GTX)

Step 3 - Accent Colors

Standard Accent Colors



Black Code: BK White Code: WH Grey Code: GY Blue Code: BU Sky Blue Code: SB Green Code: GN IPD Green Code: IG Orange Code: OR Pink Code: PK Purple Code: PR Red Code: RD Yellow Code: YL

*Fluorescent color upgrade is available for an extra charge (Fluorescent green, yellow, red, pink, red/orange, orange)



For more design and accent colors and models, please log on to www.IPDGraphics.com

FOUR STROKE
INTAKE SYSTEMS
ENGINE/GASKETS
EXHAUST
DRIVE LINE HANDLING
ELECTRICAL
WATERLINE /BILGE
STEERING & CONTROLS
BODY
SERVICE TOOLS ACCESSORIES /HARDWARE
CHEMICAL

AQUA Performance

AQUA PERFORMANCE "AQUA STEPS"

The spring-loaded stainless steel step stays in the upward position until needed for added safety benefits. The step features a soft marine foam covering for your non-slip protection and grip. It comes completely assembled with all stainless steel hardware.



Yamaha	Part No.
VX	Not Available
FX140, FX-HO (03-07)	Not Available
Wave Blaster (93-95) Wave Raider 701 (94)	1077Y-BLK
Wave Raider 701, 1100 (95)	1100YD-BLK
Wave Raider 701, 760, 1100 & STS (96-98)	1100WWD-BLK
Wave Runner III 650 (90-95)	1077Y3D-BLK
Wave Runner LX, VXR, Pro VXR (all years)	1070XL-BLK
Wave Venture 701/760/1100 (96-00)	1070XL-BLK
XL701/760 (98-03)	1070XL-BLK
XL800, XLT800 (00-03)	1072XL-BLK
XL1200 (98)	1070XL-BLK
XL1200, XLT1200 (99-04)	1072XL-BLK
XL1200 LTD (99-01)	1072XL-BLK
SUV 1200 (99-04)	2010SUV1

Honda	Part No.
Aquatrax F-12, F-12X, R12X (02-04)	2002ATX-BLK

Polaris	Part No.
SLH (98-01)	1096SLTX-BLK
SLTH (98-00)	1096SLTX-BLK
SLTX (96-00)	1096SLTX-BLK
SLXH (98-00)	1096SLTX-BLK
Virage, TX, TXI, Freedom (00-04)	1096SLTX-BLK
SLT 700 (96-99)	1075PDT-BLK
SLT 750 (95)	1075PDT-BLK
Hurricane All	1075PDT-BLK

Sea-Doo	Part No.
GS (97-02) GSI (97)	1098GS-BLK
GSX (96-00)	1096GXD-BLK
GTI, GTI LE (96)	1095XPD-BLK
GTI/GTI LE (97-04)	1097GTX-BLK
GTI, RFI (05)	2005RFI-BLK
GTI, GTI SE, GTI 130 (96-08)	2006GTI-BLK
GTS (94-96)	1077GD-BLK
GTS (97-00)	1098GTS-BLK
GTS (01-02)	1097GTX-BLK
GTX (94-95)	1077GD-BLK
GTX (96-03)	1097GTX-BLK
HX (95-98)	1085HXD-BLK
RX, RXDI (00-03)	1098GTS-BLK
RXP, RXP 215 & 115, RXP-X 255, RXT (04-07)	2004RXP-BLK
RXT-X 255HP (08-10)	2008RXT-BLK
RXT-X 260 (10-11), RXT-X aS 260	2010RXTX-BLK
SP (88-93) SPI (88-93) SPX (92-93)	1077S3D-BLK
SP (96) SPI (96-98)	1096SXD-BLK
SP (97-98)	1098SP-BLK
SPX (96-00), XP/XP DI (96-04)	1096SPD-BLK
XP, XPDI (95)	1095XPD-BLK

Kawasaki	Part No.
ZXI 750/900/1100 All	1090KZD-BLK
900STS (01)	1097KTX-BLK
STX 750/900/1100 (96-00)	1097KTX-BLK

FOUR STROKE	INTAKE SYSTEMS	ENGINE/ GASKETS	EXHAUST	DRIVE LINE HANDLING	ELECTRICAL	WATERLINE /BILGE	STEERING & CONTROLS	BODY	ACCESSORIES	SERVICE TOOLS /HARDWARE	CHEMICAL
----------------	-------------------	--------------------	---------	------------------------	------------	---------------------	------------------------	------	-------------	----------------------------	----------



RIVA RACING BOARDING STEP

Yamaha	Part No.
FX 140, FX-HO (03-07), FX Cruiser	MWV-FSTEP-FX-06
VX 110 Deluxe, VX110 Sports	MWV-FSTEP-VX-1



2015 FREERIDE WORLD CHAMPION MARK GOMEZ PRACTICING ON THE NEW 2016 RICKTER XFR. PHOTO COURTESY OF JIN OMURA.

FLOATING WRIST LANYARDS



A. Wrist Color	Orange	Black	Black	Purple
B. Lanyard Color	Silver	White	Orange	Green
Yamaha	A8152	A8154	A8156	-
KPTW	-	-	-	A2131

*KPTW stands for: KAWASAKI, POLARIS, TIGERSHARK, WET JET



A. Wrist Color	Black	Black	Purple	Yellow	Yellow	Black	Blue	Green	Red	Red
B. Lanyard Color	Black	Neon Red	Yellow	Purple	Black	Silver	Black	Black	White	Black
KPTW*	A2137	A2136	A2141	A2133	A2128	A2126	A2143	A2149	A2125	A2148
Yamaha	A8147	A8146	A8151	A8143	A8153	A8136	A8139	-	A8155	A8158
Sea-Doo**	A7467	A7466	-	-	-	-	-	-	-	-

*KPTW stands for: KAWASAKI, POLARIS, TIGERSHARK, WET JET

**These Atlantis Sea-Doo lanyards are not compatible with the Sea-Doo Spark.

ULTRA VEST FLOATING LANYARDS



Description	Black	Red	Yellow	Purple	Silver	Blue	Green	White	Orange	Pink
KPTW*	A2109	A2103	A2097	A2106	A2096	A2107	A2101	A2108	A2105	A2100
Yamaha	A8130	A8123	A8133	A8128	A8134	A8129	A8121	A8124	A8127	A8120
Sea-Doo	A7459	A7453	A7447	-	-	A7457	-	-	-	-

*KPTW stands for: KAWASAKI, POLARIS, TIGERSHARK, WET JET

**These Atlantis Sea-Doo lanyards are not compatible with the Sea-Doo Spark.

PRO FLOATING WRIST LANYARDS



Description	Black	Red	Orange	Silver
KPTW	A2109-PF	A2103-PF	A2105-PF	A2096-PF
Yamaha	A8130-PF	A8123-PF	A8127-PF	A8134-PF

*KPTW stands for: KAWASAKI, POLARIS, TIGERSHARK, WET JET

SEA-DOO DESS COMPATIBLE WRIST LANYARDS

Atlantis is proud to offer the only aftermarket lanyards that are compatible with the Sea-Doo's DESS system. These lanyards fit Sea-Doo watercrafts, Jet Boats, and Snowmobiles from 1996 to current (except '96 XP & GTI). Program with factory programmer. **These Atlantis Sea-Doo lanyards are not compatible with the Sea-Doo Spark.**

A. Wrist Color B. Lanyard Color	Yellow Black	Orange White	Black Orange	Black Silver	Black White	Black Neon Yellow
Sea-Doo Dess	A7473-DSC	A7477-DSC	A7476-DSC	A7480-DSC	A7474-DSC	A7485-DSC
A. Wrist Color B. Lanyard Color	Black	Red	Yellow	Silver	Blue	Orange
Sea-Doo Dess	A7459-DES	A7453-DES	A7447-DES	A7445-DES	A7457-DES	A7455-DES



PERFORMANCE LANYARDS

Atlantis has created the "Performance" lanyard from the suggestions and feedback from Pro Racers, Freestylers, and Freeriders. This lanyard features the float tube at the rear point of the lanyard next to the vest clip. This location modification keeps the area around the key almost weightless and free of any extra objects that may come in contact with water during aggressive riding which sometimes causes the key to pull out unwillingly.

Description	Part No.
KPTW*	A2103P
Yamaha	A8123P

*KPTW stands for: KAWASAKI, POLARIS, TIGERSHARK, WET JET



PRO FLOATING LANYARD WRIST BAND

Now available by itself, is our deluxe floating wristband made from marine grade webbing, neoprene, and Velcro. It attaches easily to any clip lanyard and gives the rider a sense of security he has been looking for.

Description	Black	Red	Yellow	Silver
Wristband	A2070	A2072	A2074	A2077



KAWASAKI JET SKI LANYARD AND SWITCH

This factory Kawasaki switch allows you to use a safety lanyard. On all year Kawasaki JS440/JS550/550SX/750SX/750SXI/800SXR. Easy and quick to install, usually takes less than 5 minutes. Replaces your original switch face plate to allow for use of a lanyard. Factory Kawasaki part, so you know it's the highest quality and will last!

Description	Part No.
Switch with Lanyard Neon Green	AZ1030NG



CLIP ON SAFETY WHISTLE

Description	Black	Red	Yellow
Clip On Whistle	A2700C	A2701C	A2706C



ATLANTIS KEY FLOATS

Description	Part No.
Red	A1951
Blue	A1952
Yellow	A1953

FOUR
STROKEINTAKE
SYSTEMSENGINE/
GASKETS

EXHAUST

DRIVE LINE
HANDLING

ELECTRICAL

WATERLINE
/BILGESTEERING
& CONTROLS

BODY

SERVICE TOOLS
ACCESSORIES
/HARDWARE

CHEMICAL



ECONOMY WRIST LANYARDS FOR SEA-DOO

Economy price lanyards. For Sea-Doo (Non-DESS) only.

Description	Part No.
Sea-Doo Wrist Lanyard Purple/Green	WJ7094PU
Sea-Doo Wrist Lanyard Green/Purple	WJ7094GR
Sea-Doo Wrist Lanyard Blue/Green	WJ7094B



JET LOGIC ULTIMATE PWC SAFETY LANYARDS

The Ultimate PWC safety lanyard has it all! 3 keys to fit ALL brands: Sea-Doo, Yamaha, Kawasaki, Polaris, Tiger Shark and Wet Jet. *Excluding the Sea-Doo DESS System.

Description	Part No.
Yellow/Purple	UL-1
Black/Red	UL-2



JET LOGIC SAFETY WHISTLE ON FLOATING LANYARD

An audible signal device is required on boats and personal watercraft in most states. A high pitch pealess whistle is a good choice. Clip it onto your life jacket or safety lanyard. Doubles as a floating key chain!

Description	Color	Part No.
Jet Logic Safety Whistle	Purple/Yellow	W-1
Jet Logic Safety Whistle	Red/Black	W-2



SHOP LANYARDS

Not legal for riding. For shop testing only. These can easily be attached to your belt while working on all PWC and jet boats.

Description	Part No.
KPTW, Yamaha, Sea-Doo	A3240
KPTW, Yamaha, Sea-Doo DESS	A3250

*KPTW stands for: KAWASAKI, POLARIS, TIGERSHARK, WET JET. **These Atlantis Sea-Doo lanyards are not compatible with the Sea-Doo Spark.



WSM LANYARDS

For Sea-Doo 900 Spark (2014-15), OEM #278002843

Description	Part No.
Sea-Doo Spark Lanyard	012-575



HARDLINE LIFE VEST HANDLES

Comfortable Grip Handles for Tandem PWC Riding. Helps your passengers hold on better!

- Easily attaches to PFD (life vest)
- Contoured grip design for better hold
- Swivel hooks
- 2 handles per set

LIFE VEST NOT INCLUDED

Description	Part No.
Life Vest Handles	VS-1



2015 QUAKYSENSE WORLD FINALS AMATEUR FREESTYLE CHAMPION
TANNER THOMAS WITH THE RICKTER-RRP TEAM.
PHOTO COURTESY OF JIN OMURA.

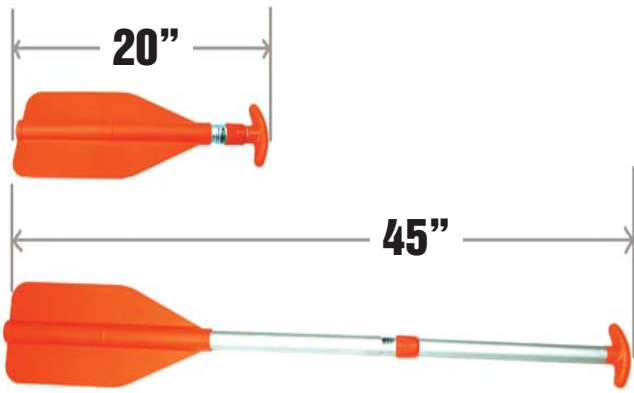

TELESCOPING PADDLES

Lightweight paddles adjust easily to variable lengths with a simple twist. A section of the aluminum shaft disappears inside the blade for the ultimate in compact storage under boat seats or in PWC storage compartments. 20-45 inch long.

Description
Telescoping Paddle

Part No.
P-1



These Leg Deflectors fit great, stay in place while riding and are extremely comfortable.

LEG DEFLECTOR

Made in England

Description
Leg Deflector

Part No.
70-4012



TAK SAITO WORKING THE HOT PRODUCTS VIP BOOTH AT THE 2015 QUAKYSENSE WORLD FINALS IN LAKE HAVASU CITY, ARIZONA. PHOTO COURTESY OF JIN OMURA.

Goggle GRIP



Clear



Black



Lime Green



White



Smoke

GOGGLE GRIP

- The original Goggle Grip® designed for personal watercraft racers
- Secures goggle strap on both sides of the helmet
- Lift and secure goggles on top of helmet between races
- 3M VHB™ adhesive peel-and-stick application
- 24-hour curing time
- Designed for standard 1.5" goggle straps

Description	Color	Part No.
Goggle Grip	Clear	70-4040
Goggle Grip	Black	70-4041
Goggle Grip	Smoke	70-4044
Goggle Grip	White	70-4045
Goggle Grip	Lime Green	70-4046

Sold in sets of 2



Military, Law Enforcement, Ski and Snowboard versions are available for bulk shipment only. Please contact us for details.

FOUR
STROKE

INTAKE
SYSTEMS

ENGINE/
GASKETS

EXHAUST

DRIVE LINE
HANDLING

ELECTRICAL

WATERLINE
/BILGE

STEERING
& CONTROLS

BODY

ACCESSORIES

SERVICE TOOLS
/HARDWARE

CHEMICAL

FOUR STROKE
INTAKE SYSTEMS
ENGINE/GASKETS
EXHAUST
DRIVE LINE HANDLING
ELECTRICAL
WATERLINE /BILGE
STEERING & CONTROLS
BODY
SERVICE TOOLS ACCESSORIES
/HARDWARE
CHEMICAL



BURN JOHN WET SUIT

Color	Size	Part No.
White/Red/Black	Small	BRN-1003-WHT/BLK/RED-SM
White/Red/Black	Medium	BRN-1003-WHT/BLK/RED-MD
White/Red/Black	Large	BRN-1003-WHT/BLK/RED-LG
White/Red/Black	X-Large	BRN-1003-WHT/BLK/RED-XL

BURN RETRO JOHN WET SUIT

Color	Size	Part No.
Black/Green	Small	BRN-1070-BLK/GRN-SM
Black/Green	Medium	BRN-1070-BLK/GRN-MD
Black/Green	Large	BRN-1070-BLK/GRN-LG
Black/Green	X-Large	BRN-1070-BLK/GRN-XL

Burn Wet Suit Specifications:

- Surf suit-inspired cut
- 2mm & 3mm
- Molded rubber knee pads
- Burn Industries' "super stretch" neoprene allows for a tight fit without sacrificing movement and comfort
- *No jacket currently available*

Burn Wetsuit Sizing:

Small: 34"-37" chest, 27"-30" waist, 5'4"-5'7" height
 Medium: 36"-39" chest, 30"-32" waist, 5'7"-5'9" height
 Large: 39"-41" chest, 32"-34" waist, 5'9"-5'11" height
 X-Large: 41"-43" chest, 34"-36" waist, 5'11"+ height

BURN WARBIRD YELLOW GRUNGE JOHN WET SUIT

Color	Size	Part No.
Black/Yellow	Small	BRN-1005-BLK/YEL-SM
Black/Yellow	Medium	BRN-1005-BLK/YEL-MD
Black/Yellow	Large	BRN-1005-BLK/YEL-LG
Black/Yellow	X-Large	BRN-1005-BLK/YEL-XL

BURN GRUNGE 3-COLOR NITRO VEST

Description	Size	Part No.
Black/Yellow	Small	BRN-1072-BLK/YEL-SM
Black/Yellow	Medium/Large	BRN-1072-BLK/YEL-MD/LG
Black/Yellow	X-Large	BRN-1072-BLK/YEL-XL
Black/Yellow	XX-Large	BRN-1072-BLK/YEL-XXL
Black/Yellow	XXX-Large	BRN-1072-BLK/YEL-XXXL

3-Color Burn Grunge Nitro Vest Sizing:

SM: 23-27" MD/LG: 32-39" XL: 39-43" XXL: 43-47" XXXL: 47-51"



INKED SUIT

BURN INKED WET SUIT

- Full length bodysuit • Inked Up artwork
- Molded rubber knee pads • 3mm

Color	Size	Part No.
Inked Up	Small	BRN-1002-WHT/BLK-SM
Inked Up	Medium	BRN-1002-WHT/BLK-MD
Inked Up	Large	BRN-1002-WHT/BLK-LG



BURN GRUNGE 3-COLOR NITRO VEST

- Burn Industries' molded "Air foam" vest
- Side entry • Single buckle
- Reduced front panel for comfort
- As worn by top athletes Dustin Motz and Jake Montandon

Description	Size	Part No.
Green	Small	BRN-1072-GRN-SM
Green	Medium/Large	BRN-1072-GRN-MD/LG
Green	X-Large	BRN-1072-GRN-XL
Green	XX-Large	BRN-1072-GRN-XXL
Green	XXX-Large	BRN-1072-GRN-XXXL
Black/Yellow	Small	BRN-1072-BLK/YEL-SM
Black/Yellow	Medium/Large	BRN-1072-BLK/YEL-MD/LG
Black/Yellow	X-Large	BRN-1072-BLK/YEL-XL
Black/Yellow	XX-Large	BRN-1072-BLK/YEL-XXL
Black/Yellow	XXX-Large	BRN-1072-BLK/YEL-XXXL

3-Color Burn Grunge Nitro Vest Sizing:

SM: 23-27" MD/LG: 32-39" XL: 39-43" XXL: 43-47" XXXL: 47-51"



NEW BURN NITRO 2-COLOR VEST

Description	Size	Part No.
Black/Blue	Small/Medium	BRN-1011-BLK/BLU-SM/MD
Black/Blue	Large/X-Large	BRN-1011-BLK/BLU-LG/XL
Black/Blue	XX-Large	BRN-1011-BLK/BLU-XXL
Blue	Large/X-Large	BRN-1011-BLU-LG/XL
Blue	XX-Large	BRN-1011-BLU-XXL
Blue	XXX-Large	BRN-1011-BLU-XXXL
Yellow/Red	Small/Medium	BRN-1011-YEL/RED-SM/MD
Yellow/Red	XX-Large	BRN-1011-YEL/RED-XXL
Yellow/Red	XXX-Large	BRN-1011-YEL/RED-XXXL

Burn Nitro 2-Color Vest Sizing:

SM/MD: 23-27" LG/XL: 32-39" XXL: 43-47" XXXL: 47-51"



BURN NITRO 2-COLOR VEST

Description	Size	Part No.
Red	Small/Medium	BRN-1001-RED-SM/MD
Red	Large/X-Large	BRN-1001-RED-LG/XL
Red	XX-Large	BRN-1001-RED-XXL
Blue	Large/X-Large	BRN-1001-BLU-LG/XL
Blue	XX-Large	BRN-1001-BLU-XXL
Blue	XXX-Large	BRN-1001-BLU-XXXL
Yellow	Small/Medium	BRN-1001-YEL-SM/MD
Yellow	XX-Large	BRN-1001-YEL-XXL
Yellow	XXX-Large	BRN-1001-YEL-XXXL

Burn Nitro 2-Color Vest Sizing:

SM/MD: 23-27" LG/XL: 32-39" XXL: 43-47" XXXL: 47-51"



BURN MAGNETO MENS VEST

- Fully segmented 2-buckle neoprene vest
- Hinge-type closure system
- Designed for comfort with optimal floatation
- Hidden webbing detail

Description	Size	Part No.
Red/Black	Small	BRN-1007-RED/BLK-SM
Red/Black	Medium	BRN-1007-RED/BLK-MD
Red/Black	Large	BRN-1007-RED/BLK-LG
Red/Black	X-Large	BRN-1007-RED/BLK-XL

Burn Magneto Mens Sizing:

SM: 33-38" MD: 38-42" LG: 42-45" XL: 45-49" XXL: 49-53"



RETRO VEST

Description	Size	Part No.
Retro Green	Small	BRN-1004-BLK/GRN-SM
Retro Green	X-Large	BRN-1004-BLK/GRN-XL
Retro Green	XX-Large	BRN-1004-BLK/GRN-XXL

Retro Vest Mens Sizing:

XXS: 28-30" XS: 30-33" SM: 33-37" MD: 37-41" LG: 41-45"
XL: 45-49" XXL: 49-53" XXXL: 53-57"

Burn Industries PFD (Personal Flotation Device) have been extensively tested to meet and/or exceed all safety requirements and have received certification by the US Coast Guard, CE and Australian Standards.



BURN CORE VEST



- Burn starter vest • 4-buckle vest
- Nylon material • Lanyard loop • Unisex sizing

Description	Size	Part No.
Red/Black	Small	BRN-1006-RED/BLK-SM
Red/Black	Medium	BRN-1006-RED/BLK-MD
Red/Black	Large	BRN-1006-RED/BLK-LG
Red/Black	X-Large	BRN-1006-RED/BLK-XL
Red/Black	XX-Large	BRN-1006-RED/BLK-XXL

Burn Nitro Vest Sizing:
SM: 31-35" MD: 35-39" LG: 39-43" XL: 43-47" XXL: 47-51"

BURN MAGNETO LADIES VEST



- Fully segmented 2-buckle neoprene vest
- Designed specifically to fit a woman's body
- Hidden webbing detail

Description	Size	Part No.
Hot Pink X-Small		BRN-1071-HPNK-XSM
Hot Pink Small		BRN-1071-HPNK-SM
Hot Pink Medium		BRN-1071-HPNK-MD
Hot Pink X-Large		BRN-1071-HPNK-XL

Burn Magneto Ladies Sizing:
XSM: 30-33" SM: 33-37" MD: 37-40" L: 40-44" XL: 44-48"



BURN MENS/WOMENS SKI VEST

- 2-buckle neoprene vest
- Hidden webbing detail
- 10mm rear panel allows for better comfort

Description	Size	Part No.
Black	XX-Small	BRN-1008-BLK-XXS
Black	X-Small	BRN-1008-BLK-XS
Black	Small	BRN-1008-BLK-SM
Black	Medium	BRN-1008-BLK-MD
Black	Large	BRN-1008-BLK-LG
Black	X-Large	BRN-1008-BLK-XL
Black	XX-Large	BRN-1008-BLK-XXL
Black	XXX-Large	BRN-1008-BLK-XXXL

Burn Ski Vest Sizing:
XXS: 28-30" XS: 30-33" SM: 33-37" MD: 37-41" LG: 41-45"
XL: 45-49" XXL: 49-53" XXXL: 53-57"

BURN MENS/WOMENS SKI VEST LIMITED EDITION



- 2-buckle neoprene vest
- Hidden webbing detail
- 10mm rear panel allows for better comfort
- Edgy colorways

Description	Size	Part No.
Black/Yellow	Small	BRN-1009-LTD-YEL/BLK-SM
Black/Yellow	Medium	BRN-1009-LTD-YEL/BLK-MD
Black/Yellow	Large	BRN-1009-LTD-YEL/BLK-LG
Black/Yellow	X-Large	BRN-1009-LTD-YEL/BLK-XL
Black/Yellow	XX-Large	BRN-1009-LTD-YEL/BLK-XXL

Burn Nitro Vest Sizing:
SM: 31-35" MD: 35-39" LG: 39-43" XL: 43-47" XXL: 47-51"



BURN TOUR COAT

Color	Size	Part No.
Black/Red	Small	BRN-1085-SM
Black/Red	Medium	BRN-1085-MD
Black/Red	Large	BRN-1085-LG
Black/Red	X-Large	BRN-1085-XL
Black/Red	2X-Large	BRN-1085-2XL



WARBIRD LYCRA



RETRO LYCRA

BURN LYCRA RASH GUARD

- UV-resistant lycra construction • 4-way stretch • Quick drying

Color	Size	Part No.
Retro	Small	BRN-1081-BLK/WHT-SM
Retro	Medium	BRN-1081-BLK/WHT-MD
Retro	Large	BRN-1081-BLK/WHT-LG
Retro	X-Large	BRN-1081-BLK/WHT-XL
Retro	XX-Large	BRN-1081-BLK/WHT-XXL
Warbird	Small	BRN-1080-WHT/BLK/YEL-SM
Warbird	Medium	BRN-1080-WHT/BLK/YEL-MD
Warbird	Large	BRN-1080-WHT/BLK/YEL-LG
Warbird	X-Large	BRN-1080-WHT/BLK/YEL-XL
Warbird	XX-Large	BRN-1080-WHT/BLK/YEL-XXL

BURN BOARD SHORTS

- 4-way stretch • Drawstring
- Pocket with drainage
- Super cool artwork



Color	Size	Part No.
Multi	32	KOM-1101-BSPSY32
Multi	34	KOM-1101-BSPSY34
Multi	36	KOM-1101-BSPSY36
Multi	38	KOM-1101-BSPSY38

BURN CAP

- Flat-bill style • Branded inner piping
- OSFA • Color: Green Camo



Size	Part No.
Full	KOM-1090-CPCRSCAMO

Burn Industries PFD (Personal Flotation Device) have been extensively tested to meet and/or exceed all safety requirements and have received certification by the US Coast Guard, CE and Australian Standards.



BT111



BT112



BT113

BUTTER BOMBS

Frame	Lens	Foam	Part No.
Matte Black	Smoke Polarized	Gray	BT111
Matte Tortoise	Brown Polarized	Black	BT112
Glossy White	Smoke Polarized	Gray	BT113



IRE101-BM



IRE103-BM



IRE114

IRIE-BOMBS

Frame	Lens	Foam	Part No.
Matte Black	Blue Mirror PC*	Gray	IRE101-BM
Glossy White	Blue Mirror PC*	Gray	IRE103-BM
2-Tone Crystal Smoke	Mirror Polarized	Gray	IRE114

*PC: Polycarbonate



BOMBER GOGGLES FOR RECREATIONAL RIDING

Frame	Anti-Fog Safety Lens	Part No.
Black	Clear	BUG101
Black	Smoke	BUG102
White	Clear	BUG103
White	Smoke	BUG104

BOMBER FLOATING EYEWEAR



GM101



Mark "Gomer" Gomez



GM101-BM



GM102-YM



GM103-BM



GM111



GM112



GM113

GOMER BOMBS

Frame	Lens	Foam	Part No.
Matte Black	Smoke PC*	Gray	GM101
Matte Black	Blue Mirror PC*	Gray	GM101-BM
Matte Tortoise	Yellow Mirror PC*	Black	GM102-YM
Glossy White	Blue Mirror PC*	Gray	GM103-BM
Matte Black	Smoke Polarized	Gray	GM111
Matte Tortoise	Brown Polarized	Black	GM112
Glossy White	Smoke Polarized	Gray	GM113

*PC: Polycarbonate



BG111



BG111GM-GF



BG114

BOOGIE-BOMBS

Frame	Lens	Foam	Part No.
Matte Black	Smoke Polarized	Gray	BG111
Matte Black	Green Mirror Polarized	Green	BG111GM-GF
2-Tone Crystal Smoke	Silver Mirror Polarized	Gray	BG114

FOUR STROKE
INTAKE SYSTEMS
ENGINE/GASKETS
EXHAUST
DRIVE LINE HANDLING
ELECTRICAL
WATERLINE /BILGE
STEERING & CONTROLS
BODY
ACCESSORIES
SERVICE TOOLS
HARDWARE
CHEMICAL

DRYPAK



DRY PAK CELL PHONE GPS MP3 CASE

Take photos through clear window on back!

DRY PAK SMART PHONE, GPS, MP3 COVER

Fits iPhone 6, 6 plus and Note!

Description	Part No.
Dry Pak Case 4" x 6" Yellow/Blue	DP-46
Dry Pak Case 4" x 6" White/Grey	DP-46W

Description	Part No.
Dry Pak Case 4" x 7" White/Grey	DP-47W



DRY PAK MULTI-PURPOSE CASE

Description	Part No.
Dry Pak Case 4" x 8" Yellow/Blue	DP-48
Dry Pak Case 4" x 8" White/Grey	DP-48W



DP-58W, DP-58 DRY PAK SMART PHONE, GPS/PDA GAME PLAYER CASE

Description	Part No.
Dry Pak Case 5" x 8" Yellow/Blue	DP-58
Dry Pak Case 5" x 8" White/Grey	DP-58W



DRY PAK MULTI-PURPOSE CASE

Holds electric touch pad.

Description	Part No.
Dry Pak Case 9" x 12"	DPC-912



DRY PAK TABLET CASE FOR IPAD

Listen to Music or Movies with the Included Ear Phone Jack!

Holds electric touch pad.

Description	Part No.
Dry Pak Tablet Case for iPad 9" x 12"	DPT-912W



3.5" x 7.5"



DELFINO MP-IPHONE DRY CASE

Specifically Designed for the I-Phone and I-Pod and can be used with an ear piece.

Description	Part No.
Delfino I-phone Dry Case	IPWP-001



WB-1
WB-4
WB-7



WB-9

"DRY PAK" DRY BAGS

Versatile and durable, your gear will stay dry inside these round bottom dry bags, even in adverse conditions. Shut out water by rolling down the top a few times and snapping the side release buckles together. The yellow and blue bags are constructed of extra heavy-duty vinyl /polyester tri-laminate with RF-welded seams. It's quick and easy to find items inside the clear bags, made of durable waterproof 19 oz. vinyl with RF-welded seams.

Description	Color	Part No.
9.5" Diam. x 16"	Yellow	WB-1
11.5" Diam. x 19"	Yellow	WB-4
12.5" Diam. x 28"	Yellow	WB-7

Description	Color	Part No.
12.5" Diam. x 28"	Clear	WB-9

VIEWTAINER

Made in the U.S.A



VIEWTAINER

Ideal to keep your registration papers safe & dry. They are great to carry small tools/supplies, etc.

Description	Part No.
2" x 6" Green	CC26-GRN

Description	Part No.
2.75" x 8" Blue	CC27508-BLU
2.75" x 8" Yellow	CC27508-YLW
2.75" x 8" Black	CC27508-BLK

HYDRO-TURF DRY BOX

Keep your registration papers and small tools/supplies dry and safe. Actual product is black color only.

Description	Part No.
Dry Box 6" x 8.5" <i>Color is Black</i>	BOX



DRAWSTRING MESH BAG

Size 20" x 30"

Description	Part No.
Drawstring Mesh Bag	69-1003



DOC ALLEN'S VERSATOOL The Swiss Army Knife of Hand Tools!

- Lightweight
- Compact
- Multi-Function
- Stainless Steel
- Use in Tight Places

Description	Part No.
Compact Tool Set	VERSATOOL

FOUR STROKE
INTAKE SYSTEMS
ENGINE/GASKETS
EXHAUST
DRIVE LINE HANDLING
ELECTRICAL
WATERLINE /BILGE
STEERING & CONTROLS
BODY
ACCESSORIES
SERVICE TOOLS /HARDWARE
CHEMICAL

FOUR STROKE
 INTAKE SYSTEMS
 ENGINE/GASKETS
 EXHAUST
 DRIVE LINE HANDLING
 ELECTRICAL
 WATERLINE /BILGE
 STEERING & CONTROLS
 BODY
 SERVICE TOOLS ACCESSORIES /HARDWARE
 CHEMICAL



ATLANTIS ANCHOR BAG

Our newly redesigned bag anchor is strong as ever but with bright new colors, rope, float, and hook. Just fill with rocks and sand for your anchoring needs. Fits easily into any storage compartment.

Description	Part No.
Anchor Bag (regular)	A2381



ATLANTIS LARGE ANCHOR BAG

This new bag is twice as large as our standard bag. It has sewn-in handles for ease in moving and emptying. Designed for 3 & 4 passenger PWC or mini-jet boats.

Description	Part No.
Large Anchor Bag	A2394



PWC SAND ANCHOR & BUOY

A sand anchor is ideal for anchoring PWCs in shallow water to keep the impeller off the beach. Fill this super durable tri-laminate anchor bag with up to 35 pounds of rocks or sand. A buoy marks the anchor's location. Tie-ups are easy with the 6-foot long rope and the oversized finish-friendly acetyl snap hook.

Description	Part No.
Jet Logic Sand Anchor & Buoy	A-1



KWIK TEK COMPLETE FOLDING ANCHOR SYSTEM

3-1/3 Lb 4-fluke folding anchor and 25ft. long marine grade rope.

Description	Part No.
Complete Anchor System	A-2



ATLANTIS STAKE ANCHOR

Needing an easy way to keep your personal watercraft tied to a shore? Here it is, just screw the stake into the ground and you have 15' to tether your boat to shore. Easy to store and take with you.

Description	Part No.
Stake Anchor	A2384



GIANT SNAP HOOK

Perfect for attaching ski lines, dock lines, tow lines, or any rope up to 1/2 inch diameter.

Description	Part No.
Giant Snap Hook	A1945



ATLANTIS MUSHROOM ANCHOR

Comes with an 8 lb. mushroom anchor, 15' of nylon rope, a high-visibility plastic float & plastic clip. Perfect for anchoring in shallow water.

Description	Part No.
Mushroom Anchor 8 lbs.	A2380RD

**Due to the weight of this product it is not covered by the Hot Products shipping policy.*



ATLANTIS PWC HEAVY DUTY ANCHOR KIT

This new anchor system is for the 3 & 4 seat passenger PWCs or someone wanting extra holding power! It comes with a 6 1/2 lb. anchor, rope, float and bag.

Description	Part No.
Heavy Duty Anchor Kit 6-1/2 lbs.	A2389RD

**Due to the weight of this product it is not covered by the Hot Products shipping policy.*



ATLANTIS JET BOAT ANCHOR KIT

A high quality anchor designed with jet boats in mind. These steel anchors come with 4-5' of chain. They are vinyl coated to prevent corrosion and scratched hulls. 75-

100' nylon rope is securely attached to the chain with a galvanized shackle to let you anchor deep water. Brass ring on anchor helps you maneuver anchor out of tight spots and off snags. Can also be used as an emergency tow rope. Comes with storage bag.

Description	Part No.
6-1/2 lb. with 4' Chain & 75' Rope - 16 Foot Boats	A2388RD
11 lb. with 5' Chain & 100' Rope - 16-24 Foot Boats	A2393RD

**Due to the weight of this product it is not covered by the Hot Products shipping policy.*

NEW



ANCHOR BUNGEE LITE

Now you can tether your PWC off shore, so you don't have to risk damage from a rocky shore line. When you attach your anchor to an Anchor Bungee Lite, you are able to set the anchor 15' to 22' off shore and still able to pull the PWC close to shore to unload. Once you release the PWC, the bungee will pull the PWC away from shore, and you just need to tether the PWC on shore. Anchor Bungee Lite takes the shock out of your anchor line and makes it much easier to anchor offshore. The Anchor Bungee Lite stretches, while your anchor stays set. It has a much stronger tensile strength than others and is much more visible with the bright color scheme we offer. Stretches from 7' to 22'.

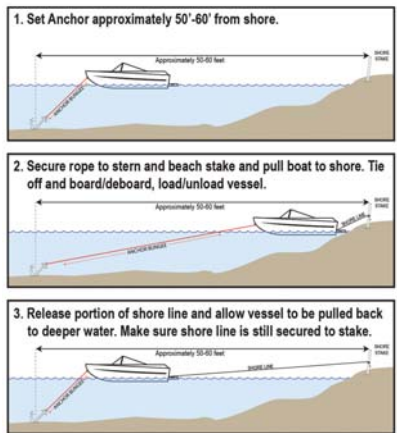

Description

Anchor Bungee Lite for PWC Dock Line

NEW

Part No.

AHAB-2



BUNGEE DOCK LINES

Airhead Bungee Dock Lines absorb shock to boats, cleats, pylons and other hardware. The bungee cord is hidden inside the rope and acts as a built-in snubber. Two foam floats protect the boat from chafing. 4 feet, stretches to 5-1/2 feet.

Description

Bungee Dock Line

Part No.

AHDL-4



PWC DOCK LINE

This dock line features a 10" loop on one end for securing a personal watercraft to dock cleats. The opposite end of the dock line features a strong plastic clip for easy connections or disconnection to the personal watercraft OEM hooks. The dock line total length is 7 feet. 2 dock lines per package.

Description

PWC Dock Line

Part No.

PWCD-2

WORLD'S BEST PWC FENDER

Front

HULL HUGR PWC FENDER

Rear

Docking a PWC has never been safer with the introduction of the HULL HUGR PWC Fender. Engineered specifically for PWCs, it hinges in the center to better protect PWC bodies from docks designed for bigger boats. We recommend 2 fenders per PWC. Fits all PWCs.

Description
Hull Huger PWC Fender

Part No.
HH-P1B



3" X 5" ROPE FLOAT

Need a way to mark an area? Need to float a rope for docking? Here is your answer, our easy to use rope floats. Fits up to a 1/2" diameter rope.

Description

Red/White

Blue/White

Part No.

A-1974

A-1975



KWIK TEK 20" DIAMETER BUOY

The affordable alternative! These durable 20" diameter inflatable buoys are perfect for marking anchors, moorings, hazards, swimming areas, or for setting up a personal watercraft or sailboat race course. They deflate quickly and easily for space efficient storage.

Description

Yellow Buoy 20"

Red Buoy 20"

Part No.

B-20Y

B-20R

FOUR STROKE	INTAKE SYSTEMS	ENGINE/GASKETS	EXHAUST	DRIVE LINE HANDLING	ELECTRICAL	WATERLINE /BILGE	STEERING & CONTROLS	BODY	ACCESSORIES	SERVICE TOOLS	CHEMICAL
-------------	----------------	----------------	---------	---------------------	------------	------------------	---------------------	------	-------------	---------------	----------

FOUR
STROKEINTAKE
SYSTEMSENGINE/
GASKETS

EXHAUST

DRIVE LINE
HANDLING

ELECTRICAL

WATERLINE
/BILGESTEERING
& CONTROLS

BODY

SERVICE TOOLS
ACCESSORIES
/HARDWARE

CHEMICAL



HEAVY DUTY TUBE ROPE

This heavy tournament quality 3/8" 16-strand braided tow rope is rated at 2375 lbs. tensile strength for 1 and 2 riders. 60 feet.

Description	Part No.
Deluxe Tube Rope	AHTR-60



4000LB TUBE ROPE

This heavy duty 9/16" x 60ft. tube rope is rated at over 4375 lbs. tensile strength for 3 and 4 riders.

Description	Part No.
4000lb Tube Rope	AHTR-4000



6000LB TUBE ROPE

This super strength 16 strand, 7/8 inch x 60 foot tube tow rope is rated at 6,000 pounds tensile strength! It's the strongest tube rope your money can buy, and is engineered to pull 5 or more riders.

Description	Part No.
6000 lb Tube Rope	AHTR-6000



WAKEBOARD ROPE

This wakeboard rope has a head turning 15 in. "Squid" patterned EVA grip wrapped around a floating aluminum core. The 5/16 inch, 16 strand, UV treated low stretch rope has 3 sections for wakeboarding at 45, 55 or 65 feet. Full length finger guards help create a comfortable split finger grip. A Rope Keeper is included for tangle-free storage.

Description	Part No.
Wakeboard Rope	AHWR-3

AIRHEAD® KWIK-CONNECT™

Conveniently attach and detach tube tow ropes to towables with AIRHEAD's KWIK-CONNECT. There's no need to thread 60 feet of rope through the tow strap each time you connect or disconnect a tow rope. The high impact KWIK-CONNECT has a 1 inch diameter hole to accept up to 6,000 lb. break strength tube ropes. Recommended for 1 to 4 rider towables that are not equipped with Kwik-Connects.



Description	Part No.
Kwik-Connect	AHKC-1



AIRHEAD HEAVY DUTY TOW HARNESS

This heavy duty tow harness is perfect for pulling skiers, wake boarders and up to 4 rider towables. Simply clip it onto your boat with the 5,000-pound tensile strength hooks, and attach your ski or tube rope to the heavy duty Kwik-Connect. A 6" float keeps the Kwik-Connect floating on top, away from your propeller. 12 feet long to fit larger boats and pontoons. Yellow / Red.

Description	Part No.
Airhead Tow Harness	AHTH-2



20' TOW ROPE

This 20 ft. tow rope has a heavy-duty carabiner at each end. The 12" long "soft hook" doubles as a rope wrap for neat storage. The 3/8" diameter rope is purple/yellow/red.

Description	Part No.
20' Tow-Rope	TR-20



AIRHEAD LINE WINDER

No more tangled lines with this classic styled floating line winder! It's easy to wind and neatly stow away anchor lines, mooring lines, ski ropes and tube ropes. Get a few for the garage too. Organize your extension cords, wires, clotheslines and Christmas lights once and for all. It's constructed of high impact polypropylene for extra long service. Color: Red. Ropes not included.

Description	Part No.
Airhead Rope Winder	AHLW-1



STIK-A-FLAG™ SKIER DOWN FLAG

The bright orange 420 denier nylon skier down flag is mounted to a 24" flag. PWCs with Kwik Tek's giant 3-1/4" suction cup. Required in AZ, CA, CO, ID, MO, NE, NM, OR, TX, UT & WA. Recommended everywhere for safety.

Description	Part No.
Skier Down Flag	SAF-1



IMPELLER PROTECTOR & KICK-BACK PROTECTOR

Specially designed for use on a personal watercraft, this Jet Logic protector reduces the possibility of the tow/ski rope of being sucked up inside the PWC's pump and impeller. This protector also protects PWC passengers from tow/ski rope kicking back when the rider falls.

Description	Part No.
24" long for PWC	IP-24



TRANSOM MOUNT SKI TOW HOOK

Our transom-mount ski tow is made from highly polished 304 stainless steel. A full stainless steel back plate distributes pressure evenly to prevent gel coat crazing. Tows are supplied with stainless steel nuts and star lock washers.

Description	Part No.
3/8" stock, 2-1/2" diam 4" legs, 2-1/2" transom	59-3437

AIRHEAD® 120 VOLT HI-PRESSURE AIR PUMP

You'll enjoy the performance of this 120 volt air pump. It inflates and deflates quickly and effectively. Peak pressure is 2.5 psi, plenty of pressure to get high end inflatable boats, rafts and reinforced backyard items nice and firm. You'll immediately notice how they perform better when properly inflated. A Pressure Release Valve is included to limit pressure to 1.4 psi for preventing over-inflating towables, pool toys and other vinyl and nylon covered inflatable items. The accordion-style hose locks onto the pump, eliminating annoying disconnection. Four universal valve fittings fit all popular valves and lock onto the hose. You'll love the screw-on Boston Valve adapter, an AIRHEAD exclusive. For added convenience, there's a carry handle and a 10 ft. long power cord. Draws 6.1 amps / 730 watts. Volume is 460 liters/minute.



Description	Part No.
Airhead Air Pump, 12 V	AHP-120HP

AIRHEAD® AIR PUMP, 12V

This high-volume (290 liters / minute) 12-volt portable air pump deflates towables, boats, pools, mattresses and beach toys quickly and effectively. Most pumps on the market, even those costing twice as much, don't put out this kind of air pressure and volume (9.6 cu.ft./min., .8 psi). The universal valve fittings fit all popular valves. For added convenience, the cigarette lighter plug is equipped with a 10 ft. long power cord.



Description	Part No.
Airhead Air Pump, 12 V	AHP-12H

AIRHEAD® DOUBLE ACTION PUMP

Perfect For Topping off Towables

This pump delivers a continuous stream of air on both the up and down strokes. It quickly inflates and deflates tubes, airbeds, boats, toys and other inflatables. Four universal valve fittings are included. The accordion-style hose stretches to 5 ft. long and interlocks to the pump, so that it doesn't fall off while you're pumping. Capacity is approximately 68 gallons / 60 strokes. Especially great for topping off towables, since peak pressure is 14 psi.



Description	Part No.
Airhead Double Action Pump	AHP-1

AIR DADDY™

AIR DADDY lets you get to the fun times more quickly! It allows you to inflate towables, swim toys, beach toys, inflatable boats, rafts, airbeds and sport balls with an air compressor at home or at a gas station. AIR DADDY is a universal adapter tapered to fit all valves found on inflatables, including all sizes of stem valves and Boston valves, Halkey-Roberts and Leaffield valves. The screw-on tip creates a high-pressure stream of air, perfect for workshops and garages. Soccer ball or football low on air? Stop by a gas station and use AIR DADDY's needle valve! Both the needle valve and high-pressure tip stow securely in the handle.



Description	Part No.
Air Daddy	AHAD-1



MULTI-VALVE

Inflate with Speed & Flexibility

The Airhead Multi-Valve consists of 2 Boston Valves with different thread patterns on the bottom of the Shrader Valve. One of the Boston Valves will fit your inflatable. Use the Shrader Valve to inflate quickly at a gas station or marina. Or, screw off the Shrader Valve and inflate the Boston Valve with a low pressure/high volume pump.

Description	Part No.
Multi-Valve	AHMOV-1

FOUR STROKE
 INTAKE SYSTEMS
 ENGINE/GASKETS
 EXHAUST
 DRIVE LINE HANDLING
 ELECTRICAL
 WATERLINE /BILGE
 STEERING & CONTROLS
 BODY
 SERVICE TOOLS ACCESSORIES /HARDWARE
 CHEMICAL



PRO MODEL RESCUE SLED

US Utility Patent 5,354,222 and other patents pending.

Used by top watermen and Rescue Professionals for over 20 years!



- Length: 63 inches (160cm) and 67 inches (170cm) with optional bumpers.
- Width: 37.50 inches +/- 0.50 inches (95.25cm +/-1.27cm)
- Thickness: 3.85 in. (10cm) at thickest point.
- Capacity: 397 lbs.(180 kg) or two adults.
- Weight: is approximately 42 lbs (19 kg) - sled dry weight, includes molded plastic hull and deck pad.

Recommended for three-seat pwc's for all types of waterborne rescue operations or recreational activities, including tow-in surfing and spear fishing. This model has been the standard for rescue operations around the world.



Tapered Tail

- The tail is tapered at 2.5 inches thick (6.75cm) so that the sled will not have too much flotation, and will sink a few inches under the water while the pwc is at idle. This feature in the Pro Model Sled allows rescue swimmers to easily place hypothermic or



unconscious victims upon the sled deck from the water level without having to lift the victim up as one would have to do with a sled that has too much buoyancy. The Pro Sled tail lifts back up on top of the water surface and planes efficiently while the PWC is moving forward.

- 8 Handgrips made from 5000lb test nylon webbing, overmolded with proprietary, flexible elastomers, very durable and resistant to the elements. Handgrips are anchored to the sled hull using 7000lb test brass mold-in inserts and stainless fasteners. Fasteners are secured from backing out using Lock-tite.

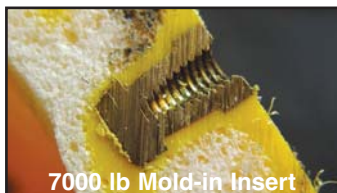

7000 lb Mold-in Insert

- Vibration Issues - The PRO Extraction Sled utilizes flexible linear low density polyethylene, flexible urethanes or EVA copolymers as bumpers at the connecting points, and a cushioning deck pad. All of these items have been used to reduce vibration caused from pwc motors. The Pro Sled, being a molded sled, transfers no more insignificant vibration than any other sled on the market.

- 3/8" thick PVC Foam Deck Pad - Very Comfortable. Durable and provides the right amount of traction. Non-slippery like the polyethylene bodyboard foams or non textured PVC foams.

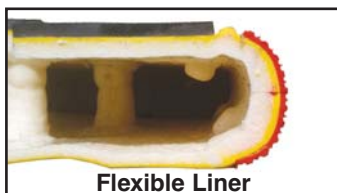

Flexible Liner

- Basic Tie Down Version with nylon webbing/bungee cords/bumper. Utilizes universal convenient 3-point hook-up to all makes and models of pwc. The attachments are non-invasive as they are already molded into the sled as holes for rigging.

- Nylon webbing and stainless spring clips are used and attached to the center main holes in the sled for the center attachment point to the pwc, bungee cords and stainless spring clips are attached to the outboard holes for rigging.

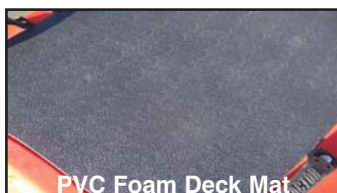

PVC Foam Deck Mat

- U-bolts to be installed on pwc hull for mounting sled to the pwc are included (all pwc's require at least one, and up to three of the U-bolts installed on all tie down sleds for a proper 3-point hookup (depending on pwc model). Nose of sled is protected by the use of a replaceable bumper.

**Hand Grip Color: Black is standard. Red or Yellow are optional.
 Hull Color: Orange is standard. Red, Yellow, Military Green, Battleship Grey or Black are optional.**



Tie Down Version

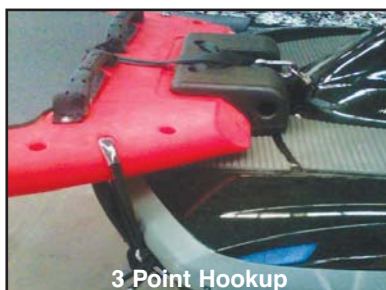

3 Point Hookup

Description	Part No.
Pro Model Rescue Sled 3 Point Tie Down Version	XPROTD

***We do not stock inventory of these items
 -special order only.***



LIFESLED FOR PWC RESCUE

Lifeguards and public safety agencies around the world are embracing an innovative rescue system that already has saved hundreds of lives, and promises to save thousands more in extreme rough water situations such as ocean storms, heavy surf, rip currents, flooding rivers and other life-threatening situations.

Non-Invasive hookup conveniently attaches LIFESLED to most any PWC without cumbersome rigging or drilling holes.

- ◆ LIFESLED is highly maneuverable. It barely affects low-speed motoring and increases the overall stability of the craft. There is no chance of windmilling or dumping of victim.
- ◆ Bullet-nose allows 45° fish-tail pivot off the PWC transom.
- ◆ 70/30 rails allow sufficient tracking for stability, and still allow the driver to 'break loose' for quick turns.
- ◆ Inexpensive, replaceable nose-guard protects the nose of the sled and the PWC transom.
- ◆ Overall size is sufficient for two adults yet still highly maneuverable. Weighs only 35 lbs.
- ◆ The Swallow-tail design enables easy victim centering when mounting in the water.
- ◆ Hook-up design allows the sled to be folded over the PWC when not in use.



Description

Lifesled

Part No.

W20018

We do not stock inventory of these items—special order only.



HONDA

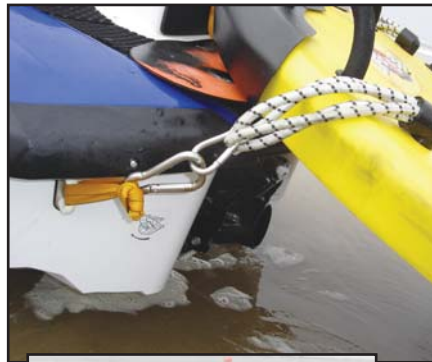

YAMAHA



SEA-DOO



STAINLESS STEEL UNIVERSAL SNAP HOOK

Length	Ring Diameter	Maximum Safe Load	Part No.
4"	3/8"	1,000Lbs.	AW12417L3
4-3/4"	7/18"	1,250Lbs.	AW12419L3

FOUR
STROKE

INTAKE
SYSTEMS

ENGINE/
GASKETS

EXHAUST

DRIVE LINE
HANDLING

ELECTRICAL

WATERLINE
/BILGE

STEERING
& CONTROLS

BODY

ACCESSORIES
SERVICE TOOLS

/HARDWARE

CHEMICAL

FACTORY ZERO

FACTORY ZERO JET LAUNCHER COMPACT 2-WHEEL TOTE FOR STAND-UP PWC



World Class Free Rider Taylor Curtis said:
 "The Factory Zero Jet Launcher is so nice to use! It rolls across soft sand with ease, making it possible to launch by yourself. They are very well made, everything fits perfectly when assembling. It comes apart just as easy for traveling or storing. To top it off they look killer. I have had many kinds of totes over a 20 year riding career and Factory Zero tops them all! Thank you for making such an awesome product."



Description
 Factory Zero Compact 2-Wheel Tote Stand-Up
 Due to the size of this product it is not covered by the Hot Products shipping policy.

Part No.
J-130S

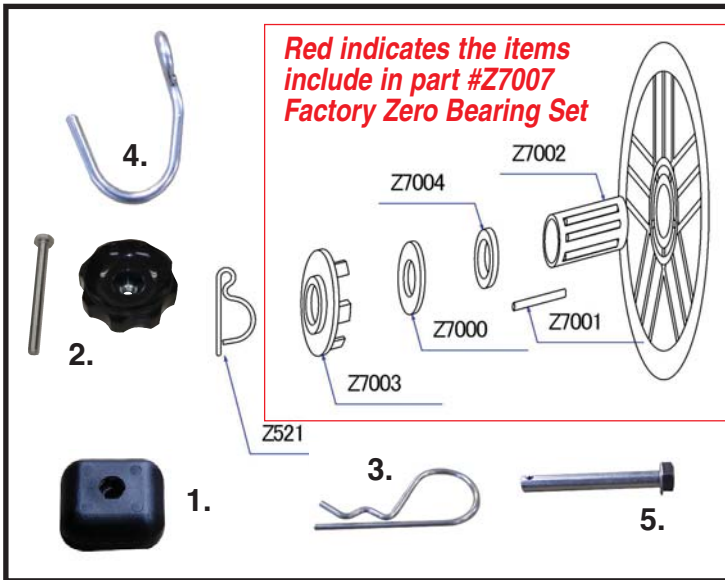

JET LAUNCHER (J-130S) REPAIR PARTS

Factory Zero offers the highest quality Jet Launchers for your Stand-up PWC and has repair/replacement parts available to allow you to utilize your Jet Launcher for many years to come.

Description	Part No.
Composite Fiber Washer	Z7000
Needle Only (10 needles)	Z7001
Bearing Cage Only	Z7002
Nylon Cap for Wheel	Z7003
Nylon Washer	Z7004
"D" Lock Ring for Tire	Z521
Bearing Complete Set	Z7007
1. Plastic Receiver for Tote Handle Connection	Z6037
2. Plastic Knob for Tote Handle Connection	JS220
3. "R" Lock Pin For Legs	P13-130
4. Stainless Hook	JL100
5. Pin for Legs	P17-16
Rail End Cap	Z6028-1



FACTORY ZERO ATV HITCH BRACKET FOR J-130S

Description
 ATV Hitch Bracket for J-130S
 *Due to the size of this product it is not covered by the Hot Products shipping policy.

Part No.
JL258

Description
 4-Wheel Tote 3 Seat PWC
 *Due to the size of this product it is not covered by the Hot Products shipping policy.

Part No.
J-1480-4

FACTORY ZERO

Are you ready to go fishing in style? FACTORY ZERO STAINLESS STEEL PWC FISHING RACK

The Factory Zero PWC Fishing Rack is made from high grade polished stainless steel material for strength, durability and to Factory Zero's high quality standards. These units have been developed and tested to allow the best and safest fishing experience available aboard a PWC.

Installation and removal is fast and easy and **requires no drilling**. The front of the fishing rack mounts securely to the rear tow hook OEM holes by simply following the instructions and utilizing the supplied hardware. The rear of the fishing rack utilizes the Factory Zero ratchet strap system to attach the rear OEM tie down hooks.

The rack is designed with drain holes to allow any water that might get in the fishing rack to drain.

These units are made to fit each specific PWC model.

Included in the kit is one adjustable/positionable fishing rod holder and a soft sided cooler bag.



JL3500STX
STX 900/STX 110
STX-R/12F/15F



JL3500FX
FX 140/FX 160



JL3500VX
VX 110/VX Cruiser



JL3500ULT
Ultra 250 LX/Ultra 250X
Ultra 260 LX/Ultra 260X



JL3500GTX
GTX/RXT

Installation

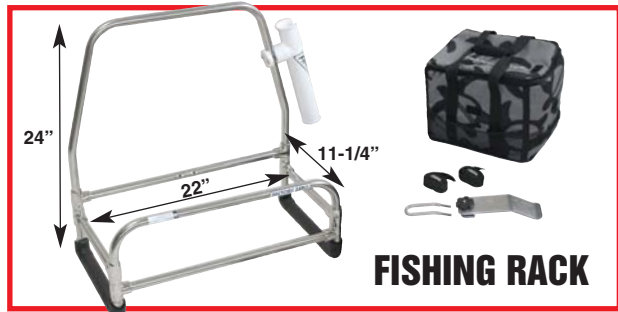

Kawasaki	Year	Fishing Rack Part No.
ULTRA 250X	2007-08	JL3500ULT
ULTRA 260X	2009-10	
ULTRA LX	2007-14	
ULTRA 260LX	2009-10	
ULTRA 300X	2011-13	
ULTRA 300LX	2011-13	
STX-12F	2003-07	JL3500STX
STX-15F	2004-14	

Yamaha	Year	Fishing Rack Part No.
FX Cruiser SHO	2012-14	JL3500FX2
FX SHO	2012-14	
FX Cruiser HO	2012-14	
FX HO	2012-14	
FX Cruiser SHO	2008-11	JL3500FX
FX SHO	2008-11	
FX Cruiser HO	2008-11	
FX HO	2008-11	
FX Cruiser	2008-11	
FX 140	2004	
VXR	2011-14	JL3500VX
VXS	2011-14	
VX Cruiser	2007-14	

Yamaha Continued	Year	Fishing Rack Part No.
VX Deluxe	2007-14	JL3500VX
VX Sport	2007-14	
VX110 Deluxe	2005-06	
VX 110 Sport	2005-06	

Sea-Doo	Year	Fishing Rack Part No.
GTX-4Tec	2004-07	JL3500GTX
GTX-4Tec SC	2004-05	
GTX-4Tec LTD SC	2004-05	
GTX-Limited	2006-08	
GTX 155	2008-14	
GTX 215	2009-13	
GTX LTD 215	2014	
RXT	2005-09	
RXT-X 255	2008-09	
RXT-X 260	2010	
RXT 260 RS	2011	
RXT-X aS 260 RS	2011	
GTI SE 155	2011-14	JL3500GTI
GTI 130 155	2011-14	
GTR 215	2012-14	

FOUR
STROKE

INTAKE
SYSTEMS

ENGINE/
GASKETS

EXHAUST

DRIVE LINE
HANDLING

ELECTRICAL

WATERLINE
/BILGE

STEERING
& CONTROLS

BODY

ACCESSORIES
/HARDWARE

SERVICE TOOLS

CHEMICAL

FACTORY ZERO

CLAMP ROD HOLDERS



Sea-Doo	Year	Clamp Rod Holder Part No.
GTX-4Tec	2004-07	JL3220B
GTX-4Tec SC	2004-05	
GTX-4Tec LTD SC	2004-05	
GTX-Limited	2006-08	
GTX 155	2008-14	
GTX 215	2009-13	
GTX LTD 215	2014	
RXT	2005-09	
RXT-X 255	2008-09	
RXT-X 260	2010	
RXT-X RS	2011	
RXT-X aS 260 RS	2011	
GTI SE 155	2011-14	JL3220B
GTI 130 155	2011-14	
GTR 215	2012-14	

Kawasaki	Year	Clamp Rod Holder Part No.
ULTRA 250X	2007-08	JL3220ULT
ULTRA 260X	2009-10	
ULTRA LX	2007-14	
ULTRA 260LX	2009-10	
ULTRA 300X	2011-13	
ULTRA 300LX	2011-13	

Yamaha	Year	Clamp Rod Holder Part No.
FX Cruiser SHO	2012-14	JL3220FX-B
FX SHO	2012-14	
FX Cruiser HO	2012-14	
FX HO	2012-14	
VXR	2011-14	JL3220VX-B
VXS	2011-14	
VX Cruiser	2007-14	
VX Deluxe	2007-14	JL3220VX-B
VX Sport	2007-14	
VX110 Deluxe	2005-06	
VX 110 Sport	2005-06	



FACTORY ZERO SERVICE STAND

Description	Part No.
Factory Zero Service Stand for Stand-Up Ski	J-203S



RIVA DAVIT SLINGS

RIVA Davit Slings feature high strength nylon straps and stainless steel lift ring. Easily attaches to your watercraft via non-slip, non-scratch, rubber coated plates that securely lift the craft under the rub rails. Designed to use with a single davit.

Description	Part No.
Lifting Sling, KAW, SD 3-seater PWC GTX, RXP, RXT	RS1027-IS
Lifting Sling, 2-seater PWC	RY1027
Lifting Sling, SUV, XL, VNT	RY1027-20

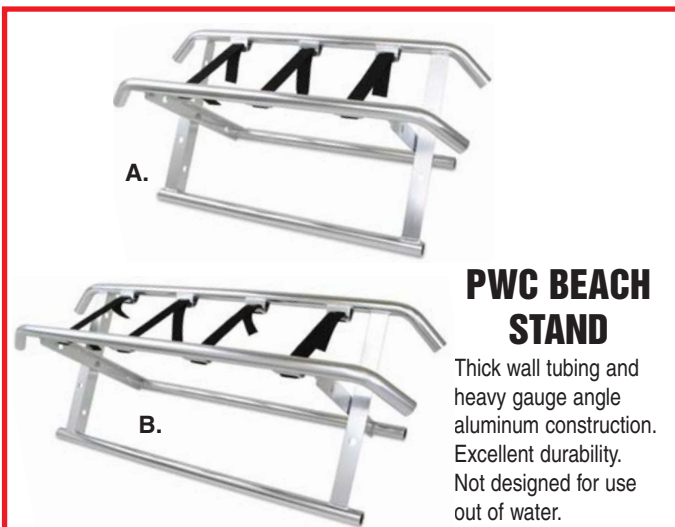

PWC BEACH STAND

Thick wall tubing and heavy gauge angle aluminum construction. Excellent durability. Not designed for use out of water.

Description	Part No.
A. Stand-Up Personal Watercraft Beach Stand	62-791001
B. Sit Down Personal Watercraft Beach Stand	62-792001

Due to the size of this product it is not covered by the Hot Products shipping policy.



WSM PWC SLING

Description	Part No.
WSM PWC Sling (1,000 lbs. capacity)	011-1001

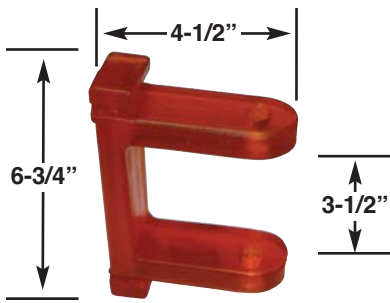

STOLTZ BOW STOP

For PWCs with a vertical hole. Fastens with "U" bolts. 3-1/2" Opening. Made in the USA.

Description	Part No.
PWC Bow Stop	PWC-5A



HITCH PIN FOR BOW STOP

Description	Part No.
Hitch Pin 5/8" x 6-1/4" Pin with 8" Lanyard for Cotter Pin.	59-3460



SKEEKEEPER HITCH PIN

Fits any receiver-style hitch with a 2" insert. Trailer hitch receiver and ball pictured is not included.

Description	Part No.
Hitch Pin	TS68



LICENSE PLATE BRACKET

1/4" mounting holes on 2" centers.

Description	Part No.
Metal License Plate Bracket	WB-3213



RV TRAILER WIRING SOCKET ADAPTER

This adapter converts the large 7 prong RV style wiring plug to the standard universal flat 4 way trailer wiring. No cutting or splicing required.

Description	Part No.
RV Trailer Wiring Adapter	73012



037-0260



037-2060

ADRAN TIE DOWNS

Adran tie downs are produced with the highest quality materials, straps and hardware strong enough for the toughest jobs. These tie downs feature a 1" wide tie down material that has a 4,500 lb rating, the S-hook is rated for 2,500 lbs and the carabiner is rated for 1,600 lbs. Manufactured in the USA and built to last.

Description	Part No.
7' Black with 2 Floating Coated Center S-Hooks and 2 Carabiners	037-0260
5' Black with 2 Coated S-Hooks, 1 Floating Center Coated S-Hook, and (2) 11" Soft Hook Straps with loops at each end, this is the ultimate universal tie down.	037-2060



R&D EZ-SLIDE BUNK GLIDES

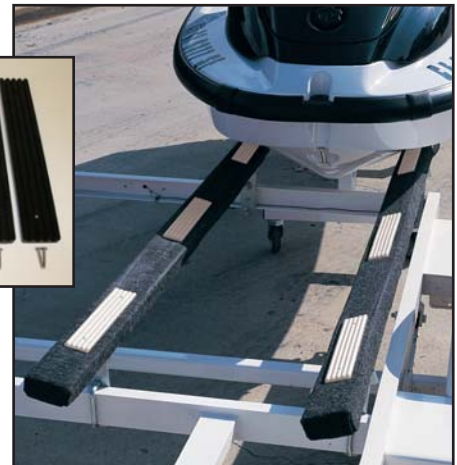

R&D EZ-Slide Bunk Glides are designed to mount directly on the top side of the trailer bunks creating a new low friction slippery surface that allows the watercraft to glide on or off the trailer, making loading and unloading a personal watercraft easy. Designed and molded from high density urethane to significantly support the hull surface for proper trailering. The EZ-Slides are black and come in a six piece set complete with stainless steel button head mounting hardware. One set needed per watercraft.

Description	Part No.
EZ-Slide Bunk Glides (Set of 6)	001-00122



Scan to see video

AQUASOCKS ULTIMATE FUEL TANK WATER REMOVER

Do you have water in your fuel? AquaSocks will easily and safely remove water from fuel tanks (gasoline, diesel fuel and motor oil) without you having to drain the fuel or oil first. We use a chemical that turns water into a hard, gelatinous mass that is sewn into a porous sleeve of our AquaSocks material. Simply drop the AquaSock into your fuel tank, let it soak for 24 hours and when

it's extracted the water is gone and the gel stays in the sock. Can pull out up to 12 oz. of water from your fuel tank and will fit in an access hole of no smaller than 1-3/8" in diameter.

Description	Part No.
AquaSocks	AQ12



HUNSAKER QUICK FILL JUGS

MADE IN THE U.S.A.

- Quick Fill jugs feature a 2 1/4" quick fill opening/fill tube
- The 1 1/2" side vent tube works as an air intake and relieves back pressure, allowing for a controlled flow rate and is adjustable for your flow rate application
- Secondary flip up vent cap for a slower pour if required
- Can be filled from the vent tube side and/or the pour side without having to take the hose off
- Smooth cornered, square style design offers stability, strength and ease of handling

Description	Part No.
A. 5 Gallon Jug (12"x12"x24")*	HUN3004-1
B. 11 Gallon Jug (12"x12"x36")*	HUN3011-1
C. 1.50" Billet 6061/Aluminum Quick Fill Fueling System	HUN3113
D. 2.50" (Male) Red Head Dry Break	HUN3115
E. 2.50" (Female) Dry Break	HUN3123

*Supplied with hose and clamps for connection

Due to the size of this product it is not covered by the Hot Products shipping policy

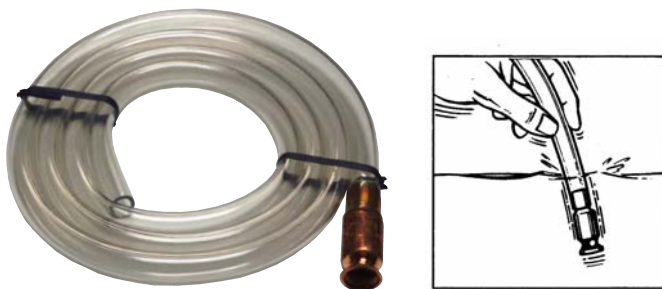

SAFETY SIPHON

"The Safe Solution To Fluid Transfer Problems".

A safe alternative to transferring dangerous fuels at or messy liquids by usual means. The hose with the patented self priming pump eliminates the risk of drawing hazardous or nasty fluids into your mouth when getting the siphon process started. The Safety Siphon is a great companion product to carry in your car or truck as insurance in case you run out of gasoline.

Never attempt to siphon gasoline by mouth!

Description	Part No.
Safety Siphon Pump 1/2"ID Hose, 6' Length	MW05003



RATIO RITE CUP & LID

The Ratio Rite measuring cup is specifically designed to help you premix gasoline for your

two stroke engine. 16:1 to 70:1 mix ratios are molded into this cup, measure your two cycle oil in cc/milliliters, fluid ounces, and pints. Made from durable, long lasting plastic that is completely safe to use with fuel and oil.

*Ratio Rite lid sold separately

Description	Part No.
Ratio Rite Cup	59-0548
Ratio Rite Lid	59-0582

HOT PRODUCTS DIE CUT DECALS



HOT PRODUCTS CORPORATE LOGO

Length	Color	Part No.
10.5" Length	Black	HOTPRODUCTS10.5-BLK
10.5" Length	Chrome	HOTPRODUCTS10.5-CHROME
10.5" Length	White	HOTPRODUCTS10.5-WHT
16" Length	Black	HOTPRODUCTS16-BLK
16" Length	White	HOTPRODUCTS16-WHT



HOT PRODUCTS TUBE LOGO

Length	Color	Part No.
12" Length	Black	HP-TUBE-BLK-12
12" Length	Chrome	HP-TUBE-CHROME-12
12" Length	White	HP-TUBE-WHT-12
30" Length	Black	HP-TUBE-BLK-30
30" Length	Chrome	HP-TUBE-CHROME-30
30" Length	White	HP-TUBE-WHT-30

HOT PRODUCTS RACING OUTDOOR/EVENT BANNER



Hot Products Racing Banner. 10' wide by 3' tall. Outdoor vinyl with grommets to hang the Banner up. The Banner is blue with white lettering.

Description	Part No.
Hot Product Racing Banner 10' x 3'	BANNER-BLU
Hot Product Racing Banner Small 36" x 12"	BANNER-S-BLU



HOT PRODUCTS RACING LOGO

Length	Color	Part No.
10.5" Length	Black	HOTRACING10.5-BLK
10.5" Length	Chrome	HOTRACING10.5-CHROME
10.5" Length	White	HOTRACING10.5-WHT
16" Length	Black	HOTRACING16-BLK
16" Length	White	HOTRACING16-WHT



HOT PRODUCTS DECAL SHEET

This sheet of Hot Products Decals has a total of 16 die cut stickers ready to peel off and install on your PWC.

Description	Part No.
Hot Products Decal Sheet 8" x 12 1/2"	70-9148



HOT PRODUCTS RACING IRON-ON TRANSFER

Hot Products Racing Iron-on logo. Create your own custom apparel with this easy to use iron-on logo. Available in white and the logo is 7 1/2" wide by 2" tall.

Description	Part No.
Iron-on Transfer	LOGO-TRANSFER



2015 IJSBA QUAKYSENSE WORLD FINALS IN LAKE HAVASU CITY, ARIZONA. PHOTO COURTESY OF JIN OMURA.

FOUR
STROKE

INTAKE
SYSTEMS

ENGINE/
GASKETS

EXHAUST

DRIVE LINE
HANDLING

ELECTRICAL

WATERLINE
/BILGE

STEERING
& CONTROLS

BODY

ACCESSORIES
SERVICE TOOLS
/HARDWARE

CHEMICAL

FOUR STROKE
INTAKE SYSTEMS
ENGINE/GASKETS
EXHAUST
DRIVE LINE HANDLING
ELECTRICAL
WATERLINE /BILGE
STEERING & CONTROLS
BODY
SERVICE TOOLS ACCESSORIES /HARDWARE
CHEMICAL



HOT PRODUCTS LIMITED EDITION MENS T-SHIRT

Description	Part No.
Small	70-8003-S
Medium	70-8003-M
Large	70-8003-L
X-Large	70-8003-XL

HOT PRODUCTS LIMITED EDITION WOMENS T-SHIRT

Description	Part No.
Small	70-8004-S
Medium	70-8004-M
Large	70-8004-L

DVD



2004 LENZI DVD
70-0020

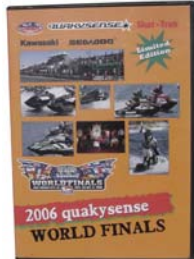

2006 WORLD FINALS
WFDVD2006

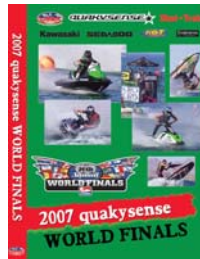

2007 WORLD FINALS
WFDVD2007



TWANGULATION DVD
70-0022

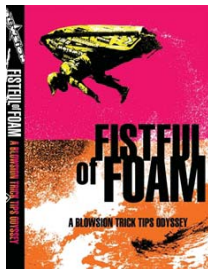

FISTFUL OF FOAM
BLOWSION TRICK TIPS ODYSSEY
07-02-267

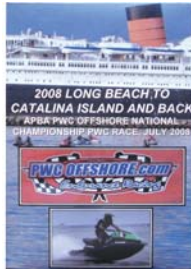

2008 LONG BEACH TO CATALINA DVD
OFFSH002



2009 LONG BEACH TO CATALINA DVD
LB2CAT009



AZ-18 AQUA ZOOKA™

Soak your friends with AQUA ZOOKA! This easy to operate, quick filling bazooka is constructed of high-impact thermoplastics and will last for seasons of fun. Simply dip AQUA ZOOKA into the water and pull back on the handle to siphon water up into the barrel. You're ready to fire, with a range of up to 60 feet! AQUA ZOOKA's are equipped with comfortable EVA handles so that you won't lose your grip, even with wet hands in the heat of battle! The EVA handles also ensure that AQUA ZOOKA will float on top of the water. Doubles as a bilge pump!

Description	Part No.
AQUA ZOOKA 18"	AZ-18



YAMAHA

Yamaha Water Vehicles 1993-1996

WR500, SJ650, WR650,
WRA650, WRA650A,
WRB650, WRB650A, FX700,
SJ700, RA700, RA700A,
RA700B, WB700A, WRA700,
WRB700, WVT700, RA760,
WB760, RA1100, WVT100

Part No. W806

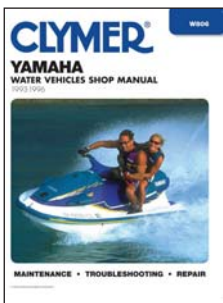

Yamaha Water Vehicles 1987-1992

WJ500, WRA650, WR500,
SJ650, WR650

Part No. W805

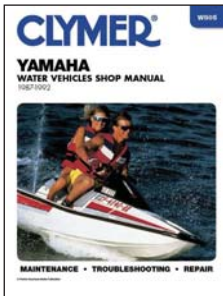

Yamaha Water Vehicles Four Stroke 2002-2009*

05-08 FX, 05-08 FX Cruiser,
04-08 FX Cruiser High Output,
04-08 FX High Output,
02-04 FX140,
02-04 FX140 Cruiser,
05-09 VX,
05-09 VX Cruiser,
05-09 VX Deluxe,
05-09 VX Sport

Part No. W807

*Includes color wiring diagrams.
Does not cover 1800 cc models.
Does not cover 2-stroke models.*

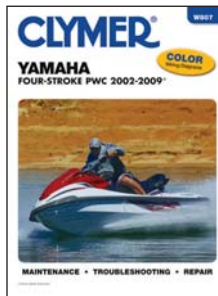

SUPER BN MANUAL

For the watercraft tuner working with Super BN series carburetors.

Description Part No.
Mikuni Manual 53-9999

KAWASAKI

Kawasaki Jet Ski 1976-1991

JS300, JS550, JS300SX,
JS550SX, JS400, JF650X-2,
JS440, JS650SX, JF650TS,
JL650SC, JB650TS Jet Mate

Part No. W801

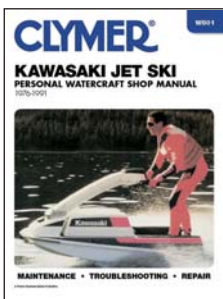

Kawasaki Jet Ski 1992-1994

JS440, JS550, JS550SX,
JB650 Jet Mate, JF650X-2,
JF650TS, JL650SC,
JS650SX, JH750SS,
JS750SX, JH750Xi,
JT750ST, JH750XIR

Part No. W802



THE "ORIGINAL" JET SKI BIBLE

A straight forward high performance guide for the Kawasaki 440, 550, 650. The Watcon 2-stroke tech manual is also included.

This is a *MUST* have book for building, maintaining, or owning a high performance personal watercraft. This manual features David Simon's "The Understanding of Air Flow." It goes into structural limitations and factors, crank case design, crank shaft design, cylinder and port design, cylinder head design, exhaust systems and water box design, intake systems, and tuning an engine as a whole.

Two great books for the price of one!

Description Part No.
Jet Ski Bible & JSB-02
Watcon 2-Stroke
Technology Notes

SEA-DOO

Sea-Doo Water Vehicles 1988-1996

Standard GT, GTS, GTX,
SP, SPi, XP

Part No. W809-3



Sea-Doo Water Vehicles 1997-2001

GS/GSI/GSX/GSX RFI/
GSX Ltd./GTI/GTS/GTX
GTX DI/GTX RFI/GTX Ltd.
HX/LRV/RX/RX DI
SP/SPX/XP Ltd.

Part No. W810



POLARIS

Polaris Water Vehicles 1993-1995

SL650, SL650STD,
SL750, SLT750

Part No. W819

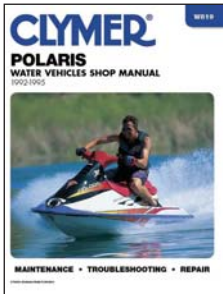

Polaris Water Vehicles 1996-1999

SL700, SLT700,
SL700 Deluxe, Hurricane,
SL780, SLT780, SL900,
SL1050, SLH, SLTH,
SLXN, SLTX

Part No. W820

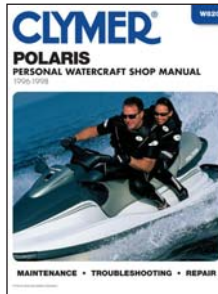

FOUR STROKE
 INTAKE SYSTEMS
 ENGINE/GASKETS
 EXHAUST
 DRIVE LINE HANDLING
 ELECTRICAL
 WATERLINE /BILGE
 STEERING & CONTROLS
 BODY
 SERVICE TOOLS ACCESSORIES
 CHEMICAL /HARDWARE

METRIC STAINLESS STEEL HEX BOLT PACKS

10 Pieces Per Package



Size/mm	Part No.
6 x 10	60-3010
6 x 12	60-3012
6 x 14	60-3014
6 x 16	60-3016
6 x 18	60-3018
6 x 20	60-3020
6 x 25	60-3025
6 x 30	60-3030
6 x 35	60-3035

Size/mm	Part No.
6 x 40	60-3040
6 x 45	60-3045
6 x 50	60-3050
6 x 60	60-3060
6 x 70	60-3070
6 x 80	60-3080
8 x 18	60-4018
8 x 20	60-4020

Size/mm	Part No.
8 x 25	60-4025
8 x 30	60-4030
8 x 35	60-4035
8 x 40	60-4040
8 x 50	60-4050
8 x 60	60-4060
8 x 80	60-4080
10 x 25	60-5025

METRIC STAINLESS STEEL SOCKET HEAD CUP BOLT PACKS

10 Pieces Per Package



Size/mm	Part No.
4 x 30	61-1030
4 x 16	61-1016
5 x 10	61-2010
5 x 25	61-2025
6 x 10	61-3010
6 x 12	61-3012
6 x 14	61-3014

Size/mm	Part No.
6 x 16	61-3016
6 x 20	61-3020
6 x 25	61-3025
6 x 30	61-3030
6 x 35	61-3035
6 x 40	61-3040
6 x 50	61-3050

Size/mm	Part No.
6 x 60	61-3060
8 x 20	61-4020
8 x 25	61-4025
8 x 30	61-4030
8 x 50	61-4050
8 x 60	61-4060
10 x 25	61-5025

METRIC STAINLESS STEEL NUTS

10 Pieces Per Package



Size	Part No.
6mm	63-0006
8mm	63-0008

METRIC STAINLESS STUD PACKS

Size/mm	Part No.
8 x 30	62-4030
10 Pieces Per Package	
6 x 25	62-3025
Sold Individually	



METRIC STAINLESS STEEL FLAT WASHERS

10 Pieces Per Package



Size	Part No.
6mm	63-2006
8mm	63-2008
10mm	63-2010

METRIC STAINLESS STEEL SPRING WASHERS

10 Pieces Per Package



Size	Part No.
6mm	63-4006
8mm	63-4008
10mm	63-4010

ZIP TIES



Description	Color	Part No.
3 3/4" x .090	Black	64-0050
7 1/4" x 1.190	Black	64-0051

(Sold in Packages of 100)

PLASTIC FITTINGS



Plastic T Fitting	Part No.
A. 3/8" x 3/8" x 3/8"	64-0025
B. 1/2" x 1/2" x 1/2"	64-0027
Plastic Y Fitting	Part No.
C. 3/8" x 3/8" x 3/8" (white)	64-0045
D. 1/4" x 1/4" x 1/4" (white)	64-0046
E. 1/4" x 1/4" x 1/4" (black)*	64-0047

*Reinforced with Crossbar

BRASS FITTINGS

MNPT = Male National Pipe Thread



Straight Hose Barbed	Part No.
1/8" MNPT Thread 1/4" Hose	64-0001
1/8" MNPT Thread 3/8" Hose	64-0003
1/4" MNPT Thread 1/2" Hose	64-0005



Barb Connector	Part No.
1/4" I.D. Hose to 1/4" I.D. Hose	64-0057
3/8" I.D. Hose to 3/8" I.D. Hose	64-0058
1/2" I.D. Hose to 1/2" I.D. Hose	64-0059



Brass Push in Nipple	Part No.
1/8" Straight	53-9936
1/4" Straight	53-9937

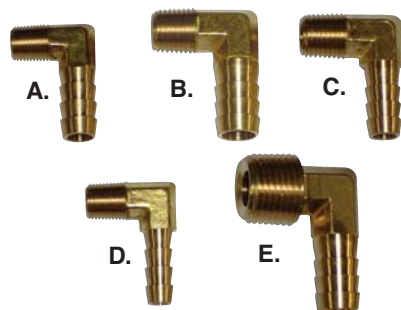

90 Degree	Part No.
A. 1/8" MNPT Pipe thread 3/8" Hose Barb	64-0007
B. 1/4" MNPT Pipe thread 1/2" Hose Barb	64-0009
C. 1/4" MNPT Pipe thread 3/8" Hose Barb	64-0006
D. 1/8" MNPT Pipe thread 1/4" Hose Barb	64-0010
E. 1/2" MNPT Pipe thread 1/2" Hose Barb	64-0008



This brass hose adapter is supplied with a flat rubber washer/seal for the garden hose to adapter seal that prevents water from spraying when connected and under pressure.

Garden Hose Adapter	Part No.
3/8" Hose Barb to Standard Garden Hose	64-0012



Press-in 90 Degree Fuel Inlet	Part No.
1/4" Hose 90 Degree	DF44-2/70



45 Degree	Part No.
1/8" MNPT Pipe thread 1/4" Hose Barb	64-0065
1/8" MNPT Pipe thread 3/8" Hose Barb	64-0066
1/4" MNPT Pipe thread 1/2" Hose Barb	64-0067

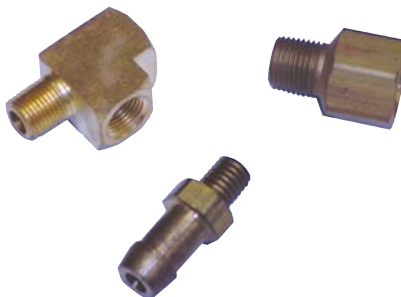

Brass Fitting	Part No.
1/8" Pipe threaded junction	64-0011
1/8" to 1/4" Adapter	64-0013
9mm Yamaha Flush Adapter	64-0004



Brass T-Fitting	Part No.
Primer Fitting 1/8" x 1/8" x 1/8"	64-0015
Primer 1/4" x 1/4" x 1/8"	64-0017
Fuel Line 1/4" x 1/4" x 1/4"	64-0019



Brass Threaded Plug	Part No.
1/8" MNPT Threaded Plug	64-0016
1/4" MNPT Threaded Plug	64-0018

FOUR STROKE
INTAKE SYSTEMS
ENGINE/GASKETS
EXHAUST
DRIVE LINE HANDLING
ELECTRICAL
WATERLINE /BILGE
STEERING & CONTROLS
BODY
ACCESSORIES
SERVICE TOOLS
HARDWARE
CHEMICAL

FOUR
STROKEINTAKE
SYSTEMSENGINE/
GASKETS

EXHAUST

DRIVE LINE
HANDLING

ELECTRICAL

WATERLINE
/BILGESTEERING
& CONTROLS

BODY

SERVICE TOOLS
ACCESSORIES

/HARDWARE

CHEMICAL

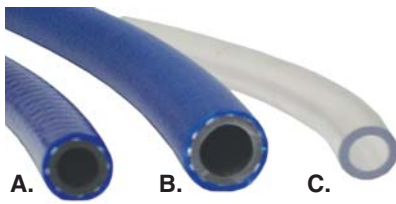

WATER LINE HOSE

Description	Part No.
A. 3/8" ID Blue 300psi WP (Eaton Synflex)	56-8000
3/8" ID Blue 300psi WP (Goodyear Pliovic Plus)	56-8015
B. 1/2" ID Blue 250psi WP (Goodyear Pliovic Plus)	56-8004
C. 3/8" Clear Vinyl	56-8007

500 foot reel 3/8" blue hose available and
400 foot reel 1/2" blue hose available
Call for special pricing on reel purchases.



WATER LINE SILICONE TUBING

Description	Part No.
3/8" ID Blue (Venair Technosil) Silicone Tubing (Sold in 25 foot lengths)	56-8012-25



HELIX HIGH PRESSURE TUBING

Helix High Pressure Tubing is a premium polyurethane, 85 durometer, which provides for superior abrasion, kink, tear, oxidation and chemical resistance. This tubing is very strong with a nylon inner band yet stays flexible. 3/8" ID x 9/16" OD Polyurethane, Nylon Interbraid Color Match Water Line

Description	Part No.
25 Foot HP Red Water Line	380-9175
25 Foot HP Yellow Water Line	380-9176
25 Foot HP Blue Water Line	380-9177
25 Foot HP Green Water Line	380-9178
25 Foot HP Clear Water Line	380-9179



STAINLESS STEEL HOSE CLAMPS

SAE Size	Min Dia		Max Dia		Part No.
	Inch	mm	Inch	mm	
#4 (Fuel & 3/8" Waterline)	1/4"	6	5/8"	16	6260451*
#5 (3/8" and 1/2" Waterline)	1/4"	7	3/4"	19	62M0551
#6 (3/8" and 1/2" Waterline)	5/16"	8	7/8"	22	6260651
#10 (3/4" Bilge Hose)	1/2"	13	1-1/16"	27	62M10
#16 (1-1/8" Bilge Hose)	5/16"	8	1-1/2"	38	62M16
#36	1-3/4"	46	2-3/4"	70	WF67004-0036
#48	2-1/2"	65	3-1/2"	89	WF67004-0048
#56	2-1/8"	54	4"	100	WF67004-0056
#72	3"	76	5"	127	WF67004-0072
#80	3-1/2"	92	5-1/2"	140	WF67004-0080

*The new #4 clamp is perfect for 3/8" waterline, when the clamp is tight there is a very short tail to create a very clean installation and prevent snagging your hand when working in the engine compartment.



T-BOLT CLAMPS

Size	Minimum Diameter		Max Diameter		Part No.
	Inch	mm	Inch	mm	
#238	2 15/64"	56.7531	2 29/64"	62.3094	D43H-75-238
#300	2 12/16"	70.2564	3 1/16"	77.7748	D40H-75-300
#325	3 5/32"	80.1687	3 21/64"	84.5344	D40H-75-325
#400	3 49/64"	95.6469	4 1/6"	105.833	D40H-75-400
#450	4 17/64"	108.347	4 9/16"	115.887	D40H-75-450
#500	4 49/64"	115.887	5 1/16"	128.587	D40H-75-500
#525	5 11/64"	131.366	5 5/16"	134.937	D40H-75-525
#550	5 17/64"	133.747	5 9/16"	141.287	D40H-75-550

All T-Bolt Clamps are 3/4" (.75mm) wide



Fast, Easy, Strong and Secure Installation



SQUEEZE ON STAINLESS STEEL LOW PROFILE CLAMPS

See page 125 for more information



HOT PRODUCTS 1/4" FUEL LINE & 1/8" PRIMER LINE

Our fuel and primer line is made from a thick walled polyurethane tubing. Both the fuel and primer line are translucent lines. Sold per foot or 25 feet packages.

Description	Size (ID)	Length	Part No.
Blue Fuel Line	1/4" - Fuel	Per foot	53-9970
Blue Fuel Line	1/4" - Fuel	25 feet	53-9970-25
Red Fuel Line	1/4" - Fuel	Per foot	53-9972
Red Fuel Line	1/4" - Fuel	25 feet	53-9972-25
Green Fuel Line	1/4" - Fuel	Per foot	53-9974
Green Fuel Line	1/4" - Fuel	25 feet	53-9974-25
Blue Primer Line	1/8" - Primer	Per foot	53-9980
Blue Primer Line	1/8" - Primer	25 feet	53-9980-25

*Call for special pricing on full roles of these lines.

SEA-DOO REPAIR TOOLS

These tools are built to the OEM specialty tool specifications and have been built using high quality materials.

Make your work day and the repairs you perform for your customers faster and more efficient with the right tool for the job!

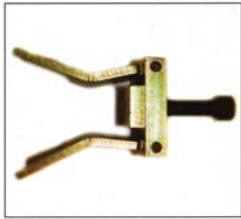

Drive Shaft / Floating Ring
Part No. 950-100
O.E. No. 529-035-841
Fits: GTX 4 Tec Models

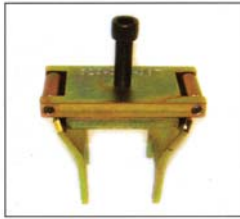

Drive Shaft / Floating Ring
Part No. 950-102
O.E. No. 529-035-987
Fits: Super Charged 4-Tecs

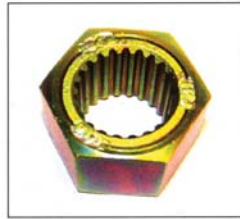

Drive Shaft Adaptor
Part No. 950-115
O.E. No. 529-035-892
Fits: GTX 4 Tec

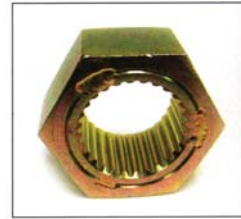

Drive Shaft Adaptor
Part No. 950-120
O.E. No. 529-035-985
Fits: RXP 4 Tec



Terx Adaptor for all Supercharged 4-Tec
Part No. 950-185
O.E. No. 529-035-938
Fits: 4-Tec Supercharger



Insert Alignment Tool Adapter
Part No. 950-145
O.E. No. 529-035-590
Fits: XP & DI Models



Alignment Adaptor
Part No. 950-150
O.E. No. 529-035-719
Fits: GTX 4-Tec Models



Super Charger Retaining Key
Part No. 950-110
O.E. No. 529-035-949
All 4 Tec's with Super Chargers



Crankshaft Locking Tool
Part No. 950-125
O.E. No. 529-035-821
Fits: All 4 Tec's



4-Pin Socket
Part No. 950-195
O.E. No. 529-035-948
Fits: 4-Tec Supercharged



Pressure Cap
Part No. 950-105
O.E. No. 529-035-843
Fits: GTX 4 Tec



Steering Cable Nut Removal Tool
Part No. 950-130
O.E. No. 295-000-145
Fits: All Models

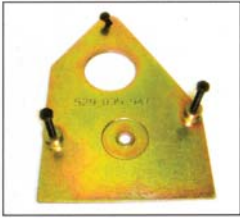

Support Plate 4-TEC Supercharged Engines
Part No. 950-190
O.E. No. 529-035-947
Fits: 4-Tec Supercharged

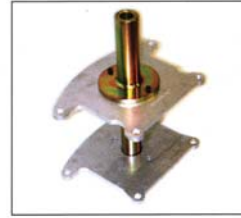

Alignment Support Plate kit
Part No. 950-135
O.E. No. 529-035-506
Fits: All Models



Camshaft Locking tool
Part No. 950-180
O.E. No. 529-035-839
Fits: 4-Tec Engines



Alignment Shaft
Part No. 950-140
O.E. No. 529-000-141
Fits: All Models



Drive Shaft Holder
Part No. 950-155
O.E. No. 529-035-986
Fits: GTX 4-Tec & RXP 4-Tec Models



Seal & Bearing Pusher
Part No. 950-165
O.E. No. 529-035-955
Fits: GTX 4-Tec Models



Shaft Pusher
Part No. 950-170
O.E. No. 529-035-819
Fits: GTX 4-Tec Models



Ring Gear Blocking Tool
Part No. 950-175
O.E. No. 529-035-946
Fits: 787 RFI Engines & 947 DI Engines



Ball Bearing Support Pusher
Part No. 950-200
O.E. No. 529-035-950
Fits: 4-Tec Supercharged



Ring Gear Blocking Tool
Part No. 950-172
O.E. No. 529-035-846
Fits: 529035846

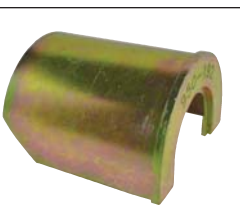

PTO Support Tool
Part No. 950-192
O.E. No. 529-035-842



Drive Shaft 'C' Clip Remover
Part No. 950-205
O.E. No. 529-036-026

FOUR STROKE
INTAKE SYSTEMS
ENGINE/GASKETS
EXHAUST
DRIVE LINE HANDLING
ELECTRICAL
WATERLINE /BILGE
STEERING & CONTROLS
BODY
ACCESSORIES
SERVICE TOOLS /HARDWARE
CHEMICAL

FOR SEA-DOO ENGINE



R&D SUPERCHARGER REBUILD TOOL KIT

R&D has designed a custom tool kit that is essential in the rebuilding process of the Sea-Doo Supercharger. All tools are specific in application and are CNC machined to ensure a precision job.

Description	Part No.
A. Supercharger Holder Tool	613-96005
B. Bearing Puller/Installer Tool	613-96006
C. Seal/Bearing Retainer Torx Wrench	613-96008
D. 215HP 16 Tooth Drive Gear Tool	613-96016
D. 185HP 17 Tooth Drive Gear Tool	613-96017
E. 185HP Clutch Drive / Lock Washer Tool	613-96018
E. 215HP Clutch Drive / Lock Washer Tool	613-96019

*NOTE: Kit comes with a S/C holder, bearing puller/installer tool, drive gear tool and clutch drive/lock washer tool.



RIVA SEA-DOO SUPERCHARGER SHAFT HOLDER TOOL

Our Sea-Doo Supercharger Shaft Holder Tool makes servicing your supercharger a snap. Ergonomically designed billet handle allows a sure, firm grip without fatiguing your hand. Working ends are made from heat treated tool-grade steel to resist wear and are oversized to prevent flexing. A must for every mechanic's tool box!

Description	Part No.
RIVA Sea-Doo SC Shaft Holder Tool	RS1750-ISH-949



TORX® SOCKET SET FOR SEA-DOO

Special Star Sockets for Sea-Doo 4-Tec & DI engine bolts are made from heat-treated vanadium steel and black oxide coated for durability. Sockets are kept in a convenient vinyl holder.

- Four 3/8" Drive Sockets (T10, T12, T14, T16) • Three 1/4" Drive Sockets (T6, T7, T8)

Description	Part No.
Torx Socket Set	LS26750



TORX® BIT SET FOR SEA-DOO ENGINES

Seven 1/4" Hex Insert Bits with 1/4" Drive Bit Holder. T-10 through T-40.

Description	Part No.
Torx Bit Set	LS26000

FOR SEA-DOO ENGINE



SD 4-TEC VALVE COMPRESSION TOOL

Our overhead Valve Compression Tool allows easy removal of valve springs and keepers without removing cylinder head. Includes compression adapter to pressurize cylinder keeping valves in place during removal of stock springs and keepers.

Description	Part No.
SD 4-TEC Valve Compression Tool	RS19050-VCT

FOR YAMAHA 1.8L ENGINE

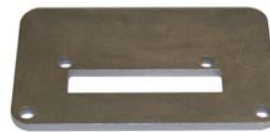

F.



G.

R&D SPECIALTY SUPERCHARGER TOOLS FOR YAMAHA 1.8L ENGINE

R&D has designed a custom tool kit that is essential in the rebuilding process of the Yamaha Supercharger. All tools are specific in application and are CNC machined to ensure a precision job.

Description	Part No.
F. Supercharger Housing Holder Bracket Tool	612-92010
G. Shaft/Gear Holding Tool	612-92011



R&D SUPERCHARGER CLUTCH REMOVAL TOOL FOR YAMAHA 1.8L ENGINE



This R&D tool enables the clutch to be changed in a matter of only minutes. With the supercharger and front engine cover removed the tool drops down through the case and secures the drive gear at the front of the crankshaft from rotating when the clutch is removed and installed. This is a "must have" tool that will save massive amounts of time for any mechanic.

Description	Part No.
R&D Supercharger Clutch Removal Tool	612-92012



FLYWHEEL PULLER

Description	Part No.
Most Yamaha 4 Stroke PWC Models	MP#10

FOR YAMAHA 1.8L ENGINE

Installation



Removal

RIVA ENGINE VALVE SEAL TOOL

This handy tool provides easy removal and installation of valve stem seals on Yamaha 1.8L engines. Allows seal installation during fitting of valve train upgrade kit without removing cylinder head.

- Prevents seal distortion & gouging.
- Precision machined from 6061 aluminum & anodized.
- Knurled handle for positive grip.

Description Valve Seal Tool for Yamaha 1.8L Engine **Part No.** RY19040-VST



TORQUE ANGLE METER

For All Torque-to-Yield Fastener Applications. Commonly used for tightening head bolts & other bolts where a torque angle is required. Use with 1/2" drive.

Description Torque Angle Meter **Part No.** LS28100

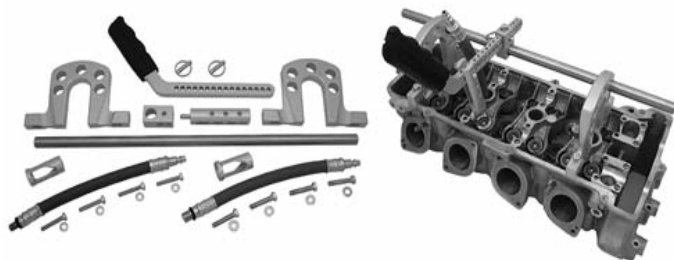

RIVA VALVE COMPRESSION TOOL

RIVA's overhead Valve Compression Tool allows easy removal of valve springs and keepers without removing cylinder head. Includes compression adapter to pressurize cylinder keeping valves in place during removal of stock springs and keepers. Fits both Yamaha 1.8L & Kawasaki 1.5L 4-stroke engines.

Description RIVA Valve Compression Tool Fits Yamaha 1.8L & Kawasaki 1.5L 4-stroke **Part No.** RY19040-VCT

FOR YAMAHA 1.8L ENGINE



FZR CAM TENSIONER TOOL

The R&D Cam Tensioner Tool is designed to mechanically spring preload the cam chain in order to set and verify cam timing. This eliminates the process of pressurizing the hydraulic cam tensioner to verify cam timing.

Description R&D FZR Cam Tensioner Tool **Part No.** 612-92015



DRIVELINE COUPLER WRENCH

Description Driveline Coupler Wrench for SHO, FZR, VXR, VXS **Part No.** 132-57002

FOR KAWASAKI ENGINE



R&D ULTRA 250/260X SUPERCHARGER WHEEL PULLER TOOL

The R&D wheel puller tool makes it fast and easy to remove a supercharger wheel without the removal of the intercooler system or the water muffer assembly. The R&D Supercharger drive wheel puller will save at least an hour on a pulley removal and replacement. A must have tool.

Description R&D Ultra 250/260X SC Wheel Puller Tool **Part No.** 611-26004



R&D ULTRA 250/260X DRIVER WHEEL HOLDER TOOL

The R&D Holding Tool makes it fast and easy to remove and re-install a supercharger wheel without damaging or breaking the wheel hub. Use the holding tool to properly torque the drive bolts and main spline drive bolt. A must have tool.

Description Ultra 250/260X Driver Wheel Holder Tool **Part No.** 611-26003



R&D DRIVE LINE COUPLER REMOVAL TOOL (CRANKSIDE)

Description Ultra 300/310 Crankside Coupler Wrench **Part No.** 132-57003

FOUR STROKE

INTAKE SYSTEMS

ENGINE/ GASKETS

EXHAUST

DRIVE LINE HANDLING

ELECTRICAL

WATERLINE /BILGE

STEERING & CONTROLS

BODY

ACCESSORIES

SERVICE TOOLS /HARDWARE

CHEMICAL



CARB SCREW ADJUSTING TOOL

Angled head for the hard-to-reach carb adjustment screws

Description	Part No.
Carb Screw Adjusting Tool	08-0119



90 DEGREE 1/4" HEX DRIVER

Precision made of high-grade aluminum & stainless steel. Designed for hard-to-reach pilot screw. Gear driven 1/4" hex. Includes 1/4" hex bits, straight slot, Phillips, D-shaped pilot screw bit, 6mm hex jet bit and 1/4"-hex-to-1/4" drive bit.

Description	Part No.
90 Degree 1/4" Hex Driver	08-0229



ONE-HANDED OPERATION

HOSE PINCHER

Clamps and holds hoses up to 3/4" inside diameter. Angled jaws close to create a complete seal every time. Jaws are offset for hard-to-reach areas. The handles lock firmly to hold the jaws in closed position.

Description	Part No.
Hose Pinchers	LS23000

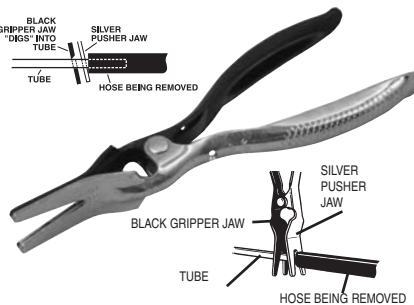
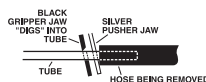

HOSE REMOVAL PLIERS

For easy removal of 5/32" to 1/2" (4mm to 14mm) hoses. Engage the tube (line) with the black jaw. This sharpened jaw actually "digs" into the tube to grip it! Squeeze, and the hose is easily pushed off by the silver jaw.

Description	Part No.
Hose Removal Pliers	LS47900

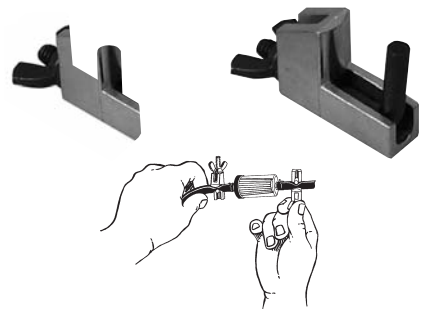

HOSE PINCHERS

Quick, easy way to pinch off fuel lines, etc. without damaging the line. Sold two per set.

Description	Part No.
Hose Pinchers	LS22850



MIKUNI POP-OFF GAUGE

For Accurate adjustment of pop off pressure levels for fine tuning requirements.

Description	Part No.
Mikuni 30 Lbs. Guage	MK-BN PMP
Mikuni 60 Lbs. Guage	MK-BN PMP-60
Mikuni 100 Lbs. Guage	MK-BN PMP-100



MIKUNI TOOL KIT

This handy little kit contains all the tools necessary to make jetting change, perform normal maintenance as well as disassemble and rebuild any Mikuni carburetor

Description	Part No.
Mikuni Tool Kit	MK-404



ROTARY VALVE TIMING WHEEL

Description	Part No.
Rotary Valve Timing Wheel	012-170



ENGINE SERVICE TOOLS

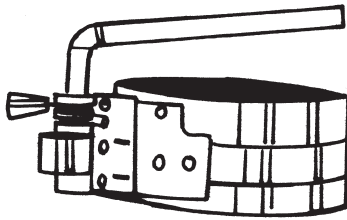

QUICK RELEASE RING COMPRESSOR

Ring Compressor makes it easy to remove ring from piston. Range is from 2-1/8" - 5" (54mm-127mm).

Description Quick Release Ring Compressor
Part No. LS19000

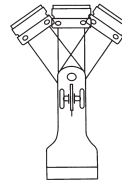

Locks in 3 Different Positions.

FOLD-UP SCRAPER

The fold-up scraper features three arm positions and a slanted blade for proper scraping. Great for removing decals, etc.

Description Fold-up Scraper
Part No. LS52400

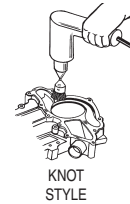

KNOT STYLE



14040

1" WIRE END BRUSHES

Made with .020" industrial heat-tempered wire. Use with portable electric and air tools. 20,000rpm maximum safe speed.

Description 1" Knot Wire End Brush
Part No. LS14040

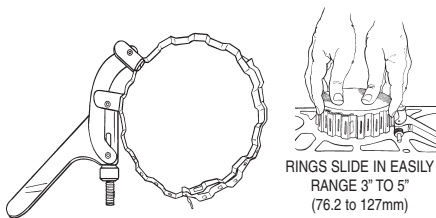

RINGS SLIDE IN EASILY RANGE 3" TO 5" (76.2 to 127mm)

WRINKLE BAND RING COMPRESSOR

Wrinkle band cuts friction in half. Rings slide in easily 3" - 5" (76.2mm - 127mm).

Description Wrinkle Band Ring Compressor
Part No. LS21700

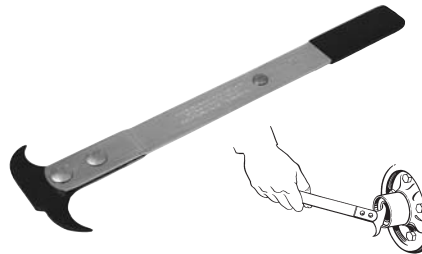

SEAL PULLER

Simply insert the tip of the tool behind the oil or grease seal, press and pull. Leverage works for you. Two size tips reach in and fit nearly all seal applications.

Description Seal Puller
Part No. LS56750

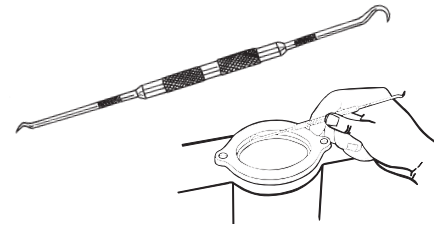

"O" RING AND SEAL PICK

Quickly removes and installs "O" rings and seals. Tips are hardened to stay sharp.

Description "O" Ring and Seal Pick
Part No. LS31840

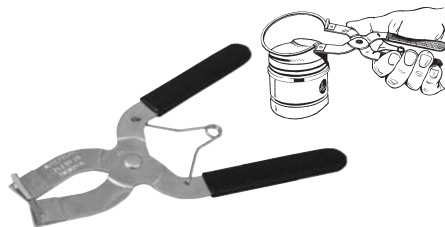

PISTON RING INSTALLER

Description Piston Ring Installer
Part No. LS33500



PISTON PIN PULLER

Universal piston pin puller easily removes all sizes of piston pins without any damage to the piston.

Description Piston Pin Puller
Part No. 012-152

CONVERSION TABLE

Unit	Conversion
Linear Measure	
centimeter (cm.)	0.3937 inch
meter (m.)	3.2808 feet / 39.37008" / 1.0936 yards
kilometer (km.)	0.6214 mile
inch (in.)	2.54 centimeters
foot (ft.) = 12 inches	30.48 centimeters
yard (yd.) = 3 feet	0.914 centimeters
rod (rd.) = 5.5. yards	5.0292 meters
chain (ch.) = 4 rods	20.117 meters
furlong (fur.) = 10 chains	201.17 meters
mile (m., mi.) = 8 furlongs	1.6093 kilometers
league (l.) = 3 miles	4.8279 kilometers
Avoirdupois Weight	
Gram (g.)	0.0353 oz. avdp.
kilogram (kg.) = 1,00 grams	2.2046 lb. avdp
metric ton (M.T.)	1.1023 short tons
	0.9842 long ton
grain (gr.)	0.0648 gram
dram (dr. avdp.) = 27.34 grains	1.7718 grams
ounce (oz. avdp.) = 16 drams	28.3495 grams
pound (lb. avdp) = 16 ounces	0.4536 kilogram
hundredweight (cwt.)	
(US) = 100 pounds	45.3592 kilograms
(UK) = 112 pounds	50.8024 kilograms
ton (t., tn.)	
(US) = short ton	
=2,000 pounds	0.907 metric ton
(UK) = short ton	
=2,240 pounds	1.106 metric ton



COMPRESSION TESTER

Contains hoses for 10, 12 & 14mm spark plug applications. Features a quick disconnect with a pressure release valve and a 300lbs. Gauge. Packed in a convenient carry box. Made in USA.

Description Compression Tester
Part No. 08-0188

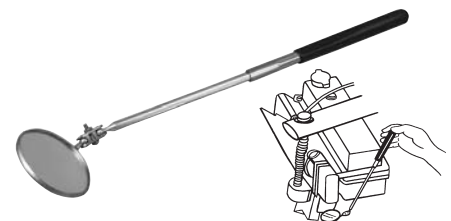

TELESCOPING MIRROR

Enables you to see around corner. 2-1/4" diameter mirror swivels to any position. Length extends from 10" to 14".

Description Telescoping Mirror
Part No. LS32050

FOUR STROKE
INTAKE SYSTEMS
ENGINE/GASKETS
EXHAUST
DRIVE LINE HANDLING
ELECTRICAL
WATERLINE /BILGE
STEERING & CONTROLS
BODY
ACCESSORIES SERVICE TOOLS /HARDWARE
CHEMICAL



PRO-CRIMP TOOL

To do a job right, it is important to have the right tools. If you custom build a lot of plug wires, the Pro-Crimp is the right tool for you! The Pro-Crimp features a hardened steel frame, molded hand grips and built-in ratchet action that is also adjustable. The tool is supplied with jaws to fit MSD's Super Conductor Spark Plug wires and can be removed to use additional jaws (sold separately) for crimping common wiring terminals.

Description	Part No.
MSD Pro Crimp Tool (Includes #3508 Spark Plug Dies)	35051
Spark Plug Dies	3508
Amp Pins	3506
Amp Lug Dies	3507
Weathertight Dies	3509
Deutsch Terminal Dies	3510



TERMINAL DETENT TOOL

The hollow barrel allows you to depress the tab on the terminal end and to remove the wire from the connector without damaging its ends.

Description	Part No.
Terminal Detent Tool	59-0254

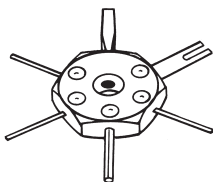

TERMINAL REMOVAL TOOL

Includes six different shaped blades.

Description	Part No.
Terminal Removal Tool	LS14900



DEUTSCH REMOVAL TOOL

This stainless steel tool is designed to easily disassemble Deutsch connectors. The flat end slides under plug wedges to release them from the housing. The hook end hooks onto the receptacle wedge to release from the housing and it can separate holding fingers to allow for the pin and socket to be removed.

Description	Part No.
Deutsch Connectors Removal Tool	14114100



TIMING DEGREE WHEEL

Set total loss timing with no guess work. Check crank shaft timing to exact degree. A must for porting and port timing.

Description	Part No.
Timing Degree Wheel	08-0092



2015 IFA FREERIDE
WORLD CHAMPION MARK GOMEZ.
PHOTO COURTESY OF JIN OMURA.



FLYWHEEL PULLER

Sea-Doo	Part No.
800/951 38mm x 1.5	MP#42
Kawasaki	Part No.
900/1100 35mm x 1.5	MP#29
1200 STX-R,	MP#64
Ultra 150 33mm x 1.5	



FLYWHEEL/MAGNETO PULLER

Sea-Doo	Part No.
580/650/720	MP#37
12 Hole Disc 8mm Bolts	
Polaris	Part No.
Polaris All & Universal	MP#37
12 Hole Disc 8mm Bolts	
Yamaha	Part No.
580/650/Pre 94 701	MP#37
12 Hole Disc 8mm Bolts	
701/760/800/1100/1200	MP#37
12 Hole Disc 8mm Bolts	
Most 4-Stroke Yamaha	MP#10
PWC Models	
Kawasaki	Part No.
300/440/550/650	MP#37
12 Hole Disc 8mm Bolts	



Kawasaki	Part No.
750/800	MP#18
Special 18mm x 1.5 Right Hand Bolt	



LC-2: DIGITAL WIDEBAND "LAMBDA" O² CONTROLLER

Key Features Include:

- Patented DirectDigital™ Wideband Technology
- Wideband O² Compatible with ALL fuel types
- Ability to calibrate O² sensor for maximum accuracy
- Integrated dual-color status LED (Green/Red)
- Two configurable linear 0-5v analog outputs
- Optional sensor cable lengths available: 3ft., 8ft. (Included), and 18ft.
- Positive lock connectors for all connections
- Innovate MTS serial in/out
- Serial connection to your PC
- Real-time display data on screen and/or with powerful LogWorks software

Description

LC-2: Complete Lambda Cable Kit
Includes: LC-2 Controller, Bosch Wideband O² Sensor (LSU4.2), **8 ft. Sensor Cable (overall length 10 ft.)**, 1" Mild Steel Exhaust Bung, Program Cable (Only needed for Datalogging and to change the Fuel Type setting), Manual, LogWorks Software (Free Download).

Part No.

INN-3877



MTX-L: WIDEBAND AIR/FUEL RATIO GAUGE ALL-IN-ONE

Key Features Include:

- The only 100% digital wideband air/fuel ratio technology!
- Water Resistant 52mm (2-1/16") round dash-mountable casing is perfect for automotive, powersports, marine, and demanding racing applications
- Built-In Direct Digital™ Wideband Controller reduces wiring and simplifies installation (No LC-1 required)
- Wideband O² sensor is compatible with all fuel types (Leaded, Unleaded, Diesel, Methanol, E85, etc.)
- Ability to calibrate O² sensor for increased accuracy
- (2) 0-5v fully programmable linear analog outputs for use with engine management systems "closed-loop" and external dataloggers
- Interchangeable faceplates and bezels: Black and silver bezel, black and white faceplates included
- Large digital readout and programmable "Digital Needle" provides the functionality of a needle style gauge with the pinpoint accuracy of a digital display
- Datalog using LogWorks on your PC
- Serial IN and OUT ports allows for easy connection with other Innovate MTS and other devices

Description

MTX-L: Complete All-In-One Air/Fuel Ratio Gauge Kit
Includes: Gauge, Silver Bezel, Black Bezel, White Faceplate, Black Faceplate, Bosch Wideband O² Sensor (LSU4.2), **8 ft. Sensor Cable (overall length 10 ft.)**, Exhaust Bung, Program Cable (Only needed for Datalogging and to change the Fuel Type Setting), Software CD, and Quick Start Guide

Part No.

INN-3844



IGNITION SYSTEM SPARK TESTER

This ignition system tester checks the integrity and strength of your system by gauging your systems spark.

Description

Ignition System Spark Tester

Part No.

08-0122



SPARK PLUG WIRE TESTER

Now you can check spark plug wires without piercing the wires. Light flashes indicating sound wire.

Description

Spark Plug Wire Tester

Part No.

LS26900



JUMPER CABLES

8 feet long heavy duty 8 gauge copper jumper cables are big on charging power, yet stow conveniently in the 9 x 9 inch nylon bag.

Description

Jumper Cables

Part No.

59-0530



12 VOLT DC BATTERY TESTER

The 12 volt DC automotive tester quickly indicates alternator output and status of battery charge. The tester features a durable case with a magnetic strip on the back that adheres to any steel surface for safe operation. Features LED lights that show normal, low or flat level of battery charge.

Description

12 Volt DC Battery Tester

Part No.

991085

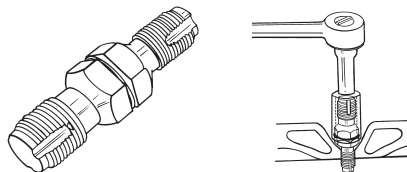

SPARK PLUG HOLE THREAD CHASER

Cleans threads in spark plug hole. Use with 13/16" spark plug socket. Double-ended for both 14mm and 18mm threads.

Description

Spark Plug Hole Thread Chaser

Part No.

LS20200

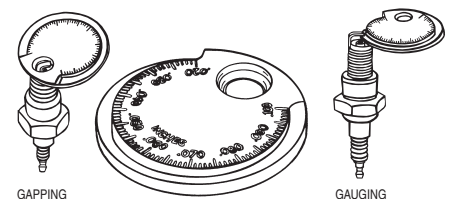

STANDARD/HIGH ENERGY SPARK PLUG GAUGE & GAPPER

Gauge and gap all types of spark plugs from .020" to .110 (.50mm to 2.53mm).

Description

Spark Plug Gauge and Gapper

Part No.

LS67870

FOUR STROKE
INTAKE SYSTEMS
ENGINE/GASKETS
EXHAUST
DRIVE LINE HANDLING
ELECTRICAL
WATERLINE /BILGE
STEERING & CONTROLS
BODY
ACCESSORIES
SERVICE TOOLS /HARDWARE
CHEMICAL



DC-800



DC-1200



003-310



DRIVE COUPLER REMOVAL TOOLS

Kawasaki	Part No.
Drive Coupler Removal Tool	DC-800
Kawasaki 440/550/650/750/800 & Polaris Octane	
Hydrospace Drive Coupler Removal Tool	DC-1200
Coupler Puller 12F/15F	003-310
Ultra 150/250/260	



WATCON INTAKE/SCOOP GRATE DEPTH GAUGE

Most savvy tuners are sure to set their intake grates to the maximum IJSBA allowed limits for the best hook-up possible. Watcon's "Depth Gauge" has been manufactured to the Official IJSBA Rule Book specifications.

Description	Part No.
Watcon Intake Scoop Grate Depth Gauge	IJSBA-1

**THE WATCON DEPTH GAUGE HAS BEEN MANUFACTURED TO THE SPECIFICATIONS IN THE IJSBA RULE BOOK, ALL FINAL DECISIONS ON THE LEGAL DEPTH ARE THE DECISION OF EACH RACE DIRECTOR AND THE TECHNICAL INSPECTOR FOR EACH RACE SITE.*



R&D'S "BIG ASS" PROP WRENCH

Description	Part No.
Fits Skat-Trak Prop Tool for SHO/FZR/FZS/GPR/HO/FX/VX Hex size 1"	132-56003



A.

B.

IMPELLER WRENCH TOOL

Holds spline of drive shaft for removal of impeller.

Sea-Doo	Part No.
A. 580/650/720/800/951 All, Spark	TOOL#23
18mm spline, 18 tooth	
Polaris	Part No.
B. Polaris ALL & long reach univ.	TOOL#38
20mm spline, 20 tooth	



C.

D.

IMPELLER WRENCH TOOL

Sea-Doo	Part No.
C. GTX 4Tec Super Charged	TOOL#70
22mm spline, 22 tooth	
D. RXP/RXT 27MM	TOOL#71
27mm spline, 28 tooth	



SOLAS IMPELLER WRENCH TOOL

Sea-Doo	Part No.
RXP/RXT 27mm spline	WR012-SRX



E.

F.

IMPELLER WRENCH TOOL FOR KAWASAKI

Kawasaki	Part No.
E. 650/750/800/900/1100 & Ultra 250/260/300	TOOL#23
18mm spline, 18 tooth	
F. 550-89	TOOL#24
14mm spline, 6 tooth	



G.

H.

I.

DRIVE SHAFT HOLDING TOOL FOR YAMAHA

Yamaha	Part No.
G. WR500, WJ650LX	TOOL#27
16mm spline, 14 tooth	
H. 650/701/760/1100/1200	TOOL#32
18mm spline, 16 tooth	
I. GP1200R	TOOL#56
20mm spline, 18 tooth	
SHO/FZR/FZS/VXR/VXS	TOOL#53
22mm spline, 20 tooth	



TOOL# 61-5

TOOL# 60-3

DRIVE COUPLER TOOLS

Use to remove drive coupler from crankshaft and sub-shaft.

Yamaha	Part No.
650/701	TOOL#60-3
760/800/110/1200	TOOL#61-5
Kawasaki	Part No.
440/550/650/750/800	DC-800



WATCON IMPELLER PITCH GAUGES

It's a known fact; not all impellers are created equal. Sometimes when impellers are mass produced, there are subtle differences that can affect performance. Use this simple tool to measure the pitch angle and blade length of each blade throughout its circumference. This enables you to make adjustments to the pitch where needed. Great for fine tuning, making minor changes or verifying pitch when sending impellers off for repair.

Description	Part No.
140-142mm Impellers	IMP-142
144-148mm Impellers	IMP-148
155-160mm Impellers	IMP-160

SHOP TOOLS



STUD TOOL

Economy stud installation and removal tool. The kit includes three sizes: 6mm, 8mm and 10mm.

Description	Part No.
Economy Stud Tool Kit	WJ7710



STUD INSTALLATION TOOLS

Will install cylinder and intake manifold studs. Hex head is 3/4" or 19mm.

Description	Part No.
6mm x 1.00 Stud Tool	08-0149
8mm x 1.25 Stud Tool	08-0150
10mm x 1.25 Stud Tool	08-0151



HEX-PRO AND STAR-PRO PIVOT HEAD WRENCHES

- Pivot design allows for easy rotation around obstructions
- Heat treated alloy tool steel
- Includes heavy duty folding canvas storage pouch

Description	Part No.
Hex-Pro Metric	08-0420
Hex-Pro SAE	08-0419
Star-Pro	08-0421

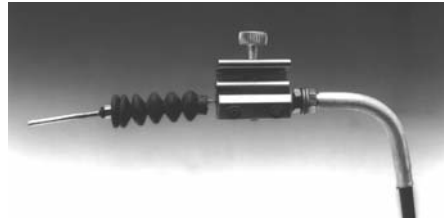

CABLE LUBBER

Installs quickly and helps free up corroded or tight cables. Note; Damaged cable should be replaced.

Description	Part No.
Cable Lubber	59-0250



T-HANDLE RATCHET

Features a compact design that allows it to be used even in tight spaces.

Description	Part No.
1/4" T-Handle Ratchet	08-0231
3/8" T-Handle Ratchet	08-0226



SCRATCH BRUSH

Removes rust, scale, paint, and solder from metal surfaces.

Description	Part No.
A. Shoe Handle Scratch Brush	LS14180
B. Scratch Brush	LS14160

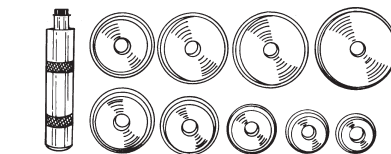

SET INCLUDES ONE OF EACH OF THE FOLLOWING DRIVERS:

DRIVER PART NO.	SIZE
12610	1.565"
12620	1.750"
12630	1.965"
12640	2.325"
12710	2.470"
12650	2.555"
12690	2.830"
12700	2.995"
12970	3.180"

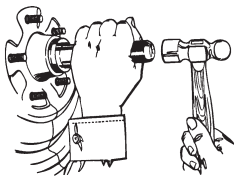

BEARING RACE AND SEAL DRIVER—MASTER SET

Make it easier to insert bearing race and seals without damage to race. This master set includes nine drivers to fit most standard bearings.

Description	Part No.
Bearing Race and Seal Drive	LS12980



MAGNETIC SOCKET HOLDERS

Standard and deep sockets fit on one convenient holder with powerful magnets, securely holding on to any steel surface. Red color only.

Description	Part No.
1/4" Holder with 26 Compartments	LS40120

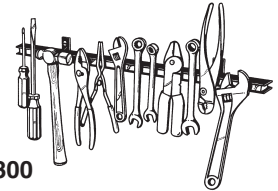

MAGNETIC TOOL HOLDERS

Powerful magnet holds even heavy hand tools. Ideal for both home and shop.

Description	Part No.
13" Long Magnetic Tool Holder	LS21300

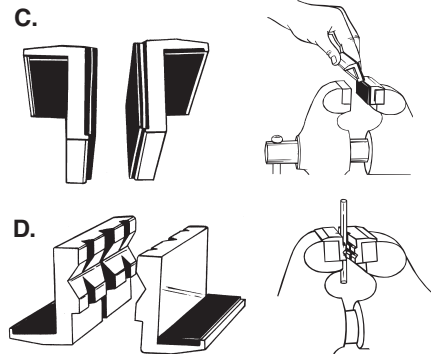

RUBBER-FACED & ALUMINUM VISE JAW PADS

These vise jaw pads are designed to protect delicate parts from damage. Sold in pairs.

Description	Part No.
C. Rubber-faced Vise Jaw Pads	LS48100
D. Aluminum Vise Jaw Pads	LS48000

FOUR
STROKE

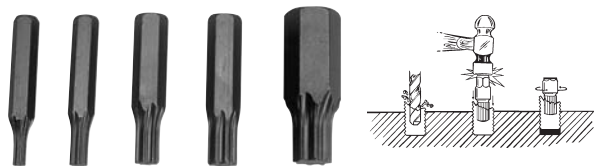

SUPER OUT EXTRACTOR SET

A super strong extractor set made of a special hardened, shock-resistant tool steel. Works on both left and right hand threads. Super Outs cut their way straight into bolts, eliminating wedging or further tightening of frozen bolts and screws. Five extractor sizes extract 1/4" to 1/2" and larger bolts and screws.

Description	Part No.
Super Out Extractor Set	LS62900

INTAKE
SYSTEMS

ENGINE/
GASKETS

EXHAUST

DRIVE LINE
HANDLING

ELECTRICAL

WATERLINE
/BILGE

STEERING
& CONTROLS

BODY

ACCESSORIES

SERVICE TOOLS
/HARDWARE

CHEMICAL



3/8" HAND IMPACT TOOL SET

Loosens Rusted, Frozen Nuts, Bolts and Screws. Unique design delivers over 200 ft. lbs. of Shock Torque. Can be reversed to tighten. Can also be used with impact sockets!



- Impact Set Includes:**
- 3/8" Impact Tool #3 Phillips Bit
 - 3/8" Bit Holder #4 Phillips Bit
 - #1 Phillips Bit 3/8" Straight Slot Bit
 - #2 Phillips Bit

Description	Part No.
3/8" Hand Impact Tool Set	LS29200



T-HANDLE BIT DRIVER SPINNER

- Bearing mounted spinner provides faster and easier removal and installation of bolts and nuts
- 5/16" hex drive head accepts most common driver bits
- Magnet inside drive head holds drive bits firmly in place

Description	Part No.
T-Handle Bit Driver Spinner	08-0556



ATLANTIS SHOP LANYARD

Not legal for riding. For shop testing and repairs only.

Description	Part No.
KPTW, Yamaha, Sea-Doo	A3240
KPTW, Yamaha, Sea-Doo DESS	A3250

*These lanyards are not compatible with the Sea-Doo Spark.



RATIO RITE CUP & LID

With Ratio Rite measuring cup get a perfect mix every time. Fill to the pre-calibrated ratio mark and pour into gas. Ratios are from 16:1 to 44:1 for up to 12 gallons. Calibrations also include oz., CCs, and pints.

Description	Part No.
Ratio Cup	59-0548
Ratio Rite Cup Lid	59-0582



Oil Filter

"SWIVEL GRIP" OIL/FUEL FILTER WRENCH

For smaller 2 3/8" to 2 5/8" oil filters. For small oil and fuel filters. Tough stainless steel band with special "teeth" for extra gripping power...won't slip. Special narrow 1/2" band fits in tight spots. Handle swivels to clear obstructions and makes it easy to turn in hard to reach locations. Vinyl covered handle. Covers a range of 2 3/8" to 2 5/8" (60.3 - 66.7mm)

Description	Part No.
"Swivel Grip" Oil / Fuel Filter Wrench	LS54400



4.5 GALLON DRAIN PANS

Now with built-in-ribs for draining filters in the pan. For easy transfer of liquids. High-density polyethylene material is resistant to chemicals and solvents, and is easy to clean. 1" wide diameter spout for quick and easy pouring. The anti-splash lip and baffles help prevent spilling when carrying or pouring. Comes with large, easy-grip handles.

Description	Part No.
4.5 Gallon Oil Drain Pan, Black	LS17942
4.5 Gallon Oil Drain Pan, Green	LS17952

FOREIGN SUBSTANCE REMOVAL TOOLS FOR INTAKE GRATE/PUMP AREA



Description	Part No.
Foreign Substance Removal Tool - 15" Long	LS83040



Picks up loose parts in hard-to-reach areas. 23" flexible cable allows you to get into hard-to-reach areas. Simply push button on handle and fingers open 3/4" to grab small parts that you can't reach by hand

Description	Part No.
23" Flexible Retrieving Tool	LS31140

ThreeBond



1211AT100

THREBOND SILICONE GASKET

#1211 (White) Silicone Liquid Gasket

High grade silicone liquid gasket used by many OEMs in aluminum case assembly. 1211 is tack free in 90 minutes and fully cured in 24 hours.

Description	Part No.
Silicone Liquid Gasket (White)	1211AT100



1207B100G

#1207B (Black) Quick Dry Silicone Gasket

Crankcase sealer for large gaps, sheet metal, tough to seal areas, and vertical applications. 1207B is tack free in 5 minutes and fully cured in 24 hours.

Description	Part No.
Quick Dry Silicone Liquid Gasket (Black)	1207B100G

ThreeBond

THREAD LOCK

(Red Label)

Medium Strength Bearing & Stud Lock #1333B

Retain high-strength properties for bearings and studs. Apply heat to soften for easier removal.



Description	Part No.
Medium Strength Thread Lock - 50ml	1333B50C



H70GG-12



ODI GRIP GLUE

Description	Part No.
Grip Glue, 5 ml	H70GG
Grip Glue, 12 pack of 5 ml	H70GG-12

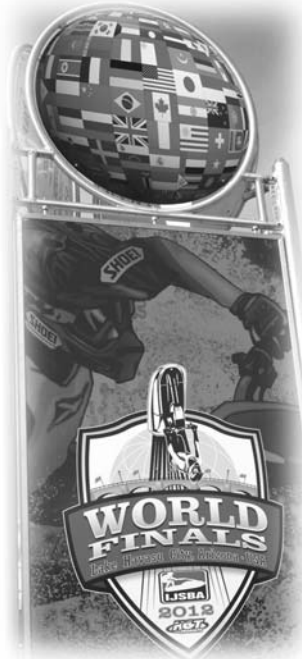

HOT PRODUCTS WAS THE PROUD TITLE SPONSOR OF THE 31ST AND 32ND JISBA WORLD FINALS.

PHOTOS COURTESY OF JIN OMURA



ThreeBond

THREBOND GRIP LOCK

A high strength adhesive specially formulated to keep grips in place without damaging the rubber. Ideal for Snowmobile, Motorcycle, ATV and Personal Watercraft

Description	Part No.
ThreeBond Grip Lock 30gm (Dealer)	TB1501C



FOUR STROKE	INTAKE SYSTEMS	ENGINE/GASKETS	EXHAUST	DRIVE LINE HANDLING	ELECTRICAL	WATERLINE /BILGE	STEERING & CONTROLS	BODY	ACCESSORIES SERVICE TOOLS /HARDWARE	CHEMICAL
-------------	----------------	----------------	---------	---------------------	------------	------------------	---------------------	------	-------------------------------------	----------

LAST MINUTE NEW PRODUCTS



Bullett Racing V2 Hydro Race Hull

The Bullett Racing V2-WideBoy Hydrospace with molded tubbies has the same look as the original Hydrospace, with the exception of the bottom. The bottom on the V2 is a race-bred and proven design that has been winning championships over the past few years on every continent. This hull was built around the intake system of the boat, with no compromises in race conditions. Bullett Racing only uses the highest quality materials on the market, all of our composite products are built with AME 6000 Pure Epoxy Vinyl Ester Resins. The hull comes with a composite deck and bottom, composite bulkhead, carbon fiber ride plate for rigidity and memory retention, Bullett Racing proprietary intake system (with intake shoe and intake grate), and composite hood (with four air intake tubes, tucked high up in the hood – making it the most water-tight hood on the market). The hull also comes with front and rear bow eyes, 2.5" exhaust, hull extensions, bond flange wedges, steering cable tube, two 1/2" water lines, 5/8" trim cable tube, and motor mount holes pre-drilled for either Hydrospace configuration. Deck and bottom are glued together with a high strength bonding glue, and all hulls are pre-finished on the inside with white gel-coat and black splatter. Bullett Racing has proven time and time again that if you want to be on the podium, you're going to need a Bullett Racing Race Hull. No internet propaganda, just race-proven results!

Includes: Top Deck, Bottom Hull, Hood, Carbon Nose Cowl, Carbon Hull Extensions, Ride Plate, Pump Shoe, Intake Grate, Drive Shaft, Dual Cooling Lines, Trim Cable Tube, 2.5" Exhaust. Hulls are pre-drilled for Motor Mounts, Carrier Bearing, Pump, Gas Cap, Handle Pole Bracket, and Drain Plugs. Gas Tank and Water Box Tabs are also installed.

HULL SPECIFICATIONS

Design Purpose: Racing and Recreational
 Hull Weight : 105
 Hull Length: 96"
 Hull Width: 35"

HULL OPTIONS

Material Options: Fiberglass with epoxy resin for weight saving is standard. Carbon Fiber is an option for an additional cost.
Color Options: Black and White Standard, Metal Flake Colors are optional with an additional cost.
Graphics Included: The Bullett Racing Graphic kits are optional with an additional cost.
Matting Included: Pre-Installed Jettrim Mats are optional with an additional cost.

Intended Fuel Tank: Standard Hydrospace Fuel Tank
Intended Intake Grate: Bullett Racing Single Bar Intake Grate
Intended Ride Plate: Bullett Racing Carbon Fiber Ride Plate
Scupper Valve: Pre-Drilled
Trim Tube: Yes
Number of Cooling Lines: 2
Exhaust Size: 2.5"

ENGINE AND PUMP SPECIFICATIONS

Engine Size Range Accepted: Webber Motor
 Pump Size Range Accepted: Hydrospace 140mm – 145mm



Bullett Racing V2 Blaster Race Hull

In just 2 years of competition, the Bullett Racing V2 Blaster Hull has won 2 World Titles as well as the Jettripe Westcoast Nationals. The Bullett Racing Blaster Hull utilizes the stock seat and hood components from a Yamaha B1 Blaster. In addition to those parts, we also use the OEM gas tank, and that's where it stops. The hull is ready to be equipped with a Kawasaki 1100 power plant and propulsion system. Bullett Racing has proven time and time again that if you want to be on the podium, you are going to need a Bullett Racing Race Hull. No internet propaganda, just race-proven results!

Includes: Top Deck, Bottom Hull, Hood, Hood Skin, Carbon Hull Extensions, Molded-in Tubbies, Ride Plate, Pump Shoe, Intake Grate, Drive Shaft, Dual Cooling Lines, Trim Cable Tube, 2.5" Exhaust. Hulls are pre-drilled for Motor Mounts, Carrier Bearing, Pump, Gas Cap, Hood and Seat Hardware, and Drain Plugs. Gas Tank and Water Box Tabs are also installed.

HULL SPECIFICATIONS

Design Purpose: Racing and Recreational
 Hull Weight : 105
 Hull Length: 96"
 Hull Width: 35"

HULL OPTIONS

Material Options: Fiberglass with epoxy resin for weight saving is standard. Carbon Fiber is an option for an additional cost.
Color Options: Black and White Standard, Metal Flake Colors are optional with an additional cost.
Graphics Included: The Bullett Racing Graphic Kits are optional with an additional cost.
Matting Included: Pre-Installed Jettrim Mats are optional with an additional cost.

Intended Fuel Tank: Standard Kawasaki OEM SXR Fuel Tank
Intended Intake Grate: Bullett Racing Single Bar Intake Grate
Intended Ride Plate: Bullett Racing Carbon Fiber Ride Plate
Scupper Valve: Pre-Drilled
Trim Tube: Yes
Number of Cooling Lines: 2
Exhaust Size: 2.5"

ENGINE AND PUMP SPECIFICATIONS

Engine Size Range Accepted: Kawasaki 800/1100
 Pump Size Range Accepted: Kawasaki 140mm – 145mm

Description	Part No.
V-2 Blaster Race Hull	BUL-K1105-2

Description	Part No.
V-2 Wide Body Hydrospace Hull	BUL-H1101-2

FOUR STROKE
 INTAKE SYSTEMS
 ENGINE/GASKETS
 EXHAUST
 DRIVE LINE HANDLING
 ELECTRICAL
 WATERLINE /BILGE
 STEERING & CONTROLS
 BODY
 ACCESSORIES
 SERVICE TOOLS /HARDWARE
 CHEMICAL

LAST MINUTE NEW PRODUCTS



WORX RACING BASEBALL STYLE CAP

Description WORX Racing Baseball Style Cap **Part No.** WR08002



RXP-X 255/260, RXT IS 260 RXT-X 255/RXT-X 260 GTX LTD 255/260 OE REPLACEMENT INTERCOOLER

OEM #276000319, #276000332

Description Sea-Doo 1503 Intercooler **Part No.** 010-7000K

STAINLESS STEEL BOLT KITS FOR RICKTER RRP HULL



Includes 8 stainless steel socket head bolts, 8 flat washers and 8 nylon nuts. This kit is for mounting the motor mounts to a Rickter adjustable engine plates

Description Rickter Motor Mount to Adjustable Engine Plates Bolt Kit **Part No.** 57-8010



Includes 3 stainless steel socket head bolts with 3 flat washers. These bolts are used for installing the Yamaha Superjet Midshaft Bearing Housing assembly to the bulkhead of a Rickter or aftermarket hull.

Description Midshaft Bolt Kit **Part No.** 57-8015



Includes 4 stainless steel bolts with 4 flat washers. The bolts are for securing the motors bed plate to the motor mount.

To properly install the engine and use this bolt kit you will need OEM large bed plate washers (*not included*).

Description Bed Plate To Motor Mount Bolt Kit **Part No.** 57-8020

FOUR STROKE	INTAKE SYSTEMS	ENGINE/GASKETS	EXHAUST	DRIVE LINE HANDLING	ELECTRICAL	WATERLINE /BILGE	STEERING & CONTROLS	BODY	ACCESSORIES	SERVICE TOOLS /HARDWARE	CHEMICAL
-------------	----------------	----------------	---------	---------------------	------------	------------------	---------------------	------	-------------	-------------------------	----------

HOT PRODUCTS CLOSE-OUT ITEMS

Below are special priced close-out items, they will be discontinued once sold out.

FOUR STROKE
INTAKE SYSTEMS
ENGINE/GASKETS
EXHAUST
DRIVE LINE HANDLING
ELECTRICAL
WATERLINE /BILGE
STEERING & CONTROLS
BODY
ACCESSORIES
SERVICE TOOLS /HARDWARE
CHEMICAL



AME WATERCRAFT GRIPS

Description
Yellow

Part No.
58-4006



SUPERJET HULL EXTENDER

Description
SuperJet 1996+ Side Only

Part No.
54-3472



JETTRIBE CLASSIC GOGGLES

Frame
Blue

Lens
Smoke

Part No.
JTA071303



JETTRIBE EXPERT GOGGLES

Frame
Skull Print

Lens
Smoke

Part No.
JTA12304



JETTRIBE VERTIGO RACE GLOVE

Vertigo Red Size
X-Large

Color
Black/Red

Part No.
JTG12410-VR-XL

JETTRIBE PWC COVERS



KAWASAKI

ULTRA 250X/LX (07-10), ULTRA 260 X,
ULTRA 260 LX (09-10) "Cruiser Seat", 300X, LX (11-12)
800 SX-R (03-12)

Part No.

KWS05018

KWS05008



BNJ BEARING STEERING SYSTEM FOR SXR/ZAPATA FZ

Description

BNJ Bearing Steering System for SXR/ZR

Part No.

BNJ-SXR



Black/Black
With 15"
Side Lifter

AP DESIGNS HYDROSPACE MATS

Hydrospace

Side Mat
Bottom for Kick Tail

Part No.

HYDROSPACESM
HYDROSPACEBMKT

HOT PRODUCTS CLOSE-OUT ITEMS

Below are special priced close-out items, they will be discontinued once sold out.



AP DESIGNS KAWASAKI 800 SXR SIDE MAT & BOTTOM MAT

Kawasaki	Part No.
Side Mat (no lifter)	KA800SXRSM
Bottom Mat	KA800SXRBM

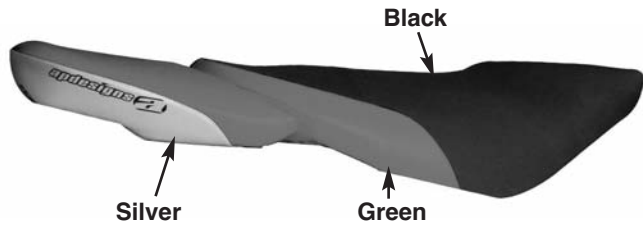

AP DESIGNS KAWASAKI ULTRA 250 SEAT COVER

Kawasaki	Part No.
Ultra Grip Top Black/Green/Silver	UKAU250-BK/GN/S



HYDRO-TURF BACK SUPPORT

Great for racing, recreational riding or just working around the house!
Light weight. Will not absorb water. Available in Black only.

Description	Size	Part No.
Black	S: 24-30	B20-BLK-S
Black	L: 35-42	B20-BLK-L



RIVA ALUMINUM TUBE SET AND BLOW-OFF VALVE

Aluminum Tube Upgrade Kit: Includes high-strength aluminum tubes with bolt-on adapter to accommodate our Performance Blow-off Valve (part# RS1750-BV-102). Adapter can be removed enabling use of Pro-series Blow-off Valve (part# RS1750-BV-PSV).

Description	Part No.
Upgrade Kit, Pro-Series Aluminum Tube Set (for RS1750-PC)	RS1750-PC-TK



MIKUNI OLD PARTS

Description	Part No.
A. Choke Lever Assembly for BN Carburetor	BN381/22
B. Nipple with Thread	VM34/181-1A
C. Super BN Carburetor Cover (USED ITEM)	BN44/147-USED



SPARK PLUG THREAD TIMING DIAL INDICATOR GAUGE

Description	Part No.
Timing Dial Indicator Gauge	59-5001



ARS GENUINE OIL SEAL

Description	Part No.
ARS Genuine Oil Seal for Mag Side of SD 580/650/720/785 30x62x7	FPJ630627GS

FOUR STROKE	ENGINE/ GASKETS	EXHAUST	DRIVE LINE HANDLING	ELECTRICAL	WATERLINE /BLIGE	STEERING & CONTROLS	BODY	ACCESSORIES	SERVICE TOOLS /HARDWARE	CHEMICAL
-------------	-----------------	---------	---------------------	------------	------------------	---------------------	------	-------------	-------------------------	----------

FOUR STROKE
INTAKE SYSTEMS
ENGINE/ GASKETS
EXHAUST
DRIVE LINE HANDLING
ELECTRICAL
WATERLINE /BILGE
STEERING & CONTROLS
BODY
ACCESSORIES
SERVICE TOOLS /HARDWARE
CHEMICAL

ADA Head & Dome	92, 134-136	Crank Shaft Parts, Sea-Doo.....	153
Adjust-A-Thrust	193	Crank Shaft Bearings.....	153
Afterburner Pump Cone.....	191	Crankshaft Oil Seal Kit.....	154
Air Pump.....	305	Dakine Foot Straps.....	284
Air/Fuel Ratio Kit	325	DASA Engine & Parts	88-89
Anchor. Anchor Bag.....	302-303	Davit Slings	310
Anti-Cavitation Cone.....	33, 57, 74, 193	Decals	289-290
Aqua Steps.....	291	Deep Fuel Pick Up, Kawasaki Ultra	63
Aquasocks Water Remover	312	D-Plate	170
Aquazooka	314	Drain Pans, Oil.....	328
Atlantis Enterprises Lanyard	292-293	Drive Coupler	55, 64, 83, 96, 205, 208, 214
Auto Trim Kit.....	56, 258	Drive Coupler Wrench	56, 96, 214, 321, 326
Banners	313	Drive Gear, Starter.....	226, 228
Battery Box Strap	229	Drive Shaft	96, 206, 210, 214
Battery Charger, Maintainer	229	Drive Shaft Bearing Housing	94, 206, 209, 216
Battery Connect & Battery Tester	229	Drop Nozzle Kit.....	82, 256
Beach Stand.....	310	Dry Pak Case and Bags.....	300, 301
Bilge Fitting.....	242	Dual Exhaust Kit.....	169
Bilge Pump, Hose, Bracket	242-243	Duck Bill Drain System	245
Bilge Sponge.....	245	DVD	314
Bilge Switch and Brackets	234, 244	ECU, Sea-Doo	6, 21
Binding System, Adjustable	84	ECU, Yamaha	47
Blow Off Sound Circulation.....	65	ECU Kawasaki.....	61
Blow Off Valve Kit	13, 40	ECU Reprogramming	6, 47, 61
Bomber Sunglasses	299	Engine Conversion Kit.....	94
Bolts & Nuts	316	Engine Keepers, Blowsion	131
Bow Stop, Stoltz	311	Engine Shims.....	131
Boyesen Reeds	117	Engine Tachometer	237
Brass Fittings.....	317	Engine Tech Supercharger Impeller	12, 38
Bulkhead Fitting	240	Enhancer	219
Bullett Hull.....	91	Exhaust Conversion Kit, K1100	93
Bumper	288	Exhaust Manifold Extender, Sea-Doo.....	19
Bungee Lite, Anchor	303	Exhaust Nozzle	287
Bunk Glides, Trailer.....	311	Exhaust Outlet, Exhaust Tip	19, 67, 172, 287
Buoy.....	303	Exhaust Power Sleeve	170
Burn Wetsuits, Vests, Gloves	296-298	Exhaust Valves & Parts	171
Butt Connectors	223	Exit Nozzle.....	194
Bypass Fitting.....	241	Factory Pipe Parts.....	166-168
Carb Screw Adjusting Tool	111, 322	Factory Zero Launcher & Parts.....	308-310
Carbon Tech Reeds	116	Filter Adapters	126
Carburetor Kit	93, 112-113	Filter Kit	6, 10-11, 36-37, 60, 127-129
Carburetor Linkage	107	Finger Throttle.....	82, 259-261
Carburetor Rebuild Kit.....	99, 110	Fishing Rack	309
Camshaft Chain	142	Fishing Rod Holder	310
Camshaft, Cam Gear	51	Flow Control Valve	172
Carrillo Connecting Rod.....	25, 49, 68	Flowguard, Pump	82
Catch Can/Oil Breather	10	Flush Kit.....	8, 75, 238-239
Charging Flywheel	95, 224	Flywheel	224
Check Valve, One Way	120	Flywheel Puller	224, 324
Chin Pad.....	78-79	Flyboard Impeller	174-175
Chin Pad Cover.....	272, 276	Foot Holds, Freestyle.....	84, 282
Clamps	125, 168, 242, 318	Free Flow Exhaust	7, 20, 44, 66, 170
Coil	218-219, 231-233	Freestyle Tail Cone.....	193
Compression Tester	323	Frogskin, Air Intake & Vent.....	130
Compartment Box	107	Front Sponsons.....	95, 202
Connecting Rod	25, 49, 68, 152-153	Fuel Filler, Filler Neck	287
Connectors, Electric.....	223	Fuel Filter	120-121
CP Piston	25, 48, 68	Fuel Injector.....	23, 46
Crank Pin Bearings	145	Fuel Line Hose.....	124, 318
Crank Shaft Assembly	154	Fuel Pick Up.....	93, 120

Fuel Pressure Regulator Kit.....	22, 45, 62
Fuel Pressure Regulator Block Off.....	45, 63
Fuel Pump Kit.....	23, 46, 62, 122
Fuel Tank.....	121
Fuel Tank Filter.....	120
Fuel Tuner.....	22
Fuel Valve.....	122
Funnel.....	5
Gas Cap.....	286
Gasket Set.....	24, 69, 155-160
Gloves.....	85, 332
Goggle Grip.....	295
Goggles, Bomber.....	299
Grips.....	262-265
Handle Bar.....	81, 248-249
Handle Bar End Caps.....	263
Handle Bar Extension Kits.....	9, 28, 55, 261
Handle Pole.....	76-77
Handle Pole Bracket.....	78
Handle Pole Pivot Bolt Bushing.....	88, 250
Handle Pole Shock Pad.....	269
Handle Pole Spring.....	253
Head.....	92, 134-138
Helix Tubing.....	124, 241, 318
Hitch Pin.....	311
Hood Clips, RRP.....	84
Hood Hand Hold Kit.....	285
Hood Hooks.....	284
Hood Insert.....	285
Hood Seals.....	85, 285
Hooker Impeller.....	190
Hood Latch.....	284
Hose Clamps.....	125, 168, 242, 318
Hose Pinches, Hose Removal Plier.....	125
Hose Shears.....	125
Hydro Turf Seat Cover.....	273-277
Hull Huger Fender.....	303
Hull Insert.....	201
Hunsaker Jugs.....	312
Hydrospace S4 Parts.....	95-96
Hydro Turf Mat & Sheet.....	270-274
Idle Gear.....	226, 228
Igni-Pro Ignition.....	221
Ignition System Spark Tester.....	325
Impeller.....	173-188, 190
Impeller Holder Tool.....	191, 316
Impeller Pitch Gauge.....	191, 326
Impeller Seal.....	181, 187
Impros Impellers.....	190
Individual Gasket.....	69, 155-165
Innovate Air/Fuel Ratio.....	325
Intake Manifold Block Off.....	18
Intake Grate.....	196-199
Intake Manifold.....	23, 93, 114-115
Intercooler.....	16, 17, 41
IPD Graphics.....	290
JE Piston.....	25, 48, 68
Jet Pump Housing (Yamaha).....	216
Jettrim Seat Cover.....	267-270
Jumper Cable.....	229, 325

K&N Flame Arrestors.....	128
Keel Protection, Gator Guards.....	288
Keihin Carb & Parts.....	110-111
Keihin Carb Rebuild Kit.....	110
Kick Tail.....	272, 276
Kommander Industries.....	93, 137
Lanyards.....	292-294
Leg Deflector.....	295
Life Jacket Vest.....	85, 296-298
LifeSled for PWC Rescue.....	306-307
Lizardskins Grips.....	264-265
Lock Rings for ODI Grips.....	263-264
Mikuni Carburetor Rebuild Kit.....	99
Mikuni Carburetors.....	98
Mikuni Jets, Needle & Seat.....	102
Mikuni Parts.....	99-108
Mirror Block Off.....	56, 75
Monkey Grip Motor Mount.....	132-133
Motor Mounts.....	95, 132-133, 149
MSD Electric Parts.....	218-222
Multi-Pressure Port Adaptor Kit.....	13, 39
Ninja Chin Pad.....	79
Nippon Denso Spark Plug.....	236
NGK Spark Plug.....	236
Nose Bushing.....	283
Novi-Tec.....	93, 112
Numbers Decals.....	289
O2 Sensor Mount Kit.....	19, 46
ODI Grips.....	262-263
Oetiker Clamp.....	125
Oil Extractor.....	5
Oil Filter.....	4
Oil Injection Block Off.....	130
One Way Fuel Check Valve.....	120
One Way Drain Valve.....	245-246
OPAS Block Off Kit.....	31
OPPAMA Tachometer.....	237
Outerwears Pre-filter.....	128
Piston.....	25, 48, 68, 140-149
Pop-Off Gauge.....	106, 322
Power Filter Kit, Riva.....	6, 11, 36, 60
Power Plenum Filter Kit, R&D.....	6, 10, 36, 60, 129
Powerfactor Exhaust.....	90
Powershot Fuel Tuner.....	22, 63
Pre-Filters.....	128
Primer Kit.....	123
Protorque Starter.....	228
Pro-X Pistons.....	148
PTO, Sea-Doo.....	208
Pulleys.....	64
Pump Bearing Housing, Kawasaki.....	206
Pump Cone, TBM.....	192
Pump, Flowguard.....	82, 256
Pump Housing Bearings, Sea-Doo.....	209
Pump Seal, Sea-Doo & Yamaha.....	212, 216
Pump Seal Kit, Pump Plug Kit.....	8, 52, 72, 197
Pump Shaft.....	207, 213-214
Pump Shoe.....	195
Pump Tail Cone.....	183, 189, 191-193
Pump Wedge Kit.....	32, 74, 194

FOUR STROKE
INTAKE SYSTEMS
ENGINE/ GASKETS
EXHAUST
DRIVE LINE HANDLING
ELECTRICAL
WATERLINE /BILGE
STEERING & CONTROLS
BODY
ACCESSORIES SERVICE TOOLS
HARDWARE
CHEMICAL

FOUR STROKE
INTAKE SYSTEMS
ENGINE/ GASKETS
EXHAUST
DRIVE LINE HANDLING
ELECTRICAL
WATERLINE /BILGE
STEERING & CONTROLS
BODY
ACCESSORIES
SERVICE TOOLS /HARDWARE
CHEMICAL

PWCDoctor.com, Versiplug	246	Switch Holder	29, 235
Quick Drain	245-246	Tachometers	237
Quick Loop.....	283	Tail Cone, Pump.....	183, 189, 191-193
Rail Cap, SXR.....	282	Tau Ceti Filters.....	127
Ratio Rite.....	312	T-Bolt Clamp	168, 318
Reduction Nozzle	32, 194	Telescoping Paddles	295
Reed	116-118	Terminal Detent Tool	222, 324
Reed Spacers	118	T-Fittings	123, 317
Registration Numbers	289	Three Bond	163, 329
Repair Manual	315	Throttle Cable Adapter.....	108
Rescue Sled.....	306-307	Throttle Cable Bracket, Cable Drum.....	108
Rickter Hull	86-87	Throttle Cables	109, 260
Rickter Wet Suit, Life Jacket	85	Throttle Lever	82, 259-261
Ride Plate	8, 53, 72, 87, 91, 95, 200-201	Thru Hull Fitting, Sea-Doo	208
Rotary Valve Parts	119	Tie Downs.....	311
Rule Bilge Pump.....	242	Tilt Cable	258
RRP Handle Pole	76, 77	Timing Advance Plate	225
Scupper Valve.....	84, 245	Tiny Tack	237
SE "Speed Magic" ...	54-55, 63, 67, 70-71, 204, 254-255, 259, 287	Top End Bearings	145
Seat Cover.....	267-277	Top End Rebuild Kits, WSM	150-151
Service Stand, Factory Zero.....	310	Top Stop Billet Steering.....	254
Service Tools	319-328	Tornado Filters.....	127
Shrink Butt Connectors	223	Total Loss Flywheel	218, 224
Siphon, Liquid Transfer	312	Tour Coat & Jacket.....	85, 298
Silicone Couplers	168	Total Loss Ignition System.....	218
Silicone Rubber Tape	221	Tow Hook, Transom Mount.....	305
Skat Trak Impeller	173-183	Tow Rope.....	304
Sleeve.....	25, 48, 139-144	Trailer Accessories	311
Slings.....	310	Trim Lever	257
Snap Hook.....	302, 307	Trim/Switch Housing, SD RXP,	29, 235
Solas Impeller.....	184-188	Trim System	82, 256
Solas Pump	189	Trim Tab, Sea-Doo	31
Solenoid Post, Kawasaki	227	Torx Socket & Bit Set for Sea-Doo	17, 320
Spark Guard, MSD.....	221	T-shirts.....	85, 314
Spark Plug.....	236	Tube Rope	304
Spark Plug Boots	220, 237	Turn Plate.....	80-81, 251
Spark Plug Gauge & Gapper	236, 325	Twin Impellers	34, 58, 73, 173-175
Spark Plug Retainer	220	Valve	26, 49, 68, 141
Spark Plug Wire	220	Valve Compression Tool	27, 49, 68, 320-321
Spark, Sea-Doo Parts.....	6-9	Velocity Stack Kit	129
Speed Control Override, Sea-Doo, Kawasaki	21, 47, 61	Versiplug Drain System	246
Spigot Mount Flange.....	106	V-Force Reed Kit.....	118
Splash Guard	288	Viewtainer.....	301
Sponsons	31-32, 54, 71, 202-204	Vi-Pec ECU.....	21, 47
Spring Tension Stand	78, 253	VTS Extension Rod	32, 258
Starter.....	227-228	VTS Quick Shift Cam Kit.....	56
Starter Relay	220, 229-230	Waste Gate Block Off Kit.....	65
Steering Cable	247, 251	Water Box	7, 19, 44, 66, 90, 169
Steering Cable Ball Joint.....	257-258	Water Restrictor.....	172, 240
Steering Nozzle.....	56, 256, 258	Water Strainer	240
Steering Stop	81, 252	Waterline Hose	124, 241, 318
Steering System - Runabout	8, 28, 55, 70, 254-255	Wave S.R.L. Products	95-96, 202
Steering System - Stand-up.....	80-81, 250-251	Wear Ring, Sea-Doo	212
Step, Aqua Step.....	291	Weatheright Connectors.....	222
Sunglasses.....	299	Wet Wolf Adjust-A-Thrust.....	193
Supercharger Clutch Washer, Sea-Doo	14-15	Whistle.....	293-294
Supercharger Sleeve, Sea-Doo	12	Wiseco Pistons	140-144
Supercharger Surge Protector.....	13, 40	Wossner Pistons	146-147
Supercharger Tool.....	15, 39, 320	Wrist Pin Bearings	145
Switch.....	233-235, 244	Zip Tie	316

2016 Quakysense
IJSBA World Finals
October 1st-9th, 2016
Lake Havasu City, Arizona USA



Hot Products is a IJSBA Associate Member and will have our VIP Booth at the 2016 IJSBA World Finals in Lake Havasu City, Arizona USA.

For information on becoming a member of the IJSBA, racing information, IJSBA rulebook, and more...

Please visit
www.IJSBA.com



New for 2015 Pro Rider Digital Subscriptions
Receive 6 issues that you can read online or download to your tablet, smartphone, or laptop.
Visit <http://www.proridermag.com> for complete information

Pro Rider is published 6 times per year and Hot Products has a supply of each issue available for sale at a special price and the magazines can be shipped with your Hot products parts order.

Pro Rider Watercraft Magazine tells the stories of the personal watercraft industry from a core and revolutionary "pro rider" perspective. As the sport's premier U.S. publication, Pro Rider Watercraft Magazine celebrates the unique variety of talent that continues to preserve, represent, and evolve the personal watercraft action sports experience. Whether you are a competitor, industry leader, or weekend warrior, Pro Rider Watercraft Magazine offers fresh insight and personal perspectives on what's happening in the most exciting and extreme water sport on the planet.

The personal watercraft industry is constantly redefining itself as it continues to grow and prosper. Pro Rider Watercraft Magazine establishes itself as the essential source of information and inspiration for our sport.

Description	Part No.
Pro Rider Magazine	PRORIDER

Back issues also available. Call for availability.

"What this world needs is a website that speaks to the heart, soul and needs of a watercraft rider." - H. Clinton



How-To Videos • News • Events • Product Reviews

FOUR STROKE	INTAKE SYSTEMS	ENGINE/GASKETS	EXHAUST	DRIVE LINE HANDLING	ELECTRICAL	WATERLINE /BILGE	STEERING & CONTROLS	BODY	ACCESSORIES	SERVICE TOOLS /HARDWARE	CHEMICAL
-------------	----------------	----------------	---------	---------------------	------------	------------------	---------------------	------	-------------	-------------------------	----------

HOT PRODUCTS IS A PROUD SUPPORTER OF CORNERSTONE

OPERATION SADDLE UP

A Project of Cornerstone Therapeutic Riding Center



NOVEMBER 11TH IS VETERAN'S DAY • MAKE A DIFFERENCE • MAKE A DONATION

Cornerstone launched "Operation Saddle Up" in response to the tremendous need for alternative therapies for wounded service members. We have served over 450 combat injured men and women. The results are extraordinary.

The annual program cost of Operation Saddle Up is \$75K. Cornerstone receives no government funding and relies on the generosity and financial support of our community.

Your tax-deductible donation directly benefits programs and does not support administrative costs.

Cornerstone is a 501c3 non-profit organization.



760.788.2872
www.cornerstonetrc.org

FOUR
STROKE

INTAKE
SYSTEMS

ENGINE/
GASKETS

EXHAUST

DRIVE LINE
HANDLING

ELECTRICAL

WATERLINE
/BILGE

STEERING
& CONTROLS

BODY

SERVICE TOOLS
ACCESSORIES

/HARDWARE

CHEMICAL



Day With the Pros

October 2th 2016
8AM - 12 PM

Find Us At:

 World Finals Starting Line

- Learn from the Pros
- Hang with the Pros
- Ride with the Pros

Sign up online NOW!
ProWatercraft.com



Starts at 8
Get Here Early

Exciting NEW Stations



Awesome Giveaways



JR Star Awards





2016 Hot Products Cover Featured and Sponsored Racer Mark Gomez • Professional Jetski Athlete Freeride • Freestyle • Closed Course Racer • Vintage Racer

As a kid, Mark religiously watched Larry Rippenkroeger, Scott Watkins and Chris Fischetti tear up surf in the VHS movie *Jet Dreams*. He first started riding in the surf on a Kawasaki 550sx in 2004, his freshman year of high school.

His first step into the industry was when he got a job working for Pacific Motorsports in Brea, California. This job allowed him to learn how to work on jetskis and supported his growing freeride addiction.

Over the next few years, while riding in Oceanside, California's premier location, he met riders and friends that inspired him to push his riding to levels beyond his expectations. Many of the Oceanside regulars, like Ross Champion, Randy Laine, Mike Serlin, Taylor Curtis, Jeremy Fleming, John Howe, Matt Smith, Zack Bright and JFB, all became close friends and still ride together. This group of friends set a great example and took the time to work with Mark to convey what it takes to be a pro, secure sponsorships and, most importantly, how to represent these sponsors.

By the time he graduated high school, he had made it his goal and priority to become a professional jetski athlete. The first step in this process was achieved when Wamiltons Customs responded to a sponsorship request



letter. Through a generous customer, a beat up 2004 Yamaha SuperJet project became his first big break into the competitive freeride scene. After many freerides, trials and errors, his first major event victory came at the 2009 Blowsion Surfslam, Freeride Champion.

After years of riding, progressing in abilities, sponsorships, competitions, event attendance and experience in the closed course racing discipline, it came time to get the equipment required to compete against the top freeriders around the world. A sponsorship agreement was signed with Rick Roy and his company Rickter-RRP, beginning a great relationship.

A Rickter hull and RRP parts are the highest quality in the industry, but Mark needed the parts assembled into the best Rickter possible, able to put up with all of the slamming abuse of riding. It was a very simple decision, Taylor Curtis at TC Freeride would build the complete Rickter.

In 2015, equipped with the TC Freeride Rickter Edge, Mark set his sights on the 2015 IFWA Freeride World Title. Supported by incredible sponsors and his family, and with consistent and exceptional performance from the Rickter hulls, Mark traveled through tour stops in Australia, Portugal, France and the UK,



on his way to the finals in Oregon, USA. At the finals, he was able to ride his best and achieve the 2015 IFWA World Title!

Mark's 2016 plans are to travel the world attending and competing in more than 20 events, in all four disciplines, Freeride, Freestyle, Closed Course Racing and Vintage Racing

Aside from competitive jetskiing, Mark works part-time at Universal Studios Hollywood, performing as an X2 riding villain in a live action stunt show. He has also made appearances in a national Adidas television commercial, and in the intro of a DreamWorks movie.

Without the support of his family and all of his valued sponsors, many of his achievements would not have been possible.



2015 Sponsors:



For more information about Mark Gomez please visit:
www.MarkGomez.net • [instagram.com/markgomez137](https://www.instagram.com/markgomez137) • [facebook.com/MarkaGomez](https://www.facebook.com/MarkaGomez)



HOT

PRODUCTS

2016

WWW.HOTPRODUCTSUSA.COM

SALES: 858-453-4454

FAX: 858-453-2046

8830 REHCO ROAD #F SAN DIEGO, CA 92121

\$10.00 USD