

## SEA DOO

## KAWASAKI



### SUPER BN MANUAL

For the watercraft tuner working with Super BN series carburetors.

Description	Part No.
Mikuni Manual	53-9999

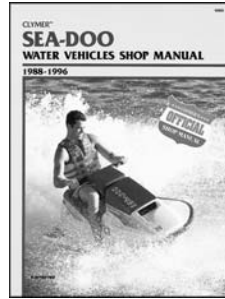

Sea Doo Water Vehicles  
1988-1996

Standard GT, GTS, GTX,  
SP, SPI, XP

**Part No. W809-3**

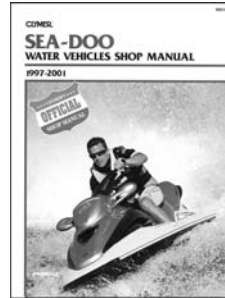

Sea Doo Water Vehicles  
1997-2001

GS/GSI/GSX/GSX RFI/  
GSX Ltd./GTI/GTS/GTX  
GTX DI/GTX RFI/GTX Ltd.  
HX/LRV/RX/RX DI  
SP/SPX/XP Ltd.

**Part No. W810**



Kawasaki Jet Ski  
1976-1991

JS300, JS550, JS300SX,  
JS550SX, JS400, JF650X-2,  
JS440, JS650SX, JF650TS,  
JL650SC, JB650TS Jet Mate

**Part No. W801**

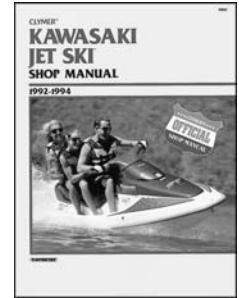

Kawasaki Jet Ski  
1992-1994

JS440, JS550, JS550SX,  
JB650 Jet Mate, JF650X-2,  
JF650TS, JL650SC,  
JS650SX, JH750SS,  
JS750SX, JH750Xi,  
JT750ST, JH750XIR

**Part No. W802**



Kawasaki Jet Ski  
Performance Manual,  
all models 1976-1994

**Part No. W804**

## YAMAHA

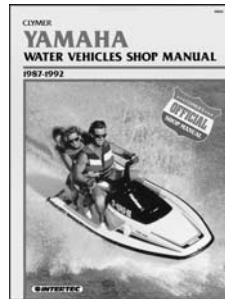

Yamaha Water Vehicles  
1987-1992

WJ500, WRA650, WR500,  
SJ650, WR650

**Part No. W805**

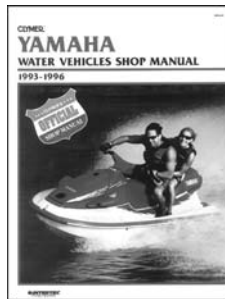

Yamaha Water Vehicles  
1993-1996

WR500, SJ650, WR650,  
WRA650, WRA650A,  
WRB650, WRB650A, FX700,  
SJ700, RA700, RA700A,  
RA700B, WB700A, WRA700,  
WRB700, WVT700, RA760,  
WB760, RA1100, WVT100

**Part No. W806**

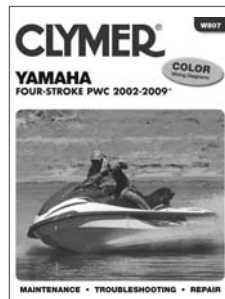

Yamaha Water Vehicles  
Four Stroke 2002-2009\*

05-08 FX, 05-08 FX Cruiser  
04-08 FX Cruiser High Output  
04-08 FX High Output, 02-04 FX140  
02-04 FX140 Cruiser, 05-09 VX  
05-09 VX Cruiser, 05-09 VX Deluxe  
05-09 VX Sport

**Part No. W807**

\*Does not cover 1800 cc models. Does not cover 2-stroke models.

## POLARIS

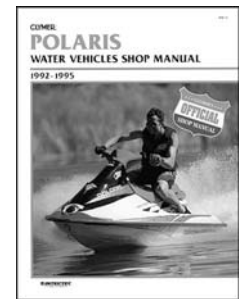

Polaris Water Vehicles  
1993-1995

SL650, SL750, SLT750

**Part No. W819**

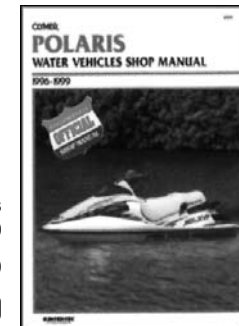

Polaris Water Vehicles  
1996-1999

SL650, SL750, SLT750

**Part No. W820**

FOUR  
STROKE

INTAKE  
SYSTEMS

ENGINE/  
GASKETS

EXHAUST

DRIVE LINE  
HANDLING

ELECTRICAL

WATERLINE  
/BILGE

STEERING  
& CONTROLS

BODY

ACCESSORIES

SERVICE TOOLS  
/HARDWARE

CHEMICAL

FOUR STROKE  
INTAKE SYSTEMS  
ENGINE/GASKETS  
EXHAUST  
DRIVE LINE HANDLING  
ELECTRICAL  
WATERLINE /BILGE  
STEERING & CONTROLS  
BODY  
ACCESSORIES  
SERVICE TOOLS /HARDWARE  
CHEMICAL

## METRIC STAINLESS STEEL HEX BOLT PACKS

10 Pcs Per Pack



Size/mm	Part No.
6 x 10	60-3010
6 x 12	60-3012
6 x 14	60-3014
6 x 16	60-3016
6 x 18	60-3018
6 x 20	60-3020
6 x 25	60-3025
6 x 30	60-3030
6 x 35	60-3035

Size/mm	Part No.
6 x 40	60-3040
6 x 45	60-3045
6 x 50	60-3050
6 x 60	60-3060
6 x 70	60-3070
6 x 80	60-3080
8 x 18	60-4018
8 x 20	60-4020

Size/mm	Part No.
8 x 25	60-4025
8 x 30	60-4030
8 x 35	60-4035
8 x 40	60-4040
8 x 50	60-4050
8 x 60	60-4060
8 x 80	60-4080
10 x 25	60-5025

## METRIC STAINLESS STEEL SOCKET HEAD CUP BOLT PACKS

10 Pcs Per Pack



Size/mm	Part No.
4 x 30	61-1030
4 x 16	61-1016
5 x 10	61-2010
5 x 25	61-2025
6 x 10	61-3010
6 x 12	61-3012
6 x 14	61-3014

Size/mm	Part No.
6 x 16	61-3016
6 x 20	61-3020
6 x 25	61-3025
6 x 30	61-3030
6 x 35	61-3035
6 x 40	61-3040
6 x 50	61-3050

Size/mm	Part No.
6 x 60	61-3060
8 x 20	61-4020
8 x 25	61-4025
8 x 30	61-4030
8 x 50	61-4050
8 x 60	61-4060
10 x 25	61-5025

## METRIC STAINLESS STEEL NUTS

10 Pcs Per Pack



Size	Part No.
6mm	63-0006
8mm	63-0008

## METRIC STAINLESS STUD PACKS

10 Pcs Per Pack



Size/mm	Part No.
8 X 30	62-4030

## METRIC STAINLESS STEEL FLAT WASHERS

10 Pcs Per Pack



Size	Part No.
6mm	63-2006
8mm	63-2008
10mm	63-2010

## METRIC STAINLESS STEEL SPRING WASHERS

10 Pcs Per Pack



Size	Part No.
6mm	63-4006
8mm	63-4008
10mm	63-4010

## ZIP TIES



Description	Color	Part No.
3 3/4" x .090	Black	64-0050
7 1/4" x 1.190	Black	64-0051

(Sold in Packages of 100)

## PLASTIC FITTINGS



Plastic T Fitting	Part No.
3/8" x 3/8" x 3/8"	64-0025
1/2" x 1/2" x 1/2"	64-0027

Plastic Y Fitting	Part No.
3/8" x 3/8" x 3/8" (white)	64-0045
1/4" x 1/4" x 1/4" (white)	64-0046
1/4" x 1/4" x 1/4" (black)	64-0047

# BRASS FITTINGS



Straight Hose Barbed	Part No.
1/8" Thread 1/4" Hose	64-0001
1/8" Thread 3/8" Hose	64-0003
1/4" Thread 1/2" Hose	64-0005



Barb Connector	Part No.
1/4" I.D. Hose-1/4" I.D. Hose	64-0057
3/8" I.D. Hose-3/8" I.D. Hose	64-0058
1/2" I.D. Hose-1/2" I.D. Hose	64-0059



Brass Push in Nipple	Part No.
1/8" Straight	53-9936
1/4" Straight	53-9937



90 Degree	Part No.
1/8" Pipe thread 3/8" Hose	64-0007
1/4" Pipe thread 1/2" Hose	64-0009
1/8" Pipe thread 1/4" Hose	64-0010



Garden Hose Adapter	Part No.
3/8"	64-0012
1/2"	64-0014



Press-in 90 Degree Fuel Inlet	Part No.
1/4" 90 Degree	44



45 Degree	Part No.
1/8" Pipe thread 1/4" Hose	64-0065
1/8" Pipe thread 3/8" Hose	64-0066
1/4" Pipe thread 1/2" Hose	64-0067



Brass Fitting	Part No.
1/8" Pipe threaded junction	64-0011
1/8" to 1/4" Adapter	64-0013
9mm Yamaha Flush Adapter	64-0004



T-Fitting	Part No.
Primer Fitting 1/8" x 1/8" x 1/8"	64-0015
Primer 1/4" x 1/4" x 1/8"	64-0017
Fuel Line 1/4" x 1/4" x 1/4"	64-0019



Brass Threaded Plug	Part No.
1/8" Threaded Plug	64-0016
1/4" Threaded Plug	64-0018



2007 WORLD FINALS • LAKE HAVASU, AZ  
PHOTO COURTESY OF JIN OMURA

FOUR STROKE	INTAKE SYSTEMS	ENGINE/GASKETS	EXHAUST	DRIVE LINE HANDLING	ELECTRICAL	WATERLINE /BILGE	STEERING & CONTROLS	BODY	ACCESSORIES SERVICE TOOLS /HARDWARE	CHEMICAL
-------------	----------------	----------------	---------	---------------------	------------	------------------	---------------------	------	-------------------------------------	----------

FOUR  
STROKEINTAKE  
SYSTEMSENGINE/  
GASKETS

EXHAUST

DRIVE LINE  
HANDLING

ELECTRICAL

WATERLINE  
/BILGESTEERING  
& CONTROLS

BODY

ACCESSORIES

SERVICE TOOLS  
/HARDWARE

CHEMICAL



## STAINLESS STEEL HOSE CLAMPS

Clamps	Max. Size	Part No.
#5	(for waterline)	64-0030
#36	2 3/4" - 1 13/16	64-0032
#48	3 1/2" - 2 9/16	64-0031
#60	4 1/4" - 3 5/16	64-0033
#72	5 - 4 1/16	64-0034
#80	5 1/2" - 4 9/16	64-0035



## T-BOLT CLAMPS

Size	Width	Part No.
3"	3/4"	64-0080
3-1/4"	3/4"	64-0081
4-1/2"	3/4"	64-0082
5"	3/4"	64-0084
5-1/4"	3/4"	64-0085
5-1/2"	3/4"	64-0086



## HOSE SHEARS

Scissor-action cutter for hose.

Description	Part No.
Hose Shears	59-4020



## FUEL LINE

Fuel line is made from a thick walled polyurethane tubing. Sold per foot. or 25 feet/pk

Description	Part No.
Blue (1/4") per foot	53-9970
Blue (1/4") 25 feet package	53-9970-25
Primer Line (1/8") per foot	53-9980
Primer Line (1/8") 25 feet package	53-9980-25

## Fast, Easy, Strong and Secure Installation



## SQUEEZE ON STAINLESS STEEL LOW PROFILE CLAMPS

Oetiker Stepless Ear Clamps, due to the reinforcing 'dimple' in the ear, hold against pressure and vibration or hose shrinkage due to temperature changes. A built-in spring action permits the clamp to "breathe" without loosening, the need to retighten is eliminated. Once installed, any tampering is easily visible, making this an excellent clamp for service or security applications.

## Fast & Easy Removal

Description	Clamp Size	Part No.
Pincer Tool	-	59-4015
Clamp for 1/4" Hose (10 pcs/pk)	9/16	59-4016
Clamp for 3/8" Water Line (10 pcs/pk)	11/16	59-4017
Clamp for 1/2" Water Line (10 pcs/pk)	13/16	59-4018

100 Clamp Packs	Clamp Size	Part No.
Clamp for 1/4" Hose (100 pcs/pk)	9/16	59-4016-100
Clamp for 3/8" Water Line (100 pcs/pk)	11/16	59-4017-100
Clamp for 1/2" Water Line (100 pcs/pk)	13/16	59-4018-100

## FLEX-TECH WATER LINE HOSE



Flex-Tech multi purpose hose is more flexible and bendable for those complicated water routing requirements. This waterline is highly recommended for Factory

and TBM Dry Pipe installations. Waterline is sold per foot.

Description	Part No.
3/8" Flex-Tech Light Blue Waterline Hose	56-8010

## WATER LINE HOSE



Goodyear hose has been replacing rubber hose or metal tubing designs. Goodyear hose and tubing offers customers a

number of benefits, including flexibility, durability, abrasion resistance, lighter weight materials, superior chemical resistance, high pressure capability, and extended product performance. Waterline is sold per foot.

Description	Part No.
3/8" Blue	56-8000
1/2" Blue	56-8004
3/8" Clear Vinyl*	56-8007

\*Clear vinyl hose is not manufactured by Goodyear.

500 foot reel 3/8" blue hose available and  
400 foot reel 1/2" blue hose available  
**Call for special pricing on reel purchases.**

# FUEL SYSTEM SERVICE TOOLS



## CARB SCREW ADJUSTING TOOL

Angled head for the hard-to-reach carb adjustment screws

Description	Part No.
Carb Screw Adjusting Tool	53-9994

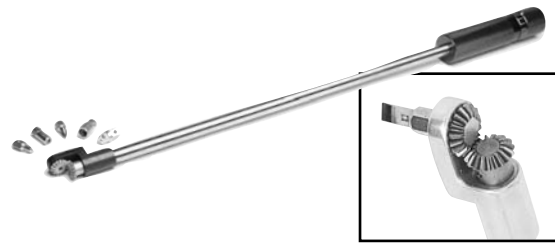

## 90 DEGREE 1/4" HEX DRIVER

Precision made of high-grade aluminum & stainless steel. Designed for hard-to-reach pilot screw. Gear driven 1/4" hex. Includes 1/4" hex bits, straight slot, Phillips, D-shaped pilot screw bit, 6mm hex jet bit and 1/4"-hex-to-1/4" drive bit.

Description	Part No.
90 Degree 1/4" Hex Driver	08-0229

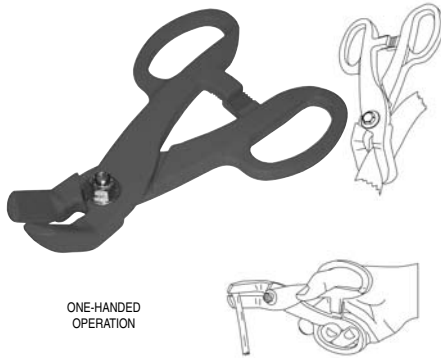

ONE-HANDED OPERATION

## HOSE PINCHER

Clamps and holds hoses up to 3/4" inside diameter. Angled jaws close to create a complete seal every time. Jaws are offset for hard-to-reach areas. The handles lock firmly to hold the jaws in closed position.

Description	Part No.
Hose Pinchers	LS23000

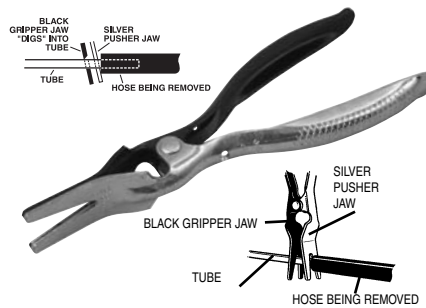

## HOSE REMOVAL PLIERS

For easy removal of 5/32" to 1/2" (4mm to 14mm) hoses. Engage the tube (line) with the black jaw. This sharpened jaw actually "digs" into the tube to grip it! Squeeze, and the hose is easily pushed off by the silver jaw.

Description	Part No.
Hose Removal Pliers	LS47900

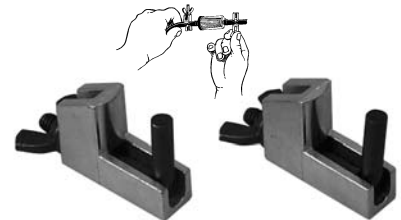

## HOSE PINCHERS

Quick, easy way to pinch off fuel lines, etc. without damaging the line. Sold two per set.

Description	Part No.
Hose Pinchers	LS22850



## MIKUNI TOOL KIT

This handy little kit contains all the tools necessary to make jetting change, perform normal maintenance as well as disassemble and rebuild any Mikuni carburetor

Description	Part No.
Mikuni Tool Kit	53-9989



## ROTARY VALVE TIMING WHEEL

Description	Part No.
Rotary Valve Timing Wheel	012-170

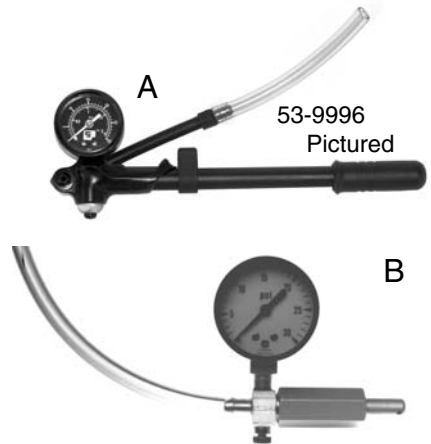

## POP-OFF GAUGE

For Accurate adjustment of pop off pressure levels.

Description	Part No.
A Mikuni Gauge	
30 Lbs.	53-9996
60 Lbs.	53-9996-60
100 Lbs.	53-9996-100
B Aftermarket Thumb Operated Gauge	53-9995

FOUR STROKE  
INTAKE SYSTEMS  
ENGINE/GASKETS  
EXHAUST  
DRIVE LINE HANDLING  
ELECTRICAL  
WATERLINE /BILGE  
STEERING & CONTROLS  
BODY  
ACCESSORIES SERVICE TOOLS /HARDWARE  
CHEMICAL

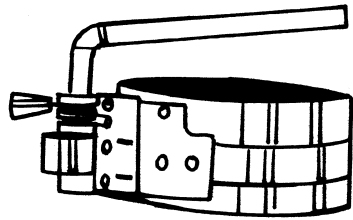

## QUICK RELEASE RING COMPRESSOR

Ring Compressor makes it easy to remove ring from piston. Range is from 2-1/8" – 5" (54mm–127mm).

Description	Part No.
Quick Release Ring Compressor	LS19000

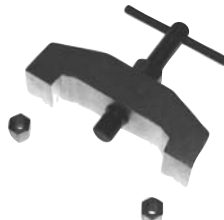

## HEAD PULLER FOR KAWASAKI HEADS

Pull straight up from the spark plug hole while using the studs for leverage.

Description	Part No.
Head Puller for Kawasaki	59-0209

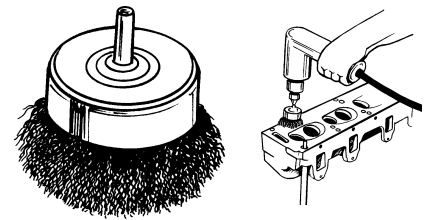

## 2-1/2" WIRE CUP BRUSH

Removes weld scale, rust, paint and corrosion from metal surfaces. Made with .014 carbon steel wire and designed for light duty use with an electric drill. Maximum safe free speed is 4500rpm.

Description	Part No.
2-1/2" Wire Cup Brush	LS14020

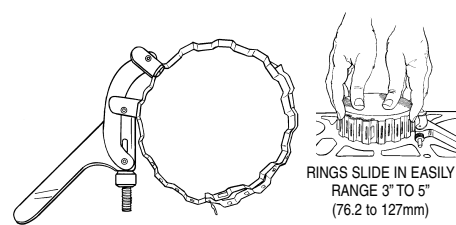

## WRINKLE BAND RING COMPRESSOR

Wrinkle band cuts friction in half. Rings slide in easily 3" – 5" (76.2mm – 127mm).

Description	Part No.
Wrinkle Band Ring Compressor	LS21700



## SEAL PULLER

Simply insert the tip of the tool behind the oil or grease seal, press and pull. Leverage works for you. Two size tips reach in and fit nearly all seal applications.

Description	Part No.
Seal Puller	LS56750

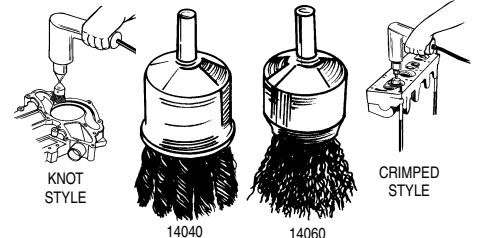

## 1" WIRE END BRUSHES

Made with .020" industrial heat-tempered wire. Use with portable electric and air tools. 20,000rpm maximum safe speed.

Description	Part No.
1" Knot Wire End Brush	LS14040
1" Crimped Wire End Brush	LS14060

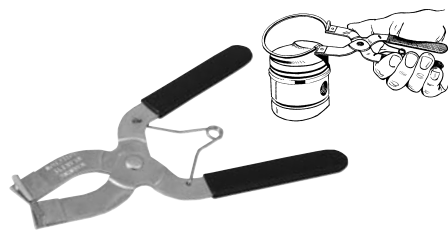

## PISTON RING INSTALLER

Description	Part No.
Piston Ring Installer	LS33500

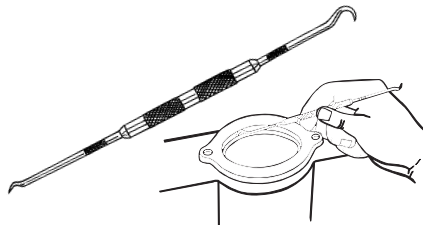

## "O" RING AND SEAL PICK

Quickly removes and installs "O" rings and seals. Tips are hardened to stay sharp.

Description	Part No.
"O" Ring and Seal Pick	LS31840



## PISTON PIN PULLER

Universal piston pin puller easily removes all sizes of piston pins without any damage to the piston.

Description	Part No.
Piston Pin Puller	59-0252

## CONVERSION TABLE

Unit	Conversion
<b>Linear Measure</b>	
centimeter (cm.)	0.3937 inch
meter (m.)	3.2808 feet / 1.0936 yards
kilometer (km.)	0.6214 mile
inch (in.)	2.54 centimeters
foot (ft.) = 12 inches	30.48 centimeters
yard (yd.) = 3 feet	0.914 centimeters
rod (rd.) = 5.5. yards	5.0292 meters
chain (ch.) = 4 rods	20.117 meters
furlong (fur.) = 10 chains	201.17 meters
mile (m., mi.) = 8 furlongs	1.6093 kilometers
league (l.) = 3 miles	4.8279 kilometers
<b>Aviordupois Weight</b>	
Gram (g.)	0.0353 oz. avdp.
kilogram (kg.) = 1,00 grams	2.2046 lb. avdp
metric ton (M.T.)	1.1023 short tons
	0.9842 long ton
grain (gr.)	0.0648 gram
dram (dr. avdp.) = 27.34 grains	1.7718 grams
ounce (oz. avdp.) = 16 drams	28.3495 grams
pound (lb. avpd) = 16 ounces	0.4536 kilogram
<b>hundredweight (cwt.)</b>	
(US) = 100 pounds	45.3592 kilograms
(UK) = 112 pounds	50.8024 kilograms
<b>ton (t., tn.)</b>	
(US) = short ton	
=2,000 pounds	0.907 metric ton
(UK) = short ton	
=2,240 pounds	1.106 metric ton



2007 WORLD FINALS • LAKE HAVASU, AZ  
PHOTO COURTESY OF JIN OMURA

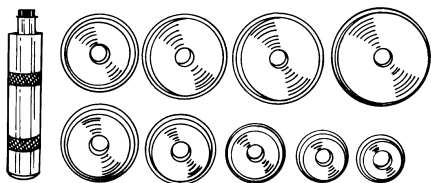

SET INCLUDES ONE OF EACH OF THE FOLLOWING DRIVERS:

DRIVER PART NO.	SIZE
12610	1.565"
12620	1.750"
12630	1.965"
12640	2.325"
12710	2.470"
12650	2.555"
12690	2.830"
12700	2.995"
12970	3.180"

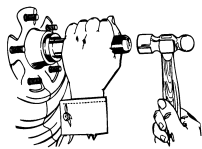

## BEARING RACE AND SEAL DRIVER—MASTER SET

Make it easier to insert bearing race and seals without damage to race. This master set includes nine drivers to fit most standard bearings.

Description	Part No.
Bearing Race and Seal Drive	LS12980
Handle Mini pouched	LS12660



## COMPRESSION TESTER

Contains hoses for 10, 12 & 14mm spark plug applications. Features a quick disconnect with a pressure release valve and a 300lbs. Gauge. Packed in a convenient carry box. Made in USA.

Description	Part No.
Compression Tester	08-0188

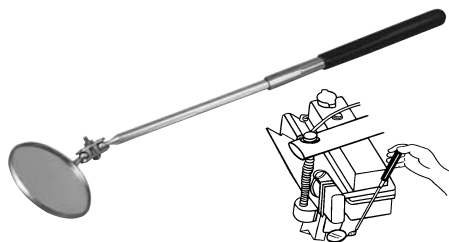

## TELESCOPING MIRROR

Enables you to see around corner. 2-1/4" diameter mirror swivels to any position. Length extends from 10" to 14".

Description	Part No.
Telescoping Mirror	LS32050



## JUMPER CABLES

8 feet long heavy duty 8 gauge copper jumper cables are big on charging power, yet stow conveniently in the 9 x 9 inch nylon bag.

Description	Part No.
Jumper Cables	59-0530



## SPARK PLUG TOOLS

Description	Part No.
Ratchet Plug Wrench	59-0539



## SPARK PLUG WIRE TESTER

Now you can check spark plug wires without piercing the wires. Light flashes indicating sound wire.

Description	Part No.
Spark Plug Wire Tester	LS26900
Replacement Bulb Assembly	LS26970



## IGNITION SYSTEM SPARK TESTER

This ignition system tester checks the integrity and strength of your system by gauging your systems spark.

Description	Part No.
Ignition System Spark Tester	59-0253

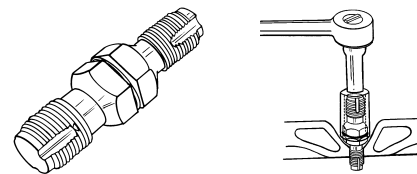

## SPARK PLUG HOLE THREAD CHASER

Cleans threads in spark plug hole. Use with 13/16" spark plug socket. Double-ended for both 14mm and 18mm threads.

Description	Part No.
Spark Plug Hole Thread Chaser	LS20200

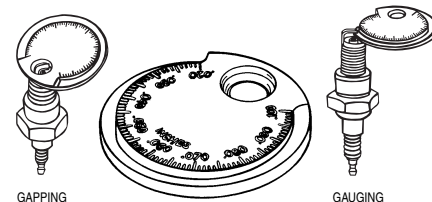

## STANDARD/HIGH ENERGY SPARK PLUG GAUGE AND GAPPER

Gauge and gap all types of spark plugs from .020" to .110 (.50mm to 2.53mm).

Description	Part No.
Spark Plug Gauge and Gapper	LS67870

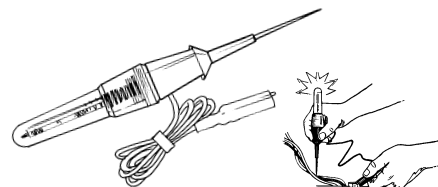

## LOW CIRCUIT TESTER

Quick check both AC and DC current up to 28 volts with power on. Helps locate shorts or breaks in wiring. Complete with insulated grounding grip.

Description	Part No.
Low Circuit Tester	LS26250
Replacement Bulb	LS26270



## SPARK PLUG HOLDERS

Spark Plug Holder protects the electrode, maintaining the proper gap.

Description	Part No.
2 per blister pack	SPH-2
40 per countertop display	SPH-40

FOUR STROKE

INTAKE SYSTEMS

ENGINE/GASKETS

EXHAUST

DRIVE LINE HANDLING

ELECTRICAL

WATERLINE /BILGE

STEERING & CONTROLS

BODY

ACCESSORIES

SERVICE TOOLS /HARDWARE

CHEMICAL



## PRO-CRIMP TOOL

To do a job right, it is important to have the right tools. If you custom build a lot of plug wires, the Pro-Crimp is the right tool for you! The Pro-Crimp features a hardened steel frame, molded hand grips and built-in ratchet action that is also adjustable. The tool is supplied with jaws to fit MSD's Super Conductor Spark Plug wires and can be removed to use additional jaws (sold separately) for crimping common wiring terminals.

Description	Part No.
MSD Pro Crimp Tool	3505
Spark Plug Dies	3508
Amp Pins	3506
Amp Lug Dies	3507
Weathertight Dies	3509
Deutsch Terminal Dies	3510



## TERMINAL DETENT TOOL

The hollow barrel allows you to depress the tab on the terminal end and to remove the wire from the connector without damaging its ends.

Description	Part No.
Terminal Detent Tool	59-0254

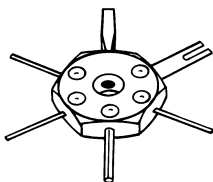

## TERMINAL REMOVAL TOOL

Includes six different shaped blades.

Description	Part No.
Terminal Removal Tool	LS14900



## PERMA-SEAL CONNECTOR KIT

Description	Part No.
MSD Perma-Seal Connector Kit	4377



## TIMING LIGHTS

MSD offers a heavy duty top quality timing light. This timing light is supplied in a heavy duty metal housing and features a high output Linear Xenon strobe with a focused fresnel lens that produces a light that's bright enough to use outdoors. It is equipped with a 6 foot lead and uses a metal inductive pickup that clamps to the spark plug wire.

Description	Part No.
Timing Light	8990



## TDC DIAL INDICATOR KIT

Perfect for indicating TDC (Top Dead Center) when setting ignition and rotary valve timing. CNC-machined spark plug hole (14mm) adapter. 1" travel dial indicator. Rotating Bezel. Measures in .001" increments.

Description	Part No.
TDC Indicator	MT-DIAL



## TIMING DEGREE WHEEL

Set total loss timing with no guess work. Check crank shaft timing to exact degree. A must for porting and port timing.

Description	Part No.
Timing Degree Wheel	08-0092



## FLYWHEEL PULLER

Description	Part No.
Sea Doo 800/951 38mm x 1.5	MP#42
Kawasaki 900/1100 35mm x 1.5	DS#29

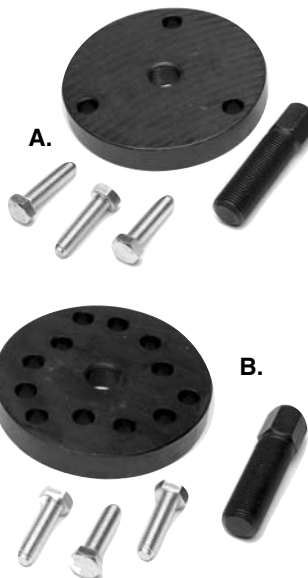

## MAGNETO FLYWHEEL PULLER

Sea Doo	Part No.
A. 580/650/720	DS#34
3 Hole Disc 8mm Bolts	

Polaris	Part No.
B. Polaris ALL & Universal	DS#37
Universal 12 Hole Disc 8mm Bolts	

YAMAHA	Part No.
B. 500/650/Pre 94 701	DS#37
Universal 12 Hole Disc 8mm Bolts	
B. 701/760/800/1100/1200	DS#37
Universal 12 Hole Disc 8mm Bolts	

KAWASAKI	Part No.
B. 300/440/550/650	DS#37
Universal 12 Hole Disc 8mm Bolts	



C. 750/800 Special	MP#18
18mm x 1.5	
Right Hand Bolt	





# PUMP SYSTEM SERVICE TOOLS AND BATTERY CHARGERS



## IMPELLER HOLDER TOOL

Sea Doo	Part No.
A. 580/650/720/800/951 All 18mm spline	DS#23
POLARIS	Part No.
B. Polaris ALL & long reach univ.	DS#38



## IMPELLER HOLDER TOOL

Sea Doo	Part No.
K. GTX 4Tec Super Charged	DS#70
L. RXP/RXT 27MM	DS#71



## DRIVE COUPLER TOOLS

Use to remove drive coupler from crankshaft and sub-shaft.

Description	Part No.
650/701	DS#60-3
760/800/110/1200	DS#61-5



## SOLAS IMPELLER HOLDER TOOL

Sea Doo	Part No.
RXP/RXT 27MM	WR012-SRX

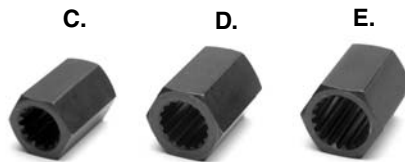

## IMPELLER SHAFT HOLDER TOOL FOR YAMAHA

Yamaha	Part No.
C. WR500, WJ650LX 16mm spline	DS#27
D. 650/701/760/1100/1200 18mm spline	DS#32
E. GP1200R 20mm spline	DS#56



## IMPELLER HOLDER TOOL FOR KAWASAKI

Kawasaki	Part No.
F. 440/550-89 16mm spline	DS#24
G. 650/750/900/1100 18mm spline	DS#23



## MAINTAINER MODEL #CU2602

Total Amps: 0.5  
Battery System: 12Volt



## CHARGER MODEL #CU2606A

Total Amps: 6  
Battery System: 12Volt

## MAINTAINER MODEL #CU2603

Total Amps: 3  
Battery System: 12Volt



## CHARGER MODEL #CU2612A

Total Amps: 10  
Battery System: 12Volt



## GUEST 12 VOLT MAINTAINERS AND PORTABLE BATTERY CHARGERS

AMPS	TYPE	PART/MODEL #	TERMINATION	DIMENSIONS	CHARGING CABLE LENGTH	AC/WALL CABLE LENGTH	WEIGHT
.5	Maintainer	CU2602	Alligator Clips	1.5" x 3.0" x 2.0"	4'	6' w/Standard Plug	.5LBs
3	Charger	CU2603	Alligator Clips	3.1" x 3.5" x 2.34"	4'	6' w/Standard Plug	1LBs
6	Portable	CU2606A	Alligator Clips	5.5" x 5.0" x 2.4"	4'	6' w/Standard Plug	3.5LBs
10	Portable	CU2612A	Alligator Clips	7.5" x 5.0" x 2.4"	4'	6' w/Standard Plug	4.5LBs

FOUR STROKE  
INTAKE SYSTEMS  
ENGINE/GASKETS  
EXHAUST  
DRIVE LINE HANDLING  
ELECTRICAL  
WATERLINE /BILGE  
STEERING & CONTROLS  
BODY  
ACCESSORIES  
SERVICE TOOLS /HARDWARE  
CHEMICAL

FOUR  
STROKE

INTAKE  
SYSTEMS

ENGINE/  
GASKETS

EXHAUST

DRIVE LINE  
HANDLING

ELECTRICAL

WATERLINE  
/BILGE

STEERING  
& CONTROLS

BODY

ACCESSORIES

SERVICE TOOLS  
/HARDWARE

CHEMICAL



## VALVE COMPRESSION TOOL SD 4-TEC

Our overhead Valve Compression Tool allows easy removal of valve springs and keepers without removing cylinder head. Includes compression adapter to pressurize cylinder keeping valves in place during removal of stock springs and keepers.

**Description** Tool, Valve Compression, SD 4-TEC **Part No.** RS19050-VCT

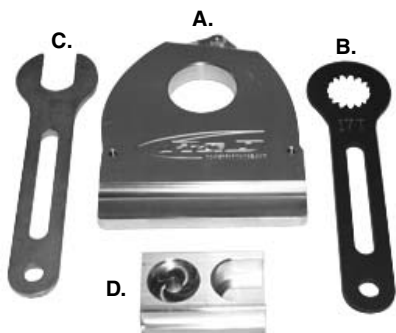

## R&D RXP SC REBUILD TOOL KIT

R&D has designed a custom tool kit that is essential in the rebuilding process of the SeaDoo Supercharger. All tools are specific in application and are cnc machined to ensure a precision job.

Description	Part No.
185 Horsepower Tool Kit*	613-96001
215 Horsepower Tool Kit*	613-96002
A. Supercharger Holder Tool	613-96005
D. Bearing Puller/Installer Tool	613-96006
4-Pin Socket	613-96007
Seal/Bearing Retainer Torx Wrench	613-96008
B. 215HP 16 Tooth Drive Gear Tool	613-96016
B. 185HP 17 Tooth Drive Gear Tool	613-96017
C. 185HP Clutch drive / Lock Washer Tool	613-96018
C. 215HP Clutch drive / Lock Washer Tool	613-96019

\*NOTE: Kit comes with a S/C holder, bearing puller/installer tool, drive gear tool and clutch drive/lock washer tool.



## RIVA SEADOO SUPERCHARGER SHAFT HOLDER TOOL

Our SeaDoo Supercharger Shaft Holder Tool makes servicing your supercharger a snap. Ergonomically designed billet handle allows a sure, firm grip without fatiguing your hand. Working ends are made from heat treated tool-grade steel to resist wear and are oversized to prevent flexing. A must for every mechanic's tool box!

**Description** RIVA SeaDoo SC Shaft Holder Tool **Part No.** RS1750-ISH-949



## TORX® SOCKET SET FOR SEA DOO

Special Star Sockets for Sea Doo 4-Tec & DI engine bolts are made from heat-treated vanadium steel and black oxide coated for durability. Sockets are kept in a convenient vinyl holder.

- Four 3/8" Drive Sockets (T10, T12, T14, T16)
- Three 1/4" Drive Sockets (T6, T7, T8)

**Description** Torx Socket Set **Part No.** LS26750



## SCRATCH BRUSH

Removes rust, scale, paint, and solder from metal surfaces.

**Description** I. Shoe Handle Scratch Brush **Part No.** LS14180  
J. Scratch Brush **Part No.** LS14160



## PARTS CLEANING BRUSH

**Description** Parts Cleaning Brush **Part No.** LS14000



## SUPER OUT SET

A super strong extractor set made of a special hardened, shock-resistant tool steel. Works on both left and right hand threads. Super Outs cut their way straight into bolts, eliminating wedging or further tightening of frozen bolts and screws. Five extractor sizes extract 1/4" to 1/2" and larger bolts and screws.

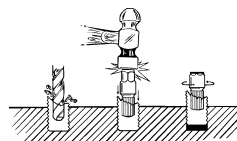

**Description** Super Out Extractor Set **Part No.** LS62900



## 3/8" HAND IMPACT TOOL SET

Loosens Rusted, Frozen Nuts, Bolts and Screws. Unique design delivers over 200 ft. lbs. of "Shock Torque." Can be reversed to tighten. Can also be used with impact sockets!



29200	Impact Set Includes:
29000	3/8" Impact Tool
29520	3/8" Bit Holder
29630	#1 Phillips Bit
30180	#2 Phillips Bit
29550	#3 Phillips Bit
30190	#4 Phillips Bit
30170	3/8" Straight Slot Bit

**Description** 3/8" Hand Impact Tool Set **Part No.** LS29200

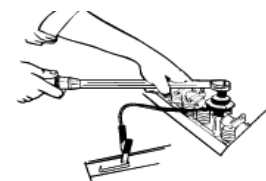

## TORQUE ANGLE METER

For All Torque-to-Yield Fastener Applications. Commonly used for tightening head bolts & other bolts where a torque angle is required. Use with 1/2" drive.

**Description** Torque Angle Meter **Part No.** LS28100



## LISLE CREEPER SEAT/STEP

Ergonomic design with a 300lb. capacity that can be rotated forward onto rubber feet to make a stable 14" tall ladder. Spacious storage tray below the seat keeps tools, test equipment and parts within easy reach. Perfect for PWC service, PWC pump repairs, etc. Wheels pop into tubular steel

legs with an outrigger design for added stability.

<b>Description</b>	<b>Part No.</b>
Lisle Creeper Seat/Step	LS93402



## RULE FLAT TANK ELECTRIC OIL EXTRACTOR

Eliminate those costly yard service fees with the new quick, clean, compact electric oil extractor. Includes a 3-1/2 gallon compact self-priming diaphragm pump for extraction and an easy pour spout for oil transfer.

- 3.5 gallon (13 liter) leak proof container
- Designed for ease of carrying

- Complete with dipstick, suction tube & battery clamps
- Empties and stows easily
- Self-priming, dry running, 12 or 24 volt diaphragm pump

<b>Description</b>	<b>Part No.</b>
Electric Oil Extractor	17860-0012



## HYDRO-TURF OIL EXTRACTOR

The unit uses a small vacuum system, which pumps fluid through a hose to the 6-liter reservoir. It also includes a pour spout to aid in emptying the reservoir. Pump is removable for easy storage.

<b>Description</b>	<b>Part No.</b>
Hydro-Turf Oil Extractor	OIL01

## MOELLER MARINE PRODUCTS FLUID EXTRACTOR

- Empties oil in 15 pumps or less
- Extracts warm or cold oil
- Pressure relief valve allows easy transportation and storage
- Single-hand-ease effortless operation
- Delivers gulp-free, mess-free performance
- Complete adapter kit is included featuring three extraction tubes
- Tethered cap

<b>Description</b>	<b>Part No.</b>
Moeller Oil Extractor (6.5 Liter Fluid Extractor)	MR07398
Moeller Fluid Extractor Tube Replacement Kit	MR08032

\*Note: Not for use with gasoline.

USA Patent #5450924 - Germany Patent #29500683.8 - U.K. Patent #2272948 Australia Patent #674469 - Taiwan Patent #113238 - China Patent #ZL92241981.7



## SHOP LANYARD

Not legal for riding. For shop testing only.

<b>Description</b>	<b>Part No.</b>
KPTW, Yamaha, Sea Doo	A3240
KPTW, Yamaha, Sea Doo DESS	A3250



## RATIO RITE CUP & LID

<b>Description</b>	<b>Part No.</b>
Ratio Cup	59-0548
Ratio Rite Cup Lid	59-0582

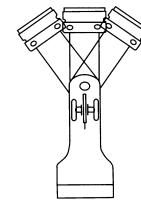

Locks in 3 Different Positions.

## FOLD-UP SCRAPER

The fold-up scraper features three arm positions and a slanted blade for proper scraping. Great for removing decals, etc.

<b>Description</b>	<b>Part No.</b>
Fold-up Scraper	LS52400

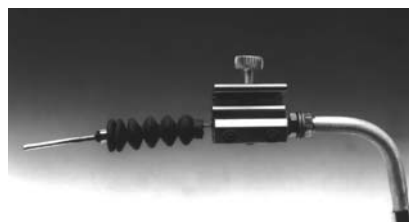

## CABLE LUBBER

Installs quickly and helps free up corroded or tight cables. Note; Damaged cable should be replaced.

<b>Description</b>	<b>Part No.</b>
Cable Lubber	59-0250

FOUR STROKE	ENGINE/ GASKETS	EXHAUST	DRIVE LINE HANDLING	ELECTRICAL	WATERLINE /BILGE	STEERING & CONTROLS	BODY	ACCESSORIES SERVICE TOOLS /HARDWARE	CHEMICAL
-------------	-----------------	---------	---------------------	------------	------------------	---------------------	------	-------------------------------------	----------

FOUR  
STROKE

INTAKE  
SYSTEMS

ENGINE/  
GASKETS

EXHAUST

DRIVE LINE  
HANDLING

ELECTRICAL

WATERLINE  
/BILGE

STEERING  
& CONTROLS

BODY

SERVICE TOOLS  
ACCESSORIES

/HARDWARE

CHEMICAL



## STUD TOOL

Economy stud installation and removal tool. The kit includes three sizes: 6mm, 8mm and 10mm.

Description	Part No.
Economy Stud Tool Kit	WJ7710



## STUD INSTALLATION TOOLS

Will install cylinder and intake manifold studs. Hex head is 3/4" or 19mm.

Description	Part No.
6mm x 1.00 Stud Tool	59-0212
8mm x 1.25 Stud Tool	59-0213
10mm x 1.25 Stud Tool	59-0214



## HEX-PRO AND STAR-PRO PIVOT HEAD WRENCHES

- Pivot design allows for easy rotation around obstructions
- Heat treated alloy tool steel
- Includes heavy duty folding canvas storage pouch

Description	Part No.
Hex-Pro Metric	08-0420
Hex-Pro SAE	08-0419
Star-Pro	08-0421



## T-HANDLE RATCHET

Features a compact design that allows it to be used even in tight spaces.

Description	Part No.
1/4" T-Handle Ratchet	08-0231
3/8" T-Handle Ratchet	08-0226

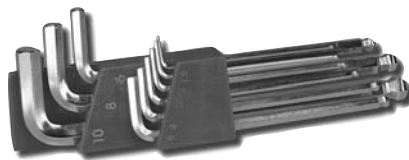

## BALL END ALLEN SET

Made of chrome-vanadium tool steel. Size available 1.5, 2, 2.5, 3, 4, 5, 6, 8, & 10mm. Ball end allows for better access to allen-head bolts (up to 25 degree working angle.)

Description	Part No.
Ball End Allen Set	08-0185



## T-HANDLE ALLEN WRENCH

Description	Part No.
5mm - 6" long T-Handle	59-0307
5mm - 9" long T-Handle	59-0309
8mm - 9" long T-Handle	59-0311



## DOC ALLEN'S VERSATOOL

- Lightweight
- Compact
- Multi-Function
- Stainless Steel
- Use in Tight Places

Description	Part No.
Compact Tool Set	VERSATOOL



## MAGNETIC SOCKET HOLDERS

Standard and deep sockets fit on one convenient holder with powerful magnets, securely holding on to any steel surface. Red color only.

Description	Part No.
1/4" Holder with 26 compartments	LS40120
3/8" Holder with 28 compartments	LS40200

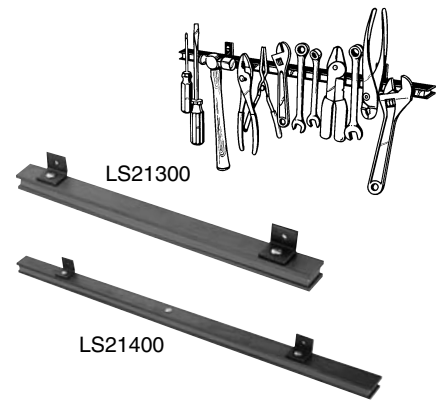

## MAGNETIC TOOL HOLDERS

Powerful magnet holds even heavy hand tools. Ideal for both home and shop.

Description	Part No.
13" long Magnetic Tool Holder	LS21300
24" long Magnetic Tool Holder	LS21400

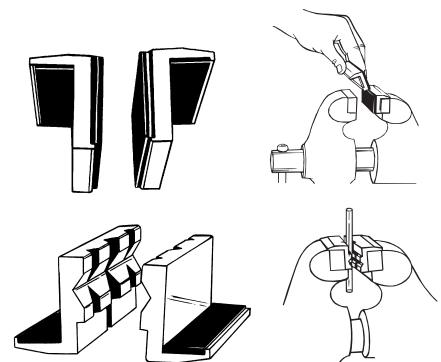

## RUBBER-FACED & ALUMINUM VISE JAW PADS

These vise jaw pads are designed to protect delicate parts from damage. Sold in pairs.

Description	Part No.
A. Rubber-faced Vise Jaw Pads	LS48100
B. Aluminum Vise Jaw Pads	LS48000